

Multiplierless decimation filters based on amplitude sharpening and compensation

Dudarin, Aljoša

Doctoral thesis / Disertacija

2019

Degree Grantor / Ustanova koja je dodijelila akademski / stručni stupanj: **University of Zagreb, Faculty of Electrical Engineering and Computing / Sveučilište u Zagrebu, Fakultet elektrotehnike i računarstva**

Permanent link / Trajna poveznica: <https://urn.nsk.hr/urn:nbn:hr:168:596477>

Rights / Prava: [In copyright](#)/[Zaštićeno autorskim pravom.](#)

Download date / Datum preuzimanja: **2024-09-02**



Repository / Repozitorij:

[FER Repository - University of Zagreb Faculty of Electrical Engineering and Computing repository](#)





University of Zagreb
FACULTY OF ELECTRICAL ENGINEERING AND COMPUTING

Aljoša Dudarin

**MULTIPLIERLESS DECIMATION FILTERS BASED
ON AMPLITUDE SHARPENING AND
COMPENSATION**

DOCTORAL THESIS

Zagreb, 2019



University of Zagreb

FACULTY OF ELECTRICAL ENGINEERING AND COMPUTING

Aljoša Dudarin

**MULTIPLIERLESS DECIMATION FILTERS BASED
ON AMPLITUDE SHARPENING AND
COMPENSATION**

DOCTORAL THESIS

Supervisors:

Professor Mladen Vučić, Ph.D.

Adjunct Assistant Professor Goran Molnar, Ph.D.

Zagreb, 2019



Sveučilište u Zagrebu
FAKULTET ELEKTROTEHNIKE I RAČUNARSTVA

Aljoša Dudarin

**DECIMACIJSKI FILTRI BEZ MNOŽILA TEMELJENI
NA IZOŠTRAVANJU I KOMPENZACIJI
AMPLITUDE**

DOKTORSKI RAD

Mentori:
Prof. dr. sc. Mladen Vučić
Nasl. doc. dr. sc. Goran Molnar

Zagreb, 2019

Doktorski rad izrađen je na Sveučilištu u Zagrebu Fakultetu elektrotehnike i računarstva, na Zavodu za elektroničke sustave i obradbu informacija.

Mentori:

Prof. dr. sc. Mladen Vučić

Nasl. doc. dr. sc. Goran Molnar

Doktorski rad ima: 96 stranica

Doktorski rad br.: _____

About the Supervisor

Mladen Vučić was born in Karlovac in 1965. He received B.Sc., M.Sc. and Ph.D. degrees in electrical engineering from the University of Zagreb, Faculty of Electrical Engineering and Computing (FER), Zagreb, Croatia, in 1989, 1993 and 1999, respectively.

From March 1989 he has been working at the Department of Electronic Systems and Information processing at FER. In 2001 he was promoted to an Assistant Professor, in 2006 to an Associate Professor, in 2011 to a Professor and in 2016 to a Full Professor. He led three scientific and one research project and participated in four projects funded by the Ministry of Science and Technology of the Republic of Croatia. He also participated in one EU FP7 project. Currently, he participates in the project *Beyond Nyquist Limit* funded by Croatian Science Foundation and in the project *DATA-CROSS - Advanced Methods and Technologies for Data Science and Cooperative Systems* funded by EU Structural and Investment Funds. He published more than 50 papers in journals and conference proceedings in the area of circuit theory, analog and digital signal processing, optimization theory and applications, digital system design, and embedded systems.

Mladen Vučić is a member of IEEE and KoREMA. From 2013 to 2016 he was serving as the chair of *IEEE Circuits and Systems Chapter Croatia*. From 2016 to 2018 he was Head of the Department of Electronic Systems and Information Processing at FER. In 1997, Mladen Vučić was awarded from the Ministry of Defence and the Ministry of Science and Technology of the Republic of Croatia by the *Annual award for scientific contribution to the development and strengthening of the defence system of the Republic of Croatia*.

O mentoru

Mladen Vučić rođen je u Karlovcu 1965. godine. Diplomirao je, magistrirao i doktorirao u polju elektrotehnike na Sveučilištu u Zagrebu, Fakultetu elektrotehnike i računarstva (FER), 1989., 1993. odnosno 1999. godine.

Od ožujka 1989. godine radi na Zavodu za elektroničke sustave i obradbu informacija FER-a. Godine 2001. izabran je u znanstveno-nastavno zvanje docenta, 2006. u zvanje izvanrednog profesora, 2011. u zvanje redovitog profesora, a 2016. u zvanje redovitog profesora u trajnom zvanju. Dosad je vodio tri znanstvenoistraživačka i jedan tehnologijski istraživačko razvojni projekt, te je kao istraživač sudjelovao na još četiri znanstvenoistraživačka projekta Ministarstva znanosti i tehnologije Republike Hrvatske. Također, bio je istraživač na jednom EU FP7 projektu. Trenutno je istraživač na znanstveno istraživačkom projektu *Iznad Nyquistove granice* financiranom od Hrvatske zaklade za znanost te na projektu *DATA CROSS - Napredne metode i tehnologije u znanosti o podacima i kooperativnim sustavima* financiranom iz Europskih strukturnih i investicijskih fondova. Objavio je više od 50 radova u časopisima i zbornicima konferencija u području teorije električnih krugova, analogne i digitalne obrade signala, teorije i primjene optimizacijskih postupaka, dizajna digitalnih sustava te ugradbenih računalnih sustava.

Prof. Vučić član je udruga IEEE i KoREMA. Od 2013. do 2016. godine bio je predsjednik Odjela za električne krugove i sustave Hrvatske sekcije IEEE. Od 2016. do 2018. godine bio je predstojnik Zavoda za elektroničke sustave i obradbu informacija FER-a. Godine 1997. godine dobio je *Godišnju nagradu za sveukupne znanstveno-istraživačke doprinose razvoju i jačanju sustava obrane Republike Hrvatske*, koju su zajednički dodijelili Ministarstvo obrane i Ministarstvo znanosti i tehnologije Republike Hrvatske

About the second supervisor

Goran Molnar was born in Zagreb in 1978. He received the Diploma Engineer and Ph.D. degrees in electrical engineering from the University of Zagreb, Faculty of Electrical Engineering and Computing (FER), in 2001 and 2010. He received the *Silver medal Josip Lončar* from FER for outstanding Ph.D. thesis and *Award for Young Scientists Vera Johanides* from the Croatian Academy of Engineering for 2010th year, for the research in the field of synthesis and implementation of systems for analog and digital signal processing.

In 2001 he was employed as a Teaching and Research Assistant at the Department of Electronic Systems and Information Processing at FER. In 2010 he was employed as a Senior Teaching and Research Assistant at the same department. From 2001 to 2013 he participated in three scientific and one research project funded by the Ministry of Science and Technology of the Republic of Croatia. In 2013 he had the position of Experienced Researcher at *Centre of Research Excellence for Advanced Cooperative Systems (ACROSS)* funded by EU FP7 framework. In 2014 he was employed as a Senior FPGA Engineer and Project Leader at the electronic company Xylon. Since 2015 he works at the Research and Development Centre of Ericsson Nikola Tesla d.d., where he participates in two educational and research collaboration-projects between FER and Ericsson Nikola Tesla d.d. in the development of 4G/5G radio access networks, entitled *Improvements for LTE Radio Access Equipment (ILTERA)* and *Emerging Wireless and Information Technologies for 5G Radio Access Networks (EWITA)*. In 2017 he was promoted to a Scientific Adviser in the area of technical sciences, scientific field of electrical engineering. In 2018 he was promoted to an Adjunct Assistant Professor at FER. He published more than 30 papers in journals and conference proceedings in the fields of filter theory and design, analog and digital signal processing, communication systems, optimization theory and applications, and digital system design.

Goran Molnar is a member of IEEE. Since 2018 he has been serving as the chair of *IEEE Signal Processing Chapter Croatia*.

O drugom mentoru

Goran Molnar rođen je u Zagrebu 1978. godine. Diplomirao je i doktorirao u polju elektrotehnike na Sveučilištu u Zagrebu, Fakultetu elektrotehnike i računarstva (FER), 2001. i 2010. godine. Za istaknutu doktorsku disertaciju i posebno uspješan znanstveno-istraživački rad dobio je *Srebrnu plaketu Josip Lončar*. Za svoj znanstveno-istraživački rad u području sinteze i implementacije sustava za analognu i digitalnu obradu signala, uručena mu je *Nagrada mladom znanstveniku Vera Johanides* Akademije tehničkih znanosti Hrvatske za 2010. godinu.

Godine 2001. zapošljava se kao znanstveni novak na Zavodu za elektroničke sustave i obradbu informacija FER-a. Godine 2010. zapošljava se kao viši asistent na istom zavodu. Od 2001. do 2013. godine sudjeluje u radu na tri znanstveno-istraživačka i jednom tehnologijsko istraživačko razvojnom projektu Ministarstva znanosti i tehnologije Republike Hrvatske. Godine 2013. zapošljava se kao istraživač na infrastrukturnom europskom projektu *Centre of Research Excellence for Advanced Cooperative Systems (ACROSS)* financiranog iz EU FP7 okvirnog programa. Godine 2014. zapošljava se kao razvojni FPGA inženjer i voditelj industrijskih projekata u elektroničkoj tvrtci Xylon d.o.o. Od 2015. godine do danas, radi u Istraživačko-razvojnom centru kompanije Ericsson Nikola Tesla d.d. gdje sudjeluje u radu na dva projekta obrazovne i znanstveno-istraživačke suradnje između FER-a i Ericssona Nikole Tesle d.d. u području razvoja 4G/5G radijskih pristupnih mreža, pod nazivima *Poboljšanje karakteristika rada LTE radijskih pristupnih uređaja (ILTERA)* i *Nove bežične i informacijske tehnologije za 5G radijske pristupne mreže (EWITA)*. Godine 2017. izabran je u znanstveno zvanje znanstveni savjetnik u znanstvenom području tehničkih znanosti, polje elektrotehnika. Godine 2018. izabran je u naslovno znanstveno-nastavno zvanje docenta na FERu. Objavio je više od 30 radova u časopisima i zbornicima konferencija u području teorije i sinteze filtara, analogne i digitalne obrade signala, komunikacijskih sustava, teorije i primjene optimizacijskih postupaka te dizajna digitalnih sustava.

Goran Molnar član je udruge IEEE. Od 2018. godine predsjednik je Odjela za obradu signala Hrvatske sekcije IEEE.

ABSTRACT

The simplest multiplierless decimation filter is the cascaded-integrator-comb (CIC) filter. However, CIC filters introduce a passband droop, which is intolerable in many applications. The droop can be reduced by connecting a linear-phase finite-impulse-response filter called compensator in cascade with CIC filter. Since CIC filters are multiplierless, CIC compensators with multiplierless structures are preferable. In the thesis, two methods for the design of multiplierless CIC compensators have been proposed. Both methods are based on minimization of the maximum passband deviation. However, the first method provides an efficient compensation by using coefficients expressed as sums of powers of two (SPT), whereas the second method brings simple compensator's structures by representing each coefficient as signed power of two. In both approaches, the optimum coefficients are found by using global optimization. In processing of wideband signals, CIC filter is often incapable of meeting the requirement for high folding-band attenuations. To improve CIC filter folding-band response, various structures have been developed. An efficient structure arises from polynomial sharpening of the folding-band response. This structure implements a so-called sharpened CIC (SCIC) filter. To obtain very high folding-band attenuations of SCIC filters, the minimax sharpening of the folding bands is proposed. In addition, to obtain multiplierless SCIC structures, polynomials with SPT coefficients are used. However, the SCIC response also introduces a high passband droop. The droop can be reduced by connecting a compensator in cascade with the SCIC filter. For the multiplierless SCIC filters, multiplierless compensators are preferable. In the thesis, two approaches for design of multiplierless SCIC compensators are proposed. The first approach brings a closed-form method based on maximally flat approximation. Such an approximation is suitable for narrowband SCIC filters. The second approach results in a global method based on the minimization of the maximum passband deviation. This method is preferable for wideband SCIC filters.

Keywords: cascaded-integrator-comb (CIC) filters, compensation, decimation, finite-impulse-response (FIR) filters, maximally flat approximation, minimax approximation, multiplierless, sharpening, signed power of two, sum of power of two (SPT)

Decimacijski filtri bez množila temeljeni na izoštravanju i kompenzaciji amplitude

Tijekom posljednja dva desetljeća, programski definiran radio postao je nezaobilazna tehnologija koja je prodrla u mnoge dijelove modernih komunikacijskih sustava. Popularnost ove tehnologije posljedica je mogućnosti programski definiranih prijamnika da podržavaju razne komunikacijske standarde koristeći isto sklopovlje. Programski definirani prijamnici temelje se na algoritmima za digitalnu obradu signala (*Digital Signal Processing*, DSP). Ovi algoritmi se uobičajeno implementiraju koristeći procesore te je njihova upotreba ograničena na niže frekvencije. Stoga se za obradu signala na ulazu u prijamnik često koristi integrirano sklopovlje dizajnirano za specifičnu primjenu. Međutim, razvoj programibilnih logičkih polja (*Field Programmable Gate Arrays*, FPGA) omogućio je korištenje DSP algoritama i u području međufrekvencija.

Programski definiran radio prijamnik s kanonskom arhitekturom sadrži antenu te sklopove za analognu predobradu, analogno-digitalnu pretvorbu, digitalno-analognu pretvorbu te digitalnu obradu signala. Nažalost, zbog ograničenja trenutno dostupnih komponenata, programski definiran radio prijamnik u praksi je puno složeniji. Signal koji dolazi s antene se prvo filtrira koristeći niskopropusni filter kako bi se potisnule komponente signala izvan Nyquistovog područja. Dobiveni signal se zatim atenuira koristeći programibilni atenuator te pojačava pojačalom s konstantnim pojačanjem kako bi se osigurala prihvatljiva razina signala na ulazu u analogno-digitalni pretvornik (*Analog to Digital Converter*, ADC). Nakon ADC-a, signal se obrađuje u digitalnom sklopovlju koje obavlja transpoziciju signala, filtriranje kanala, automatsku regulaciju pojačanja, demodulaciju te druge zadaće potrebne za dobivanje izlaznog signala.

Prijamnik s uzorkovanjem u osnovnom frekvencijskom području ima arhitekturu najbližijoj kanonskoj. Nakon niskopropusnog filtra signal se vodi na ADC. Kompleksna ovojnica se dobiva u digitalnoj domeni množenjem signala iz ADC-a s kompleksnom eksponencijalom koju daje numerički upravljani oscilator (*Numerically Controlled Oscillator*, NCO). Nakon množila, kompleksan signal se vodi na decimacijski filter koji se koristi za spuštanje frekvencije uzorkovanja. Nakon decimacije, signal prolazi kroz kanalski filter. Signal koji odgovara željenom kanalu dalje obrađuje sustav za automatsku regulaciju pojačanja (*Automatic Gain Control*, AGC) koji se koristi za prilagođavanje razine signala. Na kraju, ovisno o modulaciji, demodulator će obraditi kompleksni signal koji daje AGC sklop.

Decimacijski filtar neizostavan je dio digitalnog prijamnika. Tijekom desetljeća, razvijene su razne metode i strukture u području dizajna decimacijskih filtara uzimajući u obzir njihovu složenost, potrošnju i brzinu. Konačno, poseban naglasak je stavljen na dizajn decimatora s visokim svojstvima koji u realizaciji ne koriste množila opće namjene.

Najjednostavniji decimacijski filtar bez množila koji podržava visoke faktore pretvorbe frekvencije uzorkovanja sastoji se od kaskade integratorskih i češljastih sekcija (*Cascaded Integrator-Comb*, CIC). Međutim, CIC filtri visokog reda imaju veliki pad amplitudne karakteristike u području propuštanja, koji često nije prihvatljiv. Ovaj pad može se smanjiti spajanjem filtra s konačnim impulsnim odzivom (*Finite-Impulse-Response*, FIR) i linearnom fazom, zvanog CIC kompenzator, u kaskadu sa CIC filtrom. Moguć je i drugačiji pristup. Na primjer, u programski definiranom prijamniku kompenzatori se mogu ugraditi u FIR kanalski filtar koji dolazi neposredno iza decimacijskog filtra. U ovakvom pristupu se prijenosna funkcija filtra dobiva konvolucijom impulsnog odziva kompenzatora i polaznog kanalskog filtra. Prijenosna funkcija CIC kompenzatora može se dobiti i korištenjem klasičnih metoda za dizajn FIR filtara. Ove metode implementirane su u većini standardnih alata za obradu signala. Na primjer, MATLAB podržava dizajn CIC kompenzatora korištenjem kriterija jednolike valovitosti i kriterija najmanjih kvadrata.

S obzirom na to da CIC filtri ne sadrže množila, preferiraju se i CIC kompenzatori koji ih ne sadrže. U literaturi se odvojeno razmatraju uskopojasni i širokopojasni kompenzatori bez množila. U posljednjem desetljeću razvijene su razne metode za njihov dizajn, pokrivajući pritom kompenzatore s dva, tri, pet i proizvoljnim brojem koeficijenata. Budući da kompenzatori s neparnim brojem koeficijenata forsiraju konstantnu amplitudu u širem frekvencijskom području nego kompenzatori s parnim brojem koeficijenata, uglavnom se koriste kompenzatori s neparnim brojem koeficijenata.

U mnogim aplikacijama koriste se CIC kompenzatori s tri koeficijenta bez množila. Oni su učinkoviti u uskim frekvencijskim područjima. Za širokopojasne aplikacije koje zahtijevaju značajno manju valovitost amplitude, prikladniji su kompenzatori s više od tri koeficijenta ili kompenzatori koji sadrže više stupnjeva. Nedavno su razvijeni jednostupanjski i dvostupanjski širokopojasni kompenzatori bez množila s visokim stupnjem kompenzacije. Uobičajeno se takvi kompenzatori projektiraju da imaju jedinično pojačanje. Ovo svojstvo se obično postiže tako da se unaprijed definira središnji koeficijent kompenzatora. Međutim, bolja kompenzacija i jednostavnija struktura postižu se korištenjem slobodnog središnjeg koeficijenta.

U obradi širokopojasnih signala, CIC filtar često ne može osigurati dovoljno velika gušenja u područjima preklapanja spektra. Za poboljšanje amplitude CIC filtra u područjima preklapanja spektra razvijene su razne strukture. Jedna od učinkovitih struktura proizlazi iz polinomnog izoštravanja amplitude. Ova struktura implementira takozvani izoštrani CIC (*Sharpened CIC*, SCIC) filtar.

U literaturi se razmatraju dva pristupa dizajnu SCIC filtara. Prvi pristup istovremeno izoštrava područje propuštanja i područja preklapanja spektra, dok drugi uzima u obzir samo područja preklapanja spektra. Dizajn izoštranih CIC filtara temelji se na određivanju koeficijenata polinoma koji osiguravaju željenu amplitudnu karakteristiku. Razvijeno je nekoliko metoda koje rezultiraju realnim i cjelobrojnim koeficijentima te koeficijentima izraženim sumama potencija broja 2 (*Sum of Power of Two*, SPT). Posljednji se preferiraju budući da rezultiraju strukturama koje ne sadrže množila.

Najpoznatiju metodu izoštravanja amplitudne karakteristike razvili su Kaiser i Hamming. Oni su predložili polinom za promjenu amplitude, koji je dobiven forsiranjem glatkoće u točkama (0,0) i (1,1). Ovako dobiven polinom ima cjelobrojne koeficijente koji se dobivaju analitičkim izrazima. Nedavno je pokazano da se CIC filtar visokog reda može dobiti Kaiser-Hammingovim izoštravanjem u područjima preklapanja spektra primijenjenim na CIC filtar prvog reda. U tom smislu, CIC filtar višeg reda je zapravo maksimalno glatko izoštrani CIC filtar prvog reda. Nedavno su predložene metode za dizajn SCIC filtara koje koriste kriterij najmanje otežane kvadratne pogreške i minimax kriterij. Ove metode daju SCIC filtre s malim odstupanjima u području propuštanja i dosta velikim gušenjima u područjima preklapanja spektra. Međutim, dobiveni koeficijenti poprimaju realne vrijednosti, što zahtijeva strukturu koja koristi množila.

Nedavno je predloženo izoštravanje CIC filtra u područjima preklapanja spektra primjenom Chebyshevlevih polinoma. Dobiveni Chebyshevlevi SCIC filtri ne sadrže množila samo za određene granične frekvencije područja propuštanja. Ovakvi SCIC filtri rezultiraju s vrlo velikim gušenjem u području preklapanja spektra. Međutim, ovakvo gušenje plaćeno je velikim odstupanjem amplitude od konstantne vrijednosti u području propuštanja.

U okviru rada, razmatrani su decimacijski filtri bez upotrebe množila temeljeni na kompenzaciji i izoštravanju amplitude CIC filtra. Prvo poglavlje disertacije opisuje programski definirani prijamnik s aspekta digitalne obrade signala. Uloga CIC decimacijskog filtra je pokazana na primjeru prijammika s uzorkovanjem u osnovnom frekvencijskom području. Također je dan opći pregled modifikacija CIC filtra koje omogućavaju poboljšanja decimacijskih karakteristika filtra.

Drugo poglavlje opisuje CIC filter uključujući prienosnu funkciju, rekurzivnu i nerekurzivnu realizaciju te amplitudnu karakteristiku. Poseban naglasak je stavljen na nedostatke amplitudnog odziva CIC filtra višeg reda razmatrajući maksimalno odstupanje amplitudnog odziva filtra od konstantne vrijednosti u području propuštanja i minimalnu atenuaciju u područjima preklapanja spektra. Također je dan pregled literature koja opisuje modifikacije CIC filtra za poboljšavanje amplitudne karakteristike u oba područja.

Treće poglavlje opisuje modifikaciju amplitudne karakteristike CIC filtra temeljnu na kompenzaciji u području propuštanja korištenjem simetričnog FIR filtra spojenog u kaskadu s CIC filtrom. Dan je pregled uobičajenih kompenzatora s naglaskom na filtre bez množila uključujući filtre temeljena na: oblikovanju amplitudnog odziva sinusnom funkcijom, maksimalno glatkoj aproksimaciji, minimax aproksimaciji, minimalnoj fazi i višestupanjskim realizacijama. Dizajn CIC kompenzatora obično se temelji na minimizaciji maksimalne apsolutne pogreške u području propuštanja. Međutim, u dizajnu kompenzatora bez množila prikladnija je pogreška koja opisuje razliku između maksimalne i minimalne amplitude. Kako bi se smanjio pad amplitudne karakteristike CIC filtra predložene su dvije metode za dizajn temeljene na minimizaciji maksimalnog odstupanja u području propuštanja. Razmatrani su kompenzatori s jediničnim i nejediničnim pojačanjem. Koeficijenti kompenzatora s jediničnim pojačanjem izraženi kao sume potencija broja 2, dok su koeficijenti kompenzatora s nejediničnim pojačanjem izraženi kao predznačene potencije broja 2. Optimalni koeficijenti su dobiveni globalnim optimizacijskim postupcima temeljenim na intervalnoj analizi i iscrpnom pretraživanju. Također, opisana je prednost predloženih CIC kompenzatora u odnosu na uobičajene kompenzatore.

Četvrto poglavlje opisuje modifikaciju amplitudne karakteristike CIC filtra temeljenu na polinomnom izoštravanju koje implementira izoštrenom CIC (SCIC) filter. Opisana je amplitudna karakteristika, prienosna funkcija i struktura SCIC filtra. Kako bi se postiglo veliko gušenja aliasa, razmatrani su filtri s izoštrenom područjima preklapanja spektra. Dan je pregled uobičajenih izoštrenih filtra koji ne koriste množila u realizaciji uključujući filtre temeljene na maksimalnoj glatkoj aproksimaciji i nedavno predložene filtre temeljene na Chebyshevljevim polinomima. Iako Chebyshevljevi SCIC filtri omogućavaju jako velika gušenja aliasa, ne sadrže množila samo za određene granične frekvencije područja propuštanja. Velika gušenja aliasa za proizvoljno frekvencijsko područje postignuto je dizajnom izoštrenih CIC filtara bez množila temeljenom na minimax aproksimaciji u području preklapanja spektra. Koeficijenti polinoma izoštravanje su izraženi kao suma potencija broja 2. Dizajn je formuliran kao optimizacijski problem. Optimalni koeficijenti filtra dobiveni su

korištenjem globalne optimizacijske tehnike temeljene na intervalnoj analizi. Pokazano je da dobiveni izoštreni filtri postižu jako velika gušenja u područjima preklapanja spektra bez korištenja množila. Također, opisana je prednosti predloženog filtra u odnosu na Chebyshevljevi izoštreni CIC filter.

Peto poglavlje opisuje izoštrene CIC filtre koji u svojoj strukturi sadrže kompenzacijski filter, uključujući izoštrene kompenzirane CIC filtre i kompenzirane izoštrene CIC filtre. Minimax i Chebyshevljevi izoštreni CIC filtri imaju vrlo visok gušenja u području preklapanja spektra. Međutim, takvo ponašanje je plaćeno velikim padom amplitudne karakteristike u području propuštanja. Stoga je predložena jednostavna metoda za dizajn kompenzatora za izoštrene CIC filtre temeljena na maksimalnoj glatkoj aproksimaciji. Za izoštrene filtre s cjelobrojnim ili SPT polinomnim koeficijentima čiji su decimacijski faktori potencije broja 2, predloženi kompenzatori se realiziraju bez upotrebe množila. Da bi se dobila učinkovitija kompenzacija u širem frekvencijskom pojasu i jednostavnije strukture bez množila nego u slučaju maksimalno glatke kompenzacije, predložen je dizajn SCIC kompenzatora s koeficijentima izraženim sumama potencija broja 2, temeljen na minimizaciji maksimalnog odstupanja amplitude u području propuštanja. Složenost kompenzatora određena je zadavanjem ukupnog broja zbrajala u strukturi. Pokazano je da kompenzatori za izoštrene CIC filtre značajno poboljšavaju amplitudnu karakteristiku filtra koristeći jednostavne strukture bez množila.

U okviru rada razvijene su nove metode za dizajn decimacijskih filtera bez upotrebe množila koje osiguravaju vrlo velika gušenja u područjima preklapanja spektra, nisko odstupanje od konstante u području propuštanja te jednostavne strukture. Razmatrane su tri decimacijske strukture bez množila temeljenih na polinomnom izoštravanju i kompenzaciji amplitude: kompenzirani CIC filtri, izoštreni CIC filtri te kompenzirani izoštreni CIC filtri.

Razvijene su dvije metode za dizajn CIC kompenzatora bez množila temeljene na minimizaciji maksimalnog odstupanja u području propuštanja razmatrajući kompenzatore s jediničnim i nejediničnim pojačanjem. Pokazano je da kompenzatori s jediničnim pojačanjem učinkovito poboljšavaju usko područje propuštanja koristeći FIR strukture s tri koeficijenta i do 5 zbrajala. Također je pokazano da predloženi kompenzatori s nejediničnim pojačanjem poboljšavaju široko područje propuštanja koristeći jednostavne FIR strukture s pet koeficijenata i samo 4 zbrajala.

Vrlo male pogreške uslijed preklapanja spektara u obradi široko pojasnih signala postignuto je dizajnom izoštranih CIC filtera bez množila temeljenog na minimax aproksimaciji. Pokazano je da predloženi filtri postižu slično ponašanje kao Chebyshevljevi

izoštreni filtri, ali rezultiraju realizacijom bez množila za proizvoljne specifikacije što nije slučaj kod Chebyshevjevih filtra.

Za poboljšanje područja propuštanja izoštrenih CIC filtara, razvijene su dvije metode za dizajn SCIC kompenzatora bez množila. Prva metoda temeljena je na maksimalnoj glatkoj aproksimaciji. Pokazano je da predloženi kompenzatori poboljšavaju usko područje propuštanja koristeći FIR strukture s tri koeficijenta i do 10 zbrajala. S druge strane, za kompenzaciju SCIC filtera u širokom području propuštanja, razvijena je metoda za dizajn SCIC kompenzatora s ograničenim ukupnim brojem zbrajala temeljena na minimizaciji maksimalnog odstupanja u području propuštanja. Pokazano je da predloženi filtri značajno poboljšavaju široko područje propuštanja koristeći samo do 8 zbrajala.

Ključne riječi: kaskada integratorskih i češljastih sekcija, kompenzacija, decimacija, filter sa konačnim impulsnim odzivom, maksimalno glatka aproksimacija, minimax aproksimacija, strukture bez množila, izoštravanje, predznačene potencije broja dva, suma potencija broja dva

TABLE OF CONTENTS

1. INTRODUCTION.....	1
2. CASCADED-INTEGRATOR-COMB FILTER.....	4
2.1 Transfer function	4
2.2 Multiplierless realization	7
2.3 Measures for CIC response.....	8
2.4 Modifications of CIC filter	10
3. MULTIPLIERLESS COMPENSATORS FOR CIC FILTERS	12
3.1 Ideal compensator	12
3.2 FIR compensators	13
3.2.1 Selective compensators	13
3.2.2 Low-order compensators	14
3.2.3 Multiplierless compensators	15
3.3 Common methods for design of multiplierless compensators.....	18
3.3.1 Sine-based compensators	18
3.3.2 Maximally flat compensators.....	21
3.3.3 Minimax compensators with five coefficients.....	27
3.3.4 Minimum phase compensators.....	28
3.3.5 Multi-stage compensators	30
3.4 CIC compensators with minimum passband deviation	34
3.4.1 Compensators with unity gain	34
3.4.2 Compensators with non-unity gain	44
4. SHARPENED CASCADED-INTEGRATOR-COMB FILTERS	51
4.1 Polynomial sharpening	51
4.2 Transfer function	52
4.3 Structure of sharpened CIC filter.....	55
4.4 Sharpening polynomials	55
4.4.1 Maximally flat sharpening	57
4.4.2 Chebyshev sharpening	59
4.5 Minimax sharpened CIC filter.....	61
4.5.1 Objective function.....	61

4.5.2	Adder cost	64
4.5.3	Design examples	64
4.5.4	Passband droop	67
5.	COMPENSATORS FOR SHARPENED CIC FILTERS	69
5.1	Sharpening of compensated CIC filter	69
5.2	Compensation of sharpened CIC filter	72
5.2.1	Narrowband compensators for sharpened CIC filters.....	72
5.2.2	Wideband compensators for sharpened CIC filters	81
6.	CONCLUSION	90
7.	REFERENCES.....	91
	Curriculum Vitae	97
	Životopis.....	99

1. INTRODUCTION

During last two decades, software radio technology has penetrated in all parts of wireless communications. It is a consequence of the ability of software radio receivers (SRRs) to cover various standards using the same hardware [1]. SRRs are based on digital signal processing (DSP) algorithms. These algorithms are usually implemented on digital signal processors. However, their use is limited to lower frequencies. Therefore, application specific integrated circuits are often used for processing the signals near the receiver's front end. However, development of field-programmable-gate-array (FPGA) devices has enabled their use at some intermediate frequencies as well.

In [1], the architecture of the canonical software radio receiver is considered. It contains antenna, RF preprocessing, and a single chip with analog to digital and digital to analog conversion and digital signal processing. Unfortunately, due to limitations of the components available at the present state of technology, a real-world software radio receiver is more complex [2]. The block diagram of a digital receiver is shown in Figure 1.1. The signal from the antenna is first filtered by a low-pass filter to remove the components outside the Nyquist band. The signal obtained is attenuated by a programmable attenuator and amplified by a fixed-gain amplifier to ensure the appropriate level at the input of the analog to digital converter (ADC). The signal from ADC is further processed by a digital receiver. It performs mixing, channel filtering, automatic gain control, demodulation, and other functions required to obtain demodulated signal.

The signal from ADC is fed to mixers together with the signals from numerically controlled oscillator (NCO). After the mixers, the signals are fed to cascaded-integrator-comb (CIC) decimators which are used to reduce the sampling rate. The decimators are realized using Hogenauer's method [3]. CIC decimators are computationally-efficient narrowband-lowpass filters supporting high sample-rate conversion factors. High decimation factor used in the decimator stage gives certain amount of freedom in the design of channel filters. However, CIC filter introduces a high passband droop which can be reduced by connecting a linear-phase finite-impulse-response (FIR) filter called CIC compensator in cascade with the CIC decimator. The compensated signal is then fed to the channel filters. The signal within the desired channel is further processed by automatic gain control (AGC), which is used to adjust the signal to keep its level within some desired range. Finally, depending on the

modulation scheme, the demodulator (DEM) will process the complex signal taken after the AGC circuit.

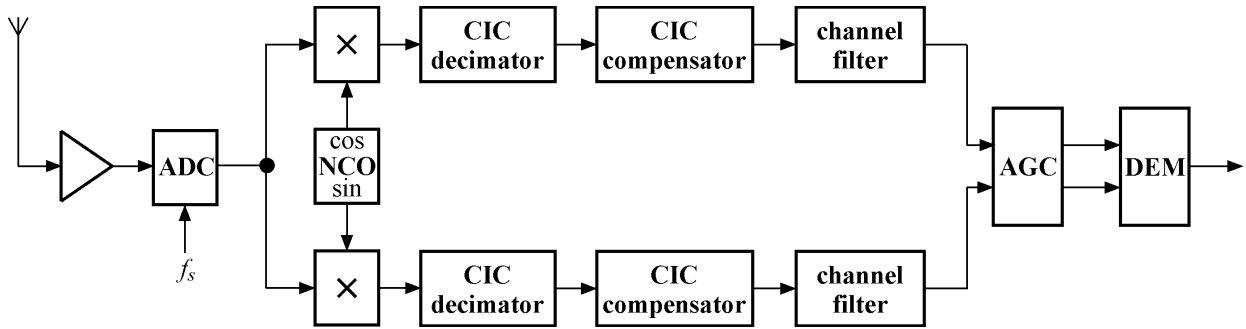

Figure 1.1 Block diagram of digital receiver.

Decimation filters are unavoidable part of digital receivers. During decades, various design methods and structures for the decimation filters have been developed. The decimator design makes a tradeoff among complexity, efficiency, power consumption, and delay. Recent development of these filters considers multiplierless structures with high decimation capabilities.

The doctoral thesis presents the methods for the design of decimation filters having very high folding-band attenuations and low deviations from constant in the passband, as well as the filter structures which do not contain general-purpose multipliers. These methods and structures arise from improving the amplitude response of the CIC filter.

The CIC filter is the simplest multiplierless decimation filter. Since it is multiplierless, a CIC compensator with multiplierless structure is preferable as well. During the last two decades, various methods for the design of multiplierless CIC compensators have been developed. Commonly, these methods consider low-order transfer functions with the coefficients expressed as sums of powers of two. To obtain the compensator's coefficients, most of the methods employ classical error functions and optimization techniques. This doctoral thesis presents new methods for improving the existing compensation techniques by applying new error functions and global optimization procedures.

In processing of wideband signals, the CIC filter is often incapable of meeting the requirement for high folding-band attenuations. To improve the CIC-filter folding-band response, various structures have been developed. An efficient structure arises from the polynomial sharpening of the folding-band response. This structure implements so-called sharpened CIC filter. The thesis presents the sharpened CIC filters with very high folding-

band attenuations obtained by applying the polynomial sharpening within the folding bands only. In addition, since the original CIC filters are multiplierless, sharpened CIC filters with multiplierless structures are also preferable. To obtain such structures, the sharpening polynomials whose coefficients are expressed as sums of powers of two are considered.

Polynomial sharpening of the CIC filter within the folding bands introduces a high passband droop. This thesis proposes the passband improvement accomplished by connecting the compensator in cascade with the sharpened CIC filter. The compensation is performed by using low-order transfer functions. Furthermore, for multiplierless sharpened CIC filters, the thesis considers multiplierless transfer functions for the compensation. The multiplierless compensation makes a trade-off between compensator's complexity and capability. Therefore, narrowband and wideband compensators are considered separately. The thesis describes how to obtain compensators' transfer functions by using classical and new approximation techniques, which include the coefficients expressed as sums of powers of two.

The thesis is organized as follows. The second chapter describes the transfer function and multiplierless structure of the CIC filter. The third chapter describes common and proposed methods for the design of multiplierless CIC compensators. In the fourth chapter, common transfer functions and multiplierless realizations of sharpened CIC filter are described. The fifth chapter presents the compensation of the sharpened CIC filters together with the methods for the design of multiplierless compensators suitable for narrowband and wideband sharpened CIC filters.

2. CASCADED-INTEGRATOR-COMB FILTER

2.1 Transfer function

Cascaded-integrator-comb (CIC) filter [3] is a symmetric finite-impulse-response (FIR) filter. It is often used in multi-rate signal-processing applications requiring high sample rate conversion factors. The impulse response of the CIC filter is given by

$$h_{CIC}[n] = \frac{1}{R} \sum_{k=0}^{R-1} \delta[n-k] \quad (2.1)$$

where R is the sample rate conversion factor. The corresponding transfer function is given by

$$H_{CIC}(z) = \frac{1}{R} \sum_{k=0}^{R-1} z^{-k} \quad (2.2)$$

It is clear that $H_{CIC}(z)$ is a geometric series. By applying the formula for the sum of the first R terms of geometric series, transfer function in (2.2) can be rewritten in a *recursive form* as in [3]

$$H_{CIC}(z) = \frac{1}{R} \frac{1-z^{-R}}{1-z^{-1}} \quad (2.3)$$

The amplitude response of the CIC filter is given by

$$H_{CIC}(\omega) = \frac{1}{R} \frac{\sin\left(\frac{\omega R}{2}\right)}{\sin\left(\frac{\omega}{2}\right)} \quad (2.4)$$

If the CIC filter is employed as a decimation filter, its amplitude response represents the antialiasing filter. However, the response in (2.4) is usually incapable of providing high folding-band attenuations. For such requirements, the cascade of CIC filters is rather used. The cascade of N filters is called the CIC filter of N th order. Its transfer function is thus given by

$$H_{CIC}(z) = \left(\frac{1}{R} \frac{1-z^{-R}}{1-z^{-1}} \right)^N \quad (2.5)$$

The corresponding amplitude response has the form

$$H_{CIC}(\omega) = \left[\frac{1}{R} \frac{\sin\left(\frac{\omega R}{2}\right)}{\sin\left(\frac{\omega}{2}\right)} \right]^N \quad (2.6)$$

The impulse response of the N th-order CIC filter is obtained by multiple autoconvolutions of the response in (2.1). Since the response in (2.1) is all positive function, the cascade response is also all positive function. It is given by [3]

$$h_{CIC}[n] = \frac{1}{R^N} \sum_{l=0}^{\lfloor n/R \rfloor} (-1)^l \binom{N}{l} \binom{N-1+n-Rl}{n-Rl}; \quad n = 0, \dots, (R-1)N \quad (2.7)$$

A simple calculation of the impulse response coefficients can be found in [4]. Figure 2.1 shows the impulse responses of the CIC filters with $N = 1, 2, 3$ and $R = 10$. The corresponding amplitude responses are shown in Figure 2.2. The folding-band responses are placed within the dashed lines, assuming passband edge frequency is $\omega_p = \pi/4/R$. It is clear from the figure that the folding-band attenuation is significantly improved by an increase in the filter order.

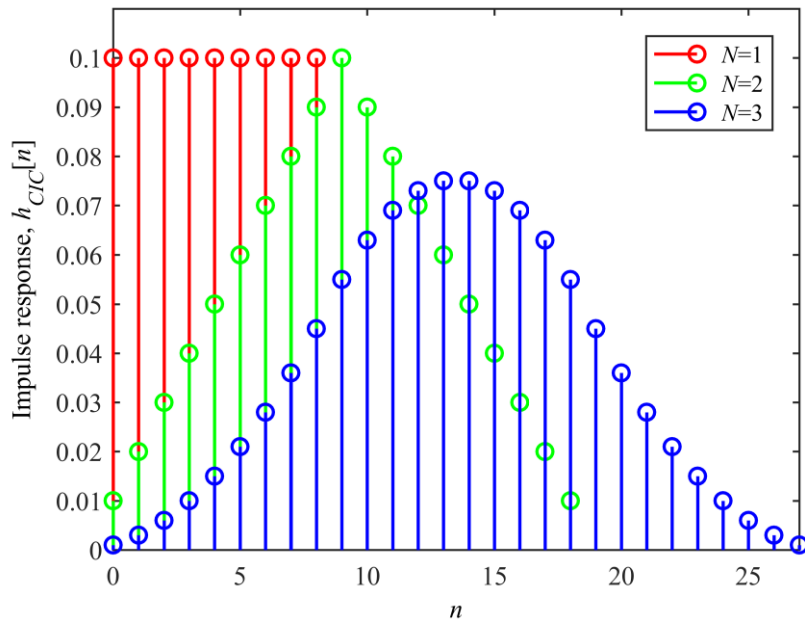

Figure 2.1 Impulse responses of CIC filters with $N = 1, 2, 3$ and $R = 10$.

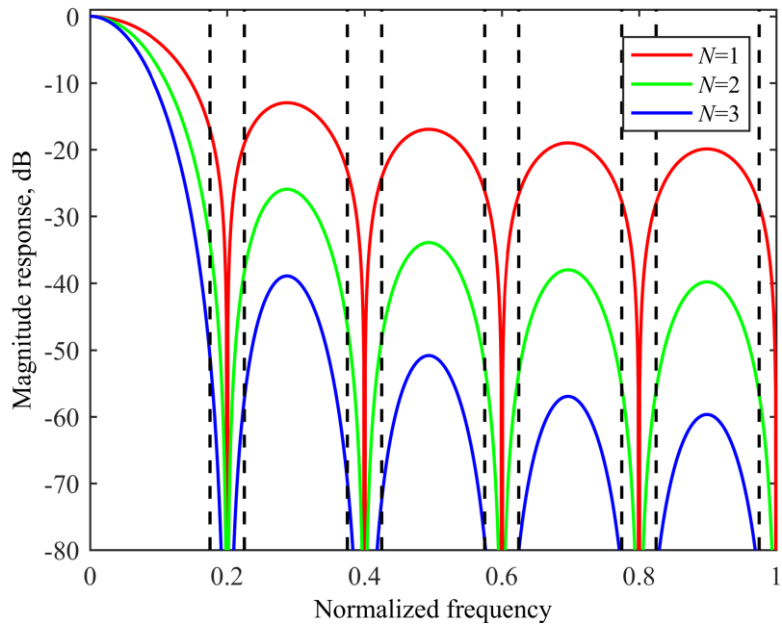

Figure 2.2 Magnitude responses of CIC filter with $N = 1, 2, 3$ and $R = 10$. Folding-band edges are plotted in dashed lines. Passband edge frequency is $\omega_p = \pi/4/R$.

2.2 Multiplierless realization

The decimation filter in (2.5) can be realized as a *recursive FIR filter* which is composed of N integrators and N combs connected in the cascade. Figure 2.3 shows the structure of an N th-order CIC filter operating at the high sampling rate.

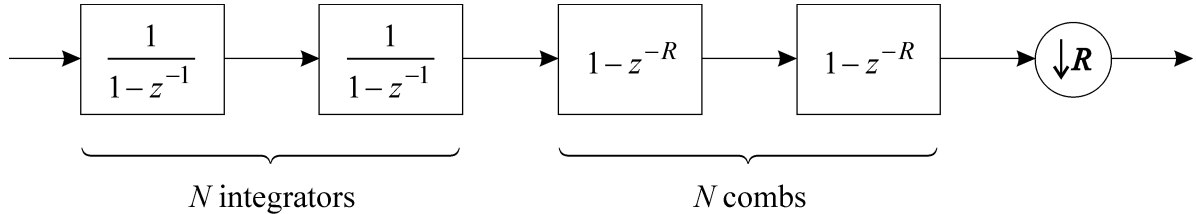

Figure 2.3 Realization of N th-order CIC decimation filters operating at high sampling rate.

By using the *noble identity*, the combs can be placed after the downsampler [3]. The structure obtained is shown in Figure 2.4. It is clear that the cascaded-integrator-comb filter has a multiplierless structure. Furthermore, it employs only two building blocks and it does not need additional storage for the filter coefficients.

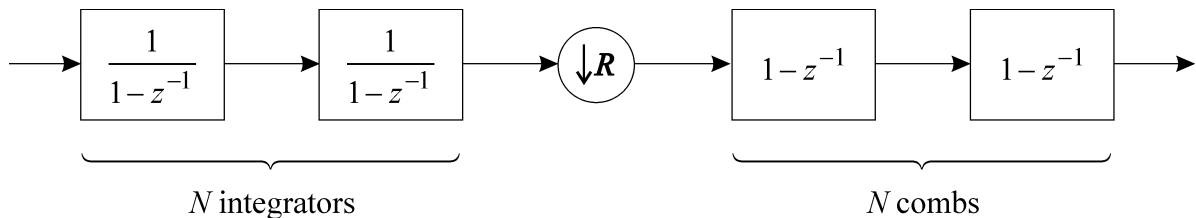

Figure 2.4 Realization of N th-order CIC decimation with comb filters operating at low sampling rate [3].

For decimation factors expressed as $R = 2^m$, the transfer function of the CIC filter can be factorized as

$$H_{CIC}(z) = \left[\frac{1}{2^m} \sum_{k=0}^{2^m-1} z^{-k} \right]^N = \frac{1}{2^{mN}} \prod_{k=0}^{m-1} (1 + z^{-2^k})^N \quad (2.8)$$

Such a decimation filter can be realized as the cascade of m identical *non-recursive FIR* filters, each followed by the downsampler with factor two. Figure 2.5 shows the non-recursive structure.

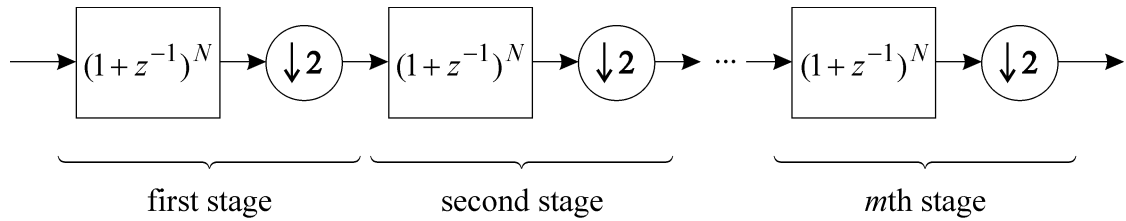

Figure 2.5 Non-recursive realization of CIC filter whose decimation factor is expressed as power of two.

The non-recursive realizations can also be obtained for the decimation factors expressed as a power of three [5] or for the factors taking an arbitrary integer value [6]. The summary of non-recursive realizations can be found in [7]. However, these structures are often considered as complex [8].

2.3 Measures for CIC response

The amplitude response of the CIC filter, given in (2.6), has monotonically decreasing passband response. Consequently, the CIC filter introduces the *passband droop* which is often intolerable in many digital-signal-processing applications. To improve the passband, various compensation techniques have been proposed. Some of these techniques will be discussed in the third chapter.

The second measure of the CIC response is the *minimum folding-band attenuation*. This attenuation is achieved at the lower edge of the first folding-band. Figure 2.6 and Figure 2.7 show the passband droops and the minimum folding-band attenuations of the CIC filters with $1 \leq N \leq 8$ and $R = 10$. The droop and attenuations are measured for the passband edge frequencies $\omega_p = \pi/4/R$, $\omega_p = \pi/3/R$, and $\omega_p = \pi/2/R$. It is clear from the figures that high folding-band attenuations are paid with high passband droops. For example, the eight-order CIC filter bringing the minimum folding-band attenuation of 80 dB introduces the passband droop of 7 dB, assuming $\omega_p = \pi/2/R$.

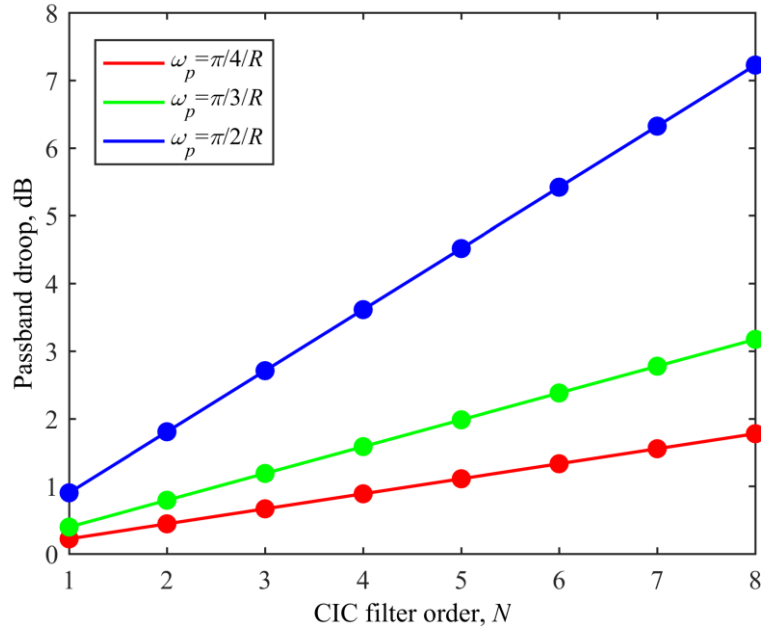

Figure 2.6 Passband droops of CIC filters with $1 \leq N \leq 8$ and $R = 10$, obtained for various passband edge frequencies ω_p .

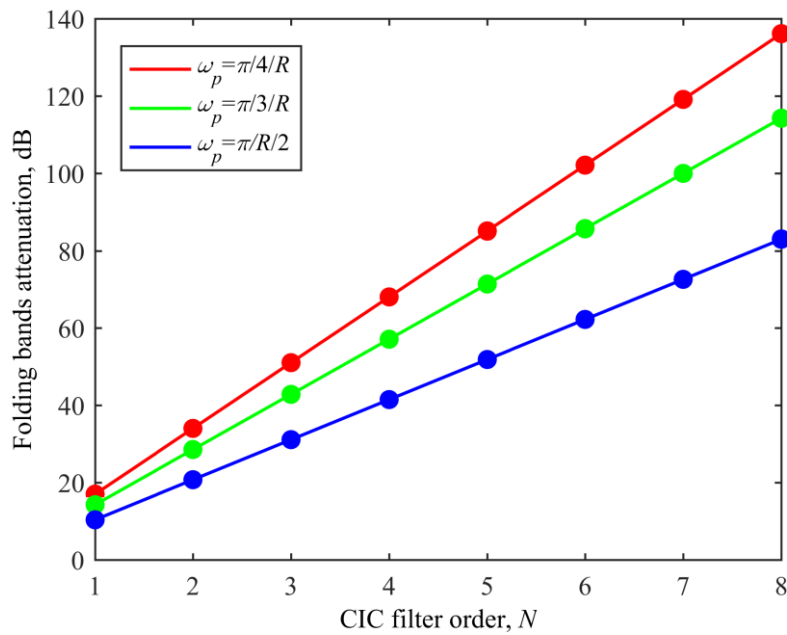

Figure 2.7 Minimum folding-band attenuations of CIC filters with $1 \leq N \leq 8$ and $R = 10$, obtained for various passband edge frequencies ω_p .

2.4 Modifications of CIC filter

To improve the amplitude response, various modifications of the CIC filter have been developed [9]–[23]. In [9]–[11], the CIC filter is decomposed in several recursive stages implementing so-called *multi-stage CIC filters*. This approach brings higher folding-band attenuations. In [10], the multi-stage CIC filter is realized using a non-recursive structure. In [12], the folding-band response is improved by using a *cosine filter*. This approach is further improved in [13] and [14]. However, the cosine filters usually operate at high sampling rates only. In [15], the third-order *modified CIC* (MFC) filter based on the rotation of the CIC filter's transfer function zeros has been described. Later, a generalization of this approach resulting in the *generalized comb filters* (GCF) has been presented in [16], [17]. In general, the GCF filters have the real-valued coefficients. However, a quantization of the GCF coefficients bringing multiplierless realization is used in [18]. Finally, in [19], the decimation structure obtained by a hybrid between the CIC and GCF filter has been proposed.

Recently, a closed-form design of selective multiplierless FIR filters based on the CIC transfer functions has been proposed [20]–[23]. In [23], the amplitude response of the CIC-based filter is given by

$$H_{CIC-based}(\omega) = H_{CIC}(\omega, R)^{S+1} [H_{CIC}(\omega, R-3)H_{CIC}(\omega, R-2)H_{CIC}(\omega, R-1)]^S \times [H_{CIC}(\omega, R+1)H_{CIC}(\omega, R+2)H_{CIC}(\omega, R-3)]^S \quad (2.9)$$

where $H_{CIC}(\omega, R + \alpha)$ is the amplitude response of the first-order CIC filter with the decimation factor $R + \alpha$, and S is the parameter taking an integer value. As an example, the CIC-based filter with the lowest complexity ($S = 1$) is compared to the original CIC filter with $N = 8$. Both filters use eight integrators and eight comb filters in recursive realization. Figure 2.8 shows the magnitude responses of these filters, assuming $R = 10$. It is clear that the CIC-based filter provides higher folding-band attenuation than the original CIC filter. However, it requires a more complex structure.

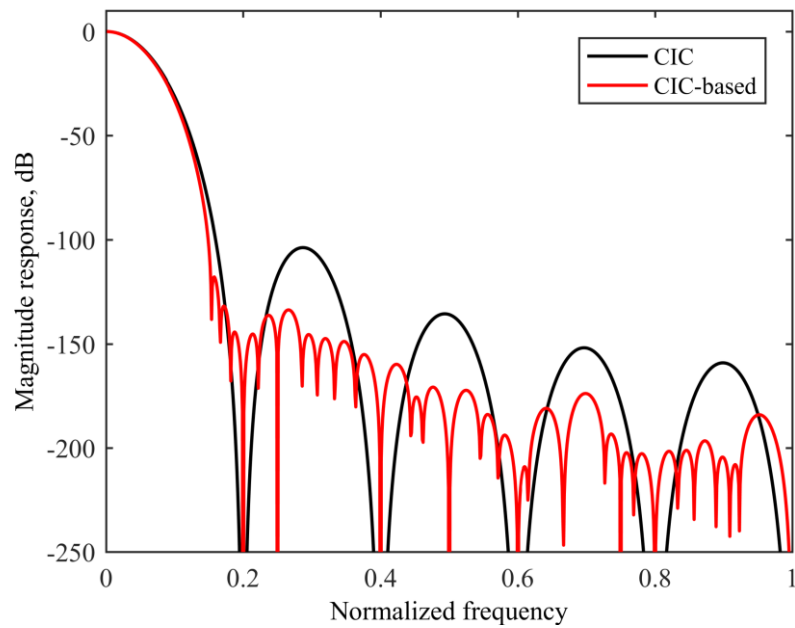

Figure 2.8 Magnitude responses of CIC [3] and CIC-based filter [23].

Other CIC-based FIR decimation filters have been proposed in [24]–[26]. In [24], the design of multiplierless decimation filters by using the *cyclotomic polynomials* is introduced, and further improved in [25]. In [26], very sharp decimators obtained by using *frequency-response masking* (FRM) technique have been proposed.

3. MULTIPLIERLESS COMPENSATORS FOR CIC FILTERS

3.1 Ideal compensator

High-order CIC filters introduce a high passband droop which is intolerable in many applications, such as in multi-standard receivers [27]–[29]. The most popular technique for reducing the droop is connecting an FIR filter called compensator in cascade with CIC filter. If a CIC filter is used as decimator, the compensator is connected at its output. Consequently, it compensates the CIC response relative to the low sampling rate. This response is given by

$$H_C(\omega) = H_{CIC}\left(\frac{\omega}{R}\right) = \left[\frac{1}{R} \frac{\sin\left(\frac{\omega}{2}\right)}{\sin\left(\frac{\omega}{2R}\right)} \right]^N \quad (3.1)$$

The ideal compensator has the amplitude response

$$H_{\text{ideal}}(\omega) = \frac{1}{H_C(\omega)} \quad (3.2)$$

The ideal response can only be approximated. Since the CIC filter is a linear-phase system, the compensator with a linear-phase transfer function is preferable as well. The amplitude response of the FIR compensator with L coefficients is given by

$$H(\omega, \mathbf{c}) = \begin{cases} c_0 + 2 \sum_{k=1}^{(L-1)/2} c_k \cos(k\omega) & ; \text{ for odd } L \\ 2 \sum_{k=1}^{L/2} c_k \cos\left[\left(k - \frac{1}{2}\right)\omega\right] & ; \text{ for even } L \end{cases} \quad (3.3)$$

where \mathbf{c} is the vector of coefficients.

3.2 FIR compensators

3.2.1 Selective compensators

CIC filters are originally developed to support high sample rate conversion factors. For high R , the CIC response in (3.1) can be approximated as

$$H_C(\omega) \approx \left[\frac{\sin\left(\frac{\omega}{2}\right)}{\frac{\omega}{2}} \right]^N \quad (3.4)$$

It is clear that the response in (3.4) corresponds to the N th power of sinc function. Consequently, the compensator approximates the inverse of the N th power of sinc function. Such an approach originated from the early phase of compensator design. During this phase, the selectivity was often incorporated into the compensator response. To achieve selectivity, high-order FIR transfer functions were used. In their design, the *Parks-McClellan design* [30] was usually employed. Many signal processing toolboxes, such as MATLAB, support the equiripple design of the selective inverse-sinc compensators [31].

Figure 3.1 shows the high-rate magnitude response of the CIC filter with $N = 5$ and $R = 1024$ together with the response of the equiripple compensator with 51 coefficients, obtained for $\omega_p = \pi/4/R$ and 40 dB folding-band attenuation.

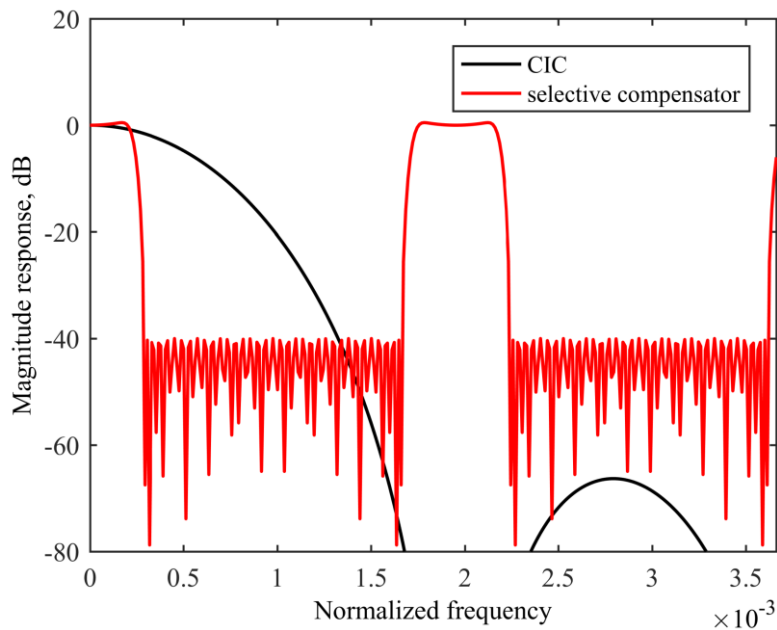

Figure 3.1 Magnitude responses of CIC filter with $N = 5$ and $R = 1024$ and selective FIR compensator with 51 coefficients, assuming $\omega_p = \pi/4/R$.

3.2.2 Low-order compensators

If the requirement for selectivity is excluded, the design of compensators deals with the passband only. In the minimax design, the error function is defined as the maximum passband deviation of the compensated response. It is thus given by

$$\varepsilon(\mathbf{c}) = \max_{0 \leq \omega \leq \omega_p} |H_C(\omega)H(\omega, \mathbf{c}) - 1| \quad (3.5)$$

where ω_p is the passband edge frequency at the low rate, taking a value from the interval $0 \leq \omega_p \leq \pi$. The error in (3.5) can be written as

$$\varepsilon(\mathbf{c}) = \max_{0 \leq \omega \leq \omega_p} \left| H_C(\omega) \left[H(\omega, \mathbf{c}) - \frac{1}{H_C(\omega)} \right] \right| \quad (3.6)$$

It is clear that the function in (3.6) represents a weighted maximum deviation, where the ideal response in (3.2) is considered as the desired response and the CIC low-rate response corresponds to the weighting function. By using the error in (3.6), the optimum minimax compensators are obtained by solving the problem

$$\hat{\mathbf{c}} = \arg \min_{\mathbf{c}} \varepsilon(\mathbf{c}) \quad (3.7)$$

It is clear that the problem in (3.6) and (3.7) corresponds to the *weighted minimax design* of FIR filters. Therefore, the optimum compensator coefficients can be found by the Parks-McClellan algorithm [30]. Consequently, the optimum coefficients take real values.

The minimax design is illustrated with an example considering the CIC filter with $N = 5$ and $R = 32$, assuming the passband edge frequency is $\omega_p = \pi/3$. Figure 3.2 shows the magnitude responses of the ideal compensator and FIR compensators having five and six coefficients. It is clear that the FIR compensators with a low number of coefficients efficiently approximate the ideal response within the passband. However, compensator with five coefficients approximates the ideal response in a wider band. Such behavior is expected since even-symmetric FIR filter with an even number of coefficients has a transfer function zero at $z = -1$. Consequently, its amplitude response has a steep slope in the vicinity of the frequency $|\omega| = \pi$. Therefore, compensators with an odd number of coefficients are preferred [32].

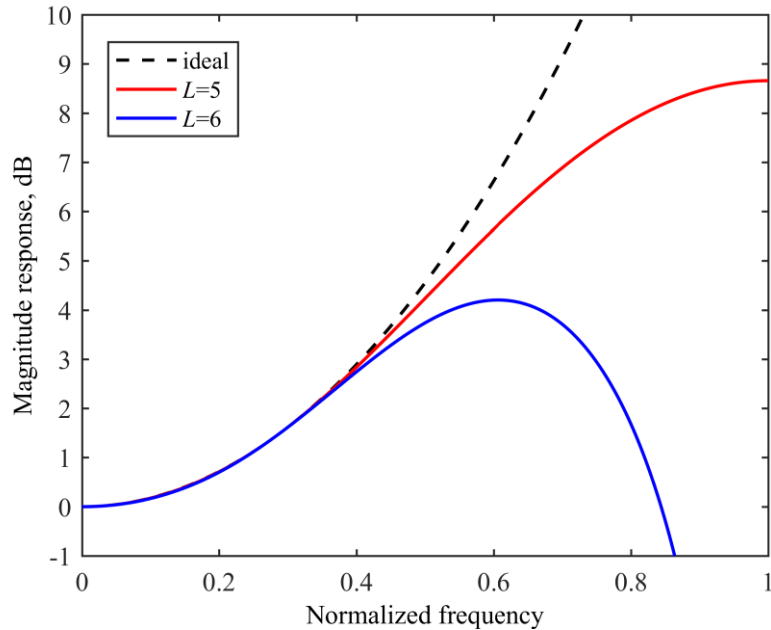

Figure 3.2 Magnitude responses of ideal compensator and FIR compensators with five and six coefficients for CIC filter with $N = 5$ and $R = 32$, assuming $\omega_p = \pi/3$.

In addition to the minimax design, Kim *et al.* [27] proposed a weighted-least-squares (WLS) design of the compensators with three coefficients. Compared to the minimax design, the computational time of WLS is significantly lower. However, for the same number of coefficients, the WLS design yields a higher deviation of the compensated response than does the corresponding minimax design.

3.2.3 Multiplierless compensators

The direct-form structure of a linear-phase CIC compensator with an odd number of coefficients is shown in Figure 3.3. In general, one multiplier is needed for the multiplication of an input sample by each compensator coefficient. This multiplication is realized as a constant multiplier. However, the efficient realization of the constant multiplier can be achieved by using only shifts, adders, and subtractors. Such a realization is known as multiplierless. For example, in MATLAB, the DSP System Toolbox supports the design of multiplierless compensators [33]. However, the multiplierless structures can be further optimized with respect to the complexity. The common measure of the multiplierless filter's complexity is the number of adders or, shortly, adder cost. Since the implementations of adders and subtractors have similar hardware complexity, in the cost measure, subtractors are usually counted as adders.

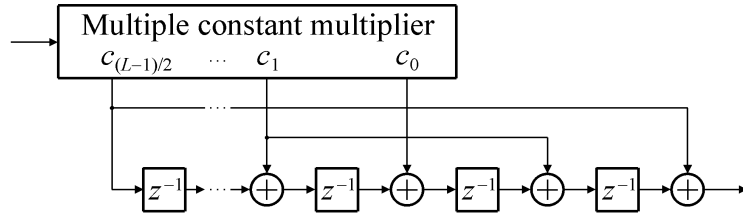

Figure 3.3 Structure of symmetric CIC compensator with odd number of coefficients.

In a multiplierless realization, the constant multipliers are expressed using the *signed-powers-of-two* (SPT) *representation*. The SPT representation of constant multiplier c is given by

$$c = \sum_{i=0}^{W-1} b_i 2^{-i} \quad (3.8)$$

where W is the wordlength and $b_i \in \{-1, 0, 1\}$. Each $b_i \neq 0$ represents one SPT term. This representation is also called *singed digit* (SD) *representation* [34]. In the realization of the constant multipliers, the adder cost is usually calculated as the total number of terms decreased by one. The SPT representation with the minimum number of non-zero terms is called *minimum-signed-digit* (MSD) *representation*. In multiplierless design, a common MSD representation is *canonical-signed-digit* (CSD) where two non-zero terms cannot be adjacent. This representation is obtained by adding the constraint $b_i b_{i+1} = 0$ to (3.8). For example, the CSD representation of $c = 2805$ is $c = 2^{12} - 2^{10} - 2^8 - 2^4 + 2^2 + 2^0$.

Dempster *et al.* [35] proposed an optimum MSD representation of the constant multipliers obtained by the network of shifts and adders represented with the directed graphs described with a set of edges (lines between connections) and vertices (connections). These graphs are called directed acyclic graphs (DAGs). In [36], Gustafson *et al.* presented all possible unique DAGs with adder cost up to five. These graphs are shown in Figure 3.4. Note that the graphs denote the signed-power-of-two multiplication. Graph's edges represent shifts, whereas the graph's vertexes represent adders. In addition, the adder cost in a single vertex is equal to the number of its inputs reduced by one. For example, a graph with adder cost equal to zero represents a shift, that is, multiplication by $c = \pm 2^k$. The graph with the unity cost represents the addition of two differently shifted input values, that is, multiplication by $c = \pm 2^m \pm 2^n$. More complex graphs are formed by additive graphs or by multiplicative graphs. From Figure 3.4, it is clear that some graphs are formed as leapfrog. For illustration, $c = 2805$

is represented with the DAG having adder cost equal to three (see the third graph within the Cost 3 part in Figure 3.4). By using the exhaustive search over the graphs, $c = (2^3 + 2^1 + 2^0)(2^8 - 2^0)$ is found. It is clear that this representation results in the structure needing two adders less than the structure incorporating the CSD representation of c .

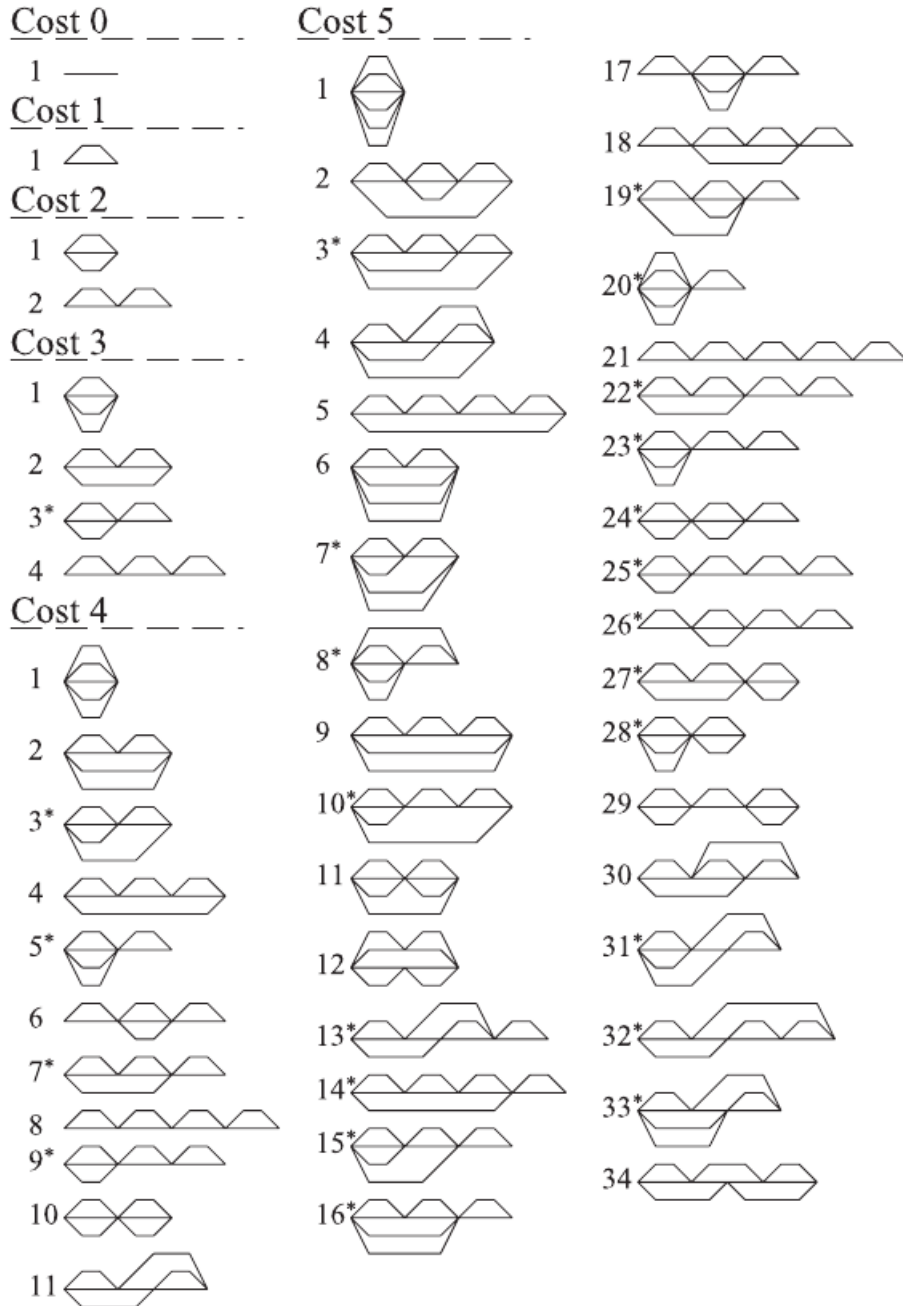

Figure 3.4 Unique directed acyclic graphs having adder cost up to five [36].

3.3 Common methods for design of multiplierless compensators

During the last decade, various methods for the design of multiplierless CIC compensators having simple structures and/or exhibiting high compensation capabilities have been developed. Many of these methods separately consider *narrowband* and *wideband* compensation. The narrowband methods usually deal with $\omega_p \leq \pi/4$, whereas the wideband methods assume $\omega_p > \pi/4$. Furthermore, the CIC compensators can also be applied to improve modified CIC filters, such as multi-stage [10], [11], generalized [18], [37], and cosine-based [12]–[14] CIC filters as well as selective CIC-based filters [23].

It is well known that compensators with two [38] and three [27]–[29], [32], [39]–[42] coefficients significantly improve narrow passbands. Moreover, in such compensation the coefficients need a low number of SPT terms, thus resulting in simple compensator structures. On the other hand, to efficiently improve wideband responses, more complex structures are required. Such compensators are usually realized as single-stage compensators having more than three coefficients [32], [42], [43] or as multi-stage compensators [44]–[46].

In the following sections, common methods for the design of narrowband and wideband multiplierless compensators are described in detail.

3.3.1 Sine-based compensators

3.3.1.1 Narrowband compensators

In [39], Doleček and Mitra proposed the design of compensators based on the estimation of compensator magnitude response with the sine function. The estimation is given by

$$\left|H(e^{j\omega})\right| = \left|1 + 2^{-b} \sin^2(\omega/2)\right| \quad (3.9)$$

where b is the parameter taking an integer value. By substituting $\sin^2(\omega/2) = [1 - \cos(\omega)]/2$ into (3.9), the corresponding transfer function takes the form

$$H(z) = A(1 + Bz^{-1} + z^{-2}) \quad (3.10)$$

where $A = -2^{-(b+2)}$ and $B = -(2^{b+2} + 2)$. The optimum compensators are obtained by the exhaustive search of b over the integer space. For the CIC filters with $2 \leq N \leq 6$ and $R = 16$,

assuming $\omega_p = \pi/8$ (narrowband) and $\omega_p = 3\pi/5$ (wideband), the optimum values of b together with the adder cost are tabulated in Table 3.1.

Table 3.1 Values of parameter b together with adder cost N_A for CIC filters with $2 \leq N \leq 6$ and $R = 16$ [39].

N	$\omega_p = \pi/8$		$\omega_p = 3\pi/5$	
	b	N_A	b	N_A
2	2	3	1	3
3	2	3	0	3
4	1	3	0	3
5	0	3	-1	2
6	0	3	-1	2

Figure 3.5 shows the maximum passband deviations of the original and compensated CIC filters of various orders for $\omega_p = \pi/8$. It is clear that the compensated filters exhibit the deviations less than 0.1 dB by employing three adders.

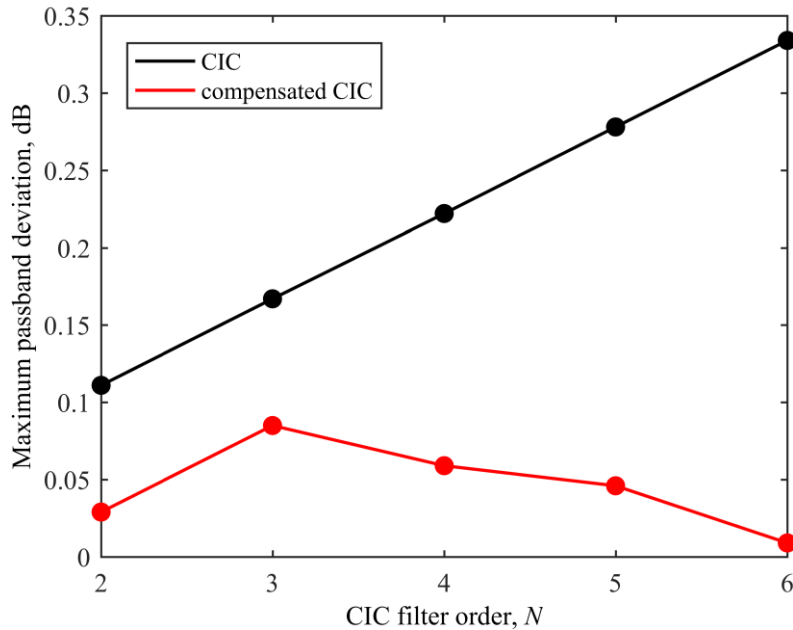

Figure 3.5 Maximum passband deviations of original and compensated CIC filters with $2 \leq N \leq 6$ and $R = 16$, assuming $\omega_p = \pi/8$ [39].

3.3.1.2 Wideband compensators

In [41], Doleček and Vazquez proposed a generalization of the previously described compensators, which includes wideband compensation. In the paper referred to, the

magnitude response of the compensator is obtained by replacing 2^{-b} with B in (3.9), where B takes real values. The response is hence given by

$$\left|H(e^{j\omega})\right| = \left|1 + B \sin^2(\omega/2)\right| \quad (3.11)$$

The corresponding transfer function has the form

$$H(z) = 2^{-2} \left[(-1 + 2z^{-1} - z^{-2})B + 2^2 z^{-1}\right] \quad (3.12)$$

To obtain the compensators providing given maximum passband deviation of the compensated response, δ_p , the authors assume the passband having $\omega_p = \pi/2$. Such a design is described with the optimization problem

$$\begin{aligned} B &= \min_k b_k \\ \text{subject to: } b_k &= \frac{10^{\delta_p/20} [\pi k / (4K)]^N - \sin^N [\pi k / (4K)]}{\sin^N [\pi k / (4K)] \sin^2 [\pi k / (4K)]} ; \quad k = 1, \dots, K \end{aligned} \quad (3.13)$$

where K is the number of uniformly spaced frequency points within the passband. The problem in (3.13) is simple. Therefore, the authors suggested the exhaustive search for its solving. Furthermore, since the optimum values of B are not SPT representable, they recommended the rounding of B to $r = 2^{-2}$. For the CIC filters with $1 \leq N \leq 5$ and $R = 16$, the SPT values of B and the corresponding adder cost for $\delta_p = 0.4$ dB are tabulated in Table 3.2.

Table 3.2 Values of parameter B together with adder cost N_A for the CIC filters with $1 \leq N \leq 5$ and $R = 16$, assuming $\delta_p = 0.4$ dB and $\omega_p = \pi/2$ [41].

N	B	N_A
1	2^{-2}	3
2	2^{-1}	3
3	$2^{-1} + 2^{-2}$	4
4	1	3
5	$1 + 2^{-2}$	4

Figure 3.6 shows the maximum passband deviations of the original and compensated CIC filters of various orders. It is clear that the deviation increases up to 0.4 dB with an increase in the CIC-filter order. Moreover, a significant reduction of the droop is achieved for $N = 4$ by the compensator requiring three adders only.

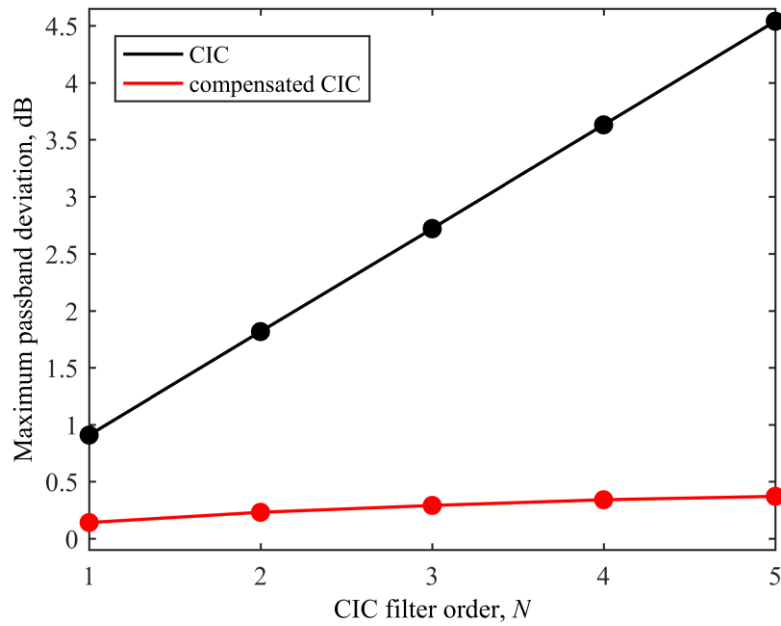

Figure 3.6 Maximum passband deviations of original and compensated CIC filters with $1 \leq N \leq 5$ and $R = 16$, assuming $\omega_p = \pi/2$ [41].

3.3.2 Maximally flat compensators

3.3.2.1 Compensator with arbitrary number of coefficients

In [32], Molnar and Vučić proposed closed-form design of compensators based on a *maximally flat approximation*. To obtain the compensator coefficients, they used the error function

$$E(\omega) = H(\omega) - H_{\text{ideal}}(\omega) \quad (3.14)$$

To satisfy the maximally flat error criterion at $\omega = 0$, first n derivatives of the error function at $\omega = 0$ are set to 0, resulting in

$$H^{(n)}(\omega) \Big|_{\omega=0} = H_{\text{ideal}}^{(n)}(\omega) \Big|_{\omega \rightarrow 0} \quad (3.15)$$

The responses $H(\omega)$ and $H_{\text{ideal}}(\omega)$ are even functions of ω . Therefore, their odd-derivatives at $\omega = 0$ are 0. The even derivatives of $H_{\text{ideal}}(\omega)$ when $\omega \rightarrow 0$ are given by

$$H_{\text{ideal}}^{(n)}(\omega) \Big|_{\omega \rightarrow 0} = \sum_{q=1}^{n/2} (2q-1) \left[\frac{N |B_{n-2q+2}|}{n-2q+2} \left(1 - \frac{1}{R^{n-2q+2}} \right) \right]^q \quad (3.16)$$

where B_{n-2q+2} are even-indexed Bernoulli numbers. In this section, only compensators with odd number of coefficients are considered. Therefore, the even derivatives of $H(\omega)$ at $\omega = 0$ are given by

$$H^{(n)}(\omega)\Big|_{\omega \rightarrow 0} = 2 \sum_{k=1}^{(L-1)/2} (-1)^{n/2} k^n c_k \quad (3.17)$$

Using (3.15)–(3.17), the system of linear equations can be formed. A linear system of equations has unique solution if the number of variables and the number of equations is equal. Therefore, the even-order derivatives of orders from $n = 2$ to $n = L - 1$ are considered. The system is obtained in the form

$$\mathbf{A}\mathbf{c} = \mathbf{b} \quad (3.18)$$

where $\mathbf{c} = [c_1, \dots, c_{(L-1)/2}]^T$. The matrix \mathbf{A} and column vector \mathbf{b} are given by

$$\begin{aligned} \mathbf{A} &= [A_{u,v}], \quad A_{u,v} = 2(-1)^u v^{2u} \\ u &= 1, 2, \dots, (L-1)/2, \quad v = 1, 2, \dots, (L-1)/2 \\ \mathbf{b} &= [b_u], \quad b_u = H_{\text{ideal}}^{(2u)}(\omega)\Big|_{\omega \rightarrow 0}, \quad u = 1, 2, \dots, (L-1)/2 \end{aligned} \quad (3.19)$$

The solution of the system in (3.18) is found as

$$\mathbf{c} = \mathbf{A}^{-1}\mathbf{b} \quad (3.20)$$

Coefficient c_0 is still unknown. It is determined by setting $E(\omega) = 0$ as $\omega \rightarrow 0$, it follows

$$c_0 = 1 - 2 \sum_{k=1}^{(L-1)/2} c_k \quad (3.21)$$

The features of the maximally flat compensators are illustrated by the compensation of the CIC filter with $N = 7$ and $R = 16$. Figure 3.7 shows the compensated responses for $L = 1, 3, 5, 7, 9$, and 17 where $L = 1$ corresponds to the original response. The CIC filter introduces the droop of 4 dB. It is clear that droop is improved over the wide band if L increases. For example, for the passband edge frequency $\omega_p = 2\pi/5$, the droop of 0.1 dB is achieved for $L \geq 9$. Figure 3.8 shows the bandwidth of the compensated CIC filters where the maximum passband deviation is 0.1 dB. The curves are plotted for the CIC filters with $1 \leq N \leq 7$ and $R = 16$. It is clear that the bandwidth significantly increases with an increase in

L . However, for compensators with higher number of coefficients the reduction is insignificant.

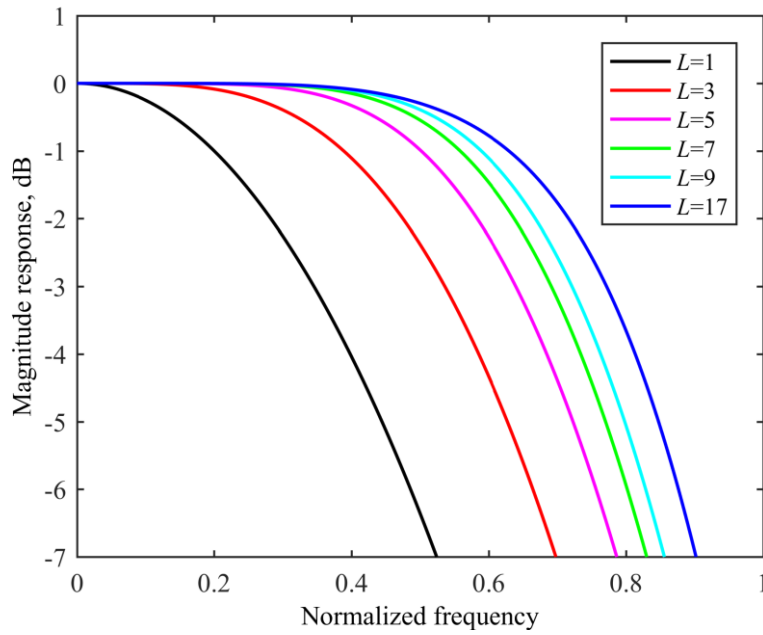

Figure 3.7 Magnitude responses of original and compensated CIC filter with $N = 7$ and $R = 16$ using compensators with up to 17 coefficients [32].

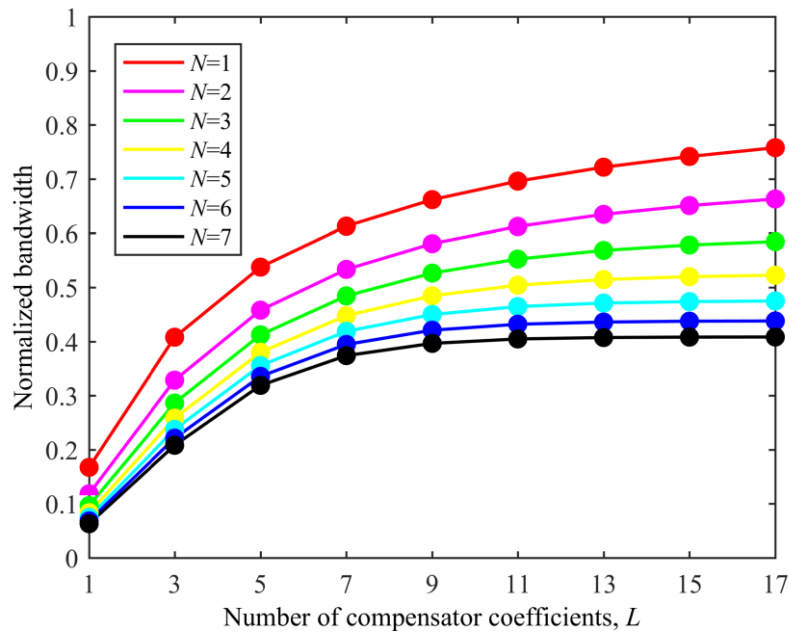

Figure 3.8 Normalized bandwidths of compensated CIC filters of various orders within which maximum passband deviation is 0.1 dB [32].

3.3.2.2 Multiplierless realization

In general, the coefficients of maximally flat compensators take real values. However, in particular cases they can be expressed as SPT, thus providing multiplierless structures. These structures have been proposed by Vazquez and Doleček in [42].

To obtain the coefficients, the authors defined error function

$$E(\omega) = H(R\omega)H_{CIC}(\omega) - 1 \quad (3.22)$$

where $H(R\omega)$ is the amplitude response of the compensator relative to the high sampling rate. To satisfy maximal flat criterion at $\omega = 0$, first n derivatives of the error function in (3.22) at $\omega = 0$ are set to 0. It results in

$$E(0) = H(0) - 1 = 0 \quad (3.23)$$

$$E^{(n)}(\omega) \Big|_{\omega=0} = H_{CIC}^{(n)}(\omega) \Big|_{\omega=0} + \sum_{l=1}^n \binom{n}{l} \left[H^{(l)}(R\omega) \cdot H_{CIC}^{(n-l)}(\omega) \right] \Big|_{\omega=0} = 0 \quad (3.24)$$

The responses $H(R\omega)$ is even function of ω . Therefore, its odd-order derivatives at $\omega = 0$ are set to 0. The even-order derivatives of $H(R\omega)$ when $\omega = 0$ are given by

$$H^{(l)}(R\omega) \Big|_{\omega=0} = 2 \cdot (-1)^{l/2} R^l \cdot \sum_{k=1}^{(L-1)/2} c_k k^l \quad (3.25)$$

Substituting (3.25) into (3.24) and setting $n = 2q$, (3.24) can be rewritten as

$$2 \sum_{l=1}^q \binom{2q}{2l} (-1)^l R^{2l} \cdot \sum_{k=1}^{(L-1)/2} c_k \cdot k^{2l} \left[H_{CIC}^{(2q-2l)}(\omega) \right] \Big|_{\omega=0} = -H_{CIC}^{(2q)}(\omega) \Big|_{\omega=0} \quad (3.26)$$

The optimum compensator's coefficients are obtained by solving the system of linear equations in (3.23) and (3.26). These coefficients are identical to the coefficients obtained by design in [32]. However, in addition to the design procedure, Vazquez and Doleček proposed the multiplierless realization of maximally flat compensators having three and five coefficients.

For the compensators with $L = 3$, the equations in (3.23) and (3.26) can be written as

$$c_0 + 2c_1 = 1 \quad (3.27)$$

$$c_1 = \frac{1}{2R^2} H_{CIC}^{(2)} \Big|_{\omega=0} \quad (3.28)$$

where

$$H_{CIC}^{(2)} \Big|_{\omega=0} = -\frac{N(R^2 - 1)}{12} \quad (3.29)$$

Solving the system in (3.27)–(3.29), the coefficients are obtained as

$$c_1 = -2^{-5} N \frac{1 - R^{-2}}{1 - 2^{-2}} \quad , \quad c_0 = 1 - 2c_1 \quad (3.30)$$

By defining $A = (1 - R^{-2})/(1 - 2^{-2})$, the coefficients take the form

$$c_1 = -2^{-5} NA \quad , \quad c_0 = 1 + 2^{-4} NA \quad (3.31)$$

Figure 3.9 shows the realization of maximally flat compensators with three coefficients. To ensure multiplierless realization, constant multiplier A needs to be defined in SPT space. This is achieved for the decimation factors equal to a power of two. Moreover, A is represented with the directed acyclic graph described in Section 3.2.3.

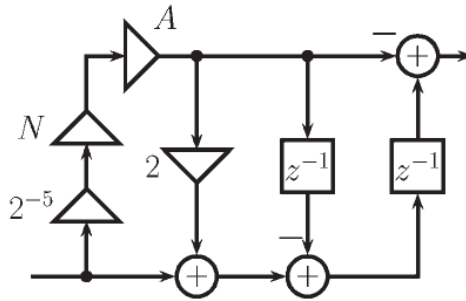

Figure 3.9 Multiplierless realization of maximally flat compensator with three coefficients [42].

For the compensators with $L = 5$, the coefficients have the form

$$c_2 = 2^{-8} NB(2^{-3} NB + 1 - 2^{-2} C) \quad (3.32)$$

$$c_1 = -2^{-6} NB(2^{-3} NB + 3 - 2^{-2} C) \quad (3.33)$$

$$c_0 = 1 - 2(c_1 + c_2) \tag{3.34}$$

where B and C are given by

$$B = \frac{1 - R^{-2}}{1 - 2^{-2}} \tag{3.35}$$

$$C = \frac{1 - (2R)^{-2}}{1 - 2^{-4}} \tag{3.36}$$

Figure 3.10 shows the realization of maximally flat compensators with five coefficients. Here, a multiplierless realization is also achieved for decimation factors equal to powers of two. Constant multipliers B and C are also represented with the directed acyclic graphs.

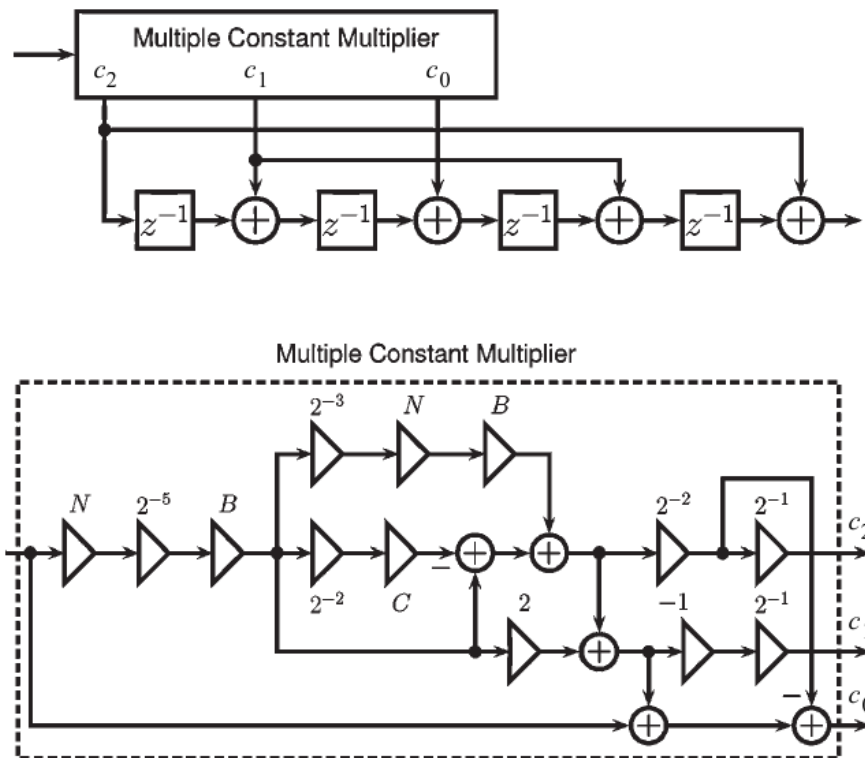

Figure 3.10 Multiplierless realization of maximally flat compensator with five coefficients [42].

3.3.3 Minimax compensators with five coefficients

Recently, Romero and Jimenez [43] proposed the design of efficient wideband compensators based on the minimax error criterion. They deal with the error function

$$\varepsilon(\mathbf{c}) = \max_{0 \leq \omega \leq \pi/2} |1 - H(\omega, \mathbf{c})H_C(\omega)| \quad (3.37)$$

where $\mathbf{c} = [c_0, c_1, c_2]^T$. To obtain multiplierless compensator, each coefficient in \mathbf{c} is represented in CSD space. The optimum coefficients are obtained by solving the problem

$$\begin{aligned} \hat{\mathbf{c}} &= \arg \min_{\mathbf{c}} [\varepsilon(\mathbf{c})] \\ \text{subject to: } & H(0, \mathbf{c}) = 1 \\ & \mathbf{c} \in \text{CSD} \end{aligned} \quad (3.38)$$

The problem in (3.38) is solved using the *particle swarm optimization algorithm*. An additional reduction of compensator's complexity is achieved by searching identical expressions, called *sub-expressions*, among the filter's coefficients. The obtained sub-expressions are realized only ones and then shared between the coefficients.

For the CIC filters with $1 \leq N \leq 6$ and $R = 16$, the optimum coefficients and the corresponding sub-expressions together with the adder cost are given in Table 3.3. In addition, the authors proposed the multiplierless structure of the compensator. Figure 3.11 shows the compensator structure for the CIC filters with $N = 4$.

Table 3.3 Compensator coefficients, sub-expressions, and adder cost N_A for CIC filters with $1 \leq N \leq 6$ and $R = 16$, assuming $\omega_p = \pi/2$ [43].

Sub-expressions: $x_1 = 2^2 - 1$, $x_2 = 2^2 + 1$, $x_3 = 2^3 - 1$, $x_4 = 2^3 + 1$				
N	c_2	c_1	c_0	N_A
1	2	$-(2x_4)$	2^5x_4	5
2	x_2	$-(2^3x_2)$	$2^6x_2 + 2x_1$	7
3	x_4	$-(2^6 + 1)$	$2^9 - 2^4x_4$	7
4	$2x_3$	$-(2^5x_1 - 2)$	$2^7x_1 + 2^5$	8
5	$2^4 + x_2$	$-(2^7 + 1)$	$2^9 - 2^3x_2$	8
6	$2^5 - x_1$	$-(2^7 + 2^3x_2)$	$2^9 + 2^5 - 2x_2$	10

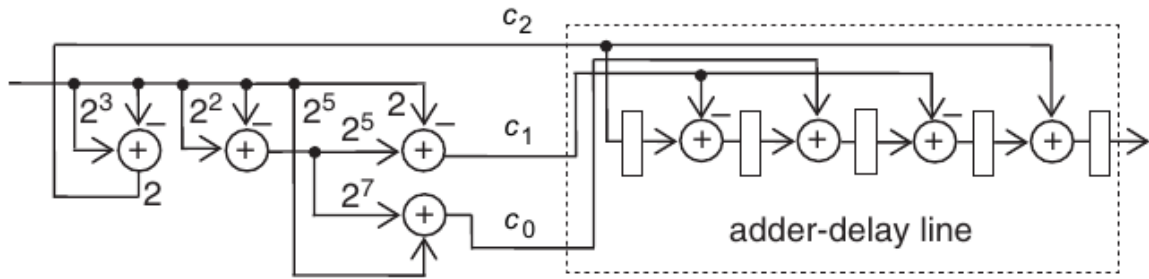

Figure 3.11 Multiplierless realization of minmax compensator for CIC filter with $N = 4$ [43].

Figure 3.12 shows the maximum passband deviations of the compensated CIC filters of various orders. The compensators improve the wide passband efficiently providing the deviations up to 0.07 dB. However, such a high passband improvement is paid with the adder cost of up to ten adders.

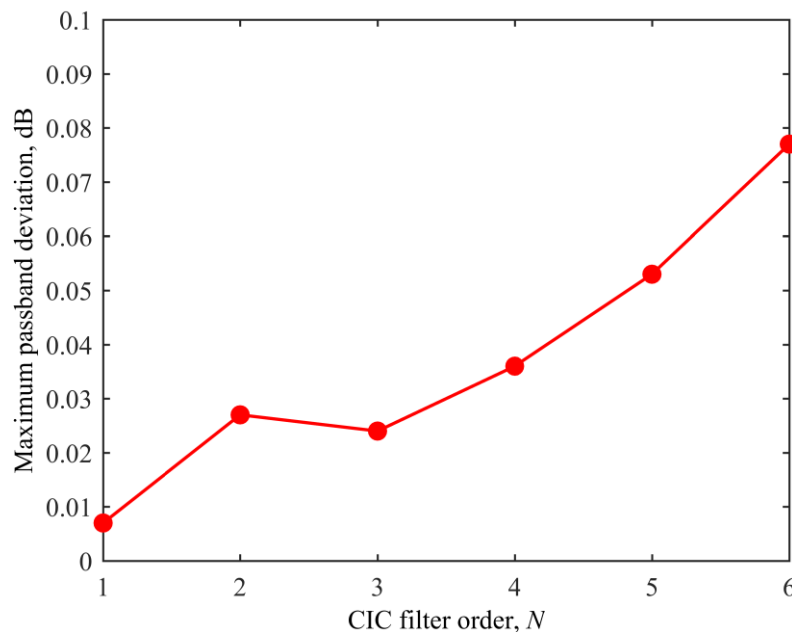

Figure 3.12 Maximum passband deviations of compensated CIC filters with $1 \leq N \leq 6$ and $R = 16$, assuming $\omega_p = \pi/2$ [43].

3.3.4 Minimum phase compensators

In general, *minimum-phase FIR filters* can have identical amplitude responses as linear-phase FIR filters by using less complex structures. Such filters are appropriate for low-delay applications. In [38], Romero *et al.* proposed the design of simple minimum-phase compensators having the magnitude response

$$|H(e^{j\omega})| = \sqrt{1 + A \sin^2(\omega/2)} \quad (3.39)$$

The multiplierless realization is ensured by setting $A = 2^d(1 + 2^{d-2})$, where d takes an integer value. The corresponding transfer function has the form

$$H(z) = 1 + 2^{d-2} - 2^{d-2} z^{-1} \quad (3.40)$$

The function in (3.40) has a root in $z_{root} = 2^{d-2}/(1 + 2^{d-2})$. Therefore, the minimum phase is achieved for any d .

Figure 3.13 shows the realization of the described compensators. It is clear from the figure that these compensators employ only two adders in total.

For the CIC filters with $2 \leq N \leq 6$ and $R = 16$, and assuming $\omega_p = \pi/8$ and $\omega_p = 3\pi/5$, the optimum values of d together with the corresponding adder cost are given in Table 3.4. In addition, Figure 3.14 shows the passband deviations obtained by the narrowband compensation. It is clear that the deviations up to 0.15 dB are achieved by using two adders only.

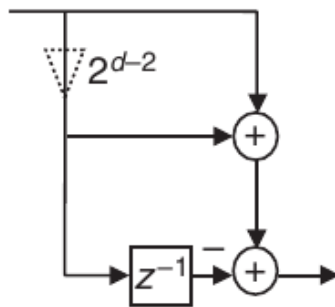

Figure 3.13 Multiplierless realization of minimum-phase compensator [38].

Table 3.4 Values of parameter d together with adder cost N_A for CIC filters with $2 \leq N \leq 6$ and $R = 16$ [38].

N	$\omega_p = \pi/8$		$\omega_p = 3\pi/5$	
	d	N_A	d	N_A
2	-1	2	0	2
3	-1	2	0	2
4	0	2	1	2
5	0	2	1	2
6	1	2	1 or 2	2

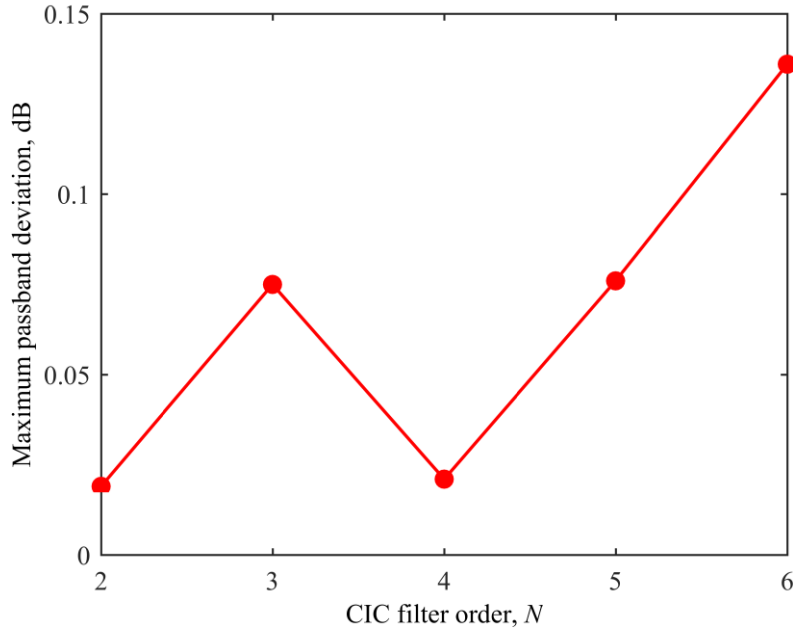

Figure 3.14 Maximum passband deviations of original and compensated CIC filters with $2 \leq N \leq 6$ and $R = 16$, assuming $\omega_p = \pi/8$ [38].

3.3.5 Multi-stage compensators

In many applications, single-stage compensators are sufficient. However, the wideband applications requiring significant droop reduction prefer *multi-stage compensators*. These compensators are realized as the cascades of several single-stage compensators. In the following sections, two-stage compensators [44] and compensators with arbitrary number of stages [45] are presented.

3.3.5.1 Two-stage compensators

In [44], Doleček *et al.* proposed a two-stage compensator with high compensation capability. They define the overall magnitude response of the compensator as

$$\begin{aligned}
 |H(e^{j\omega})| &= |H_1(e^{j\omega})H_2(e^{j\omega})| \\
 |H_1(e^{j\omega})| &= |1 + B_1 \sin^4(\omega/2)| \\
 |H_2(e^{j\omega})| &= |1 + B_2 \sin^2(\omega/2)|
 \end{aligned} \tag{3.41}$$

where B_1 and B_2 are the parameters of the sine-based compensators, described in Section 3.3.1. From (3.41), the compensator transfer function is obtained as

$$\begin{aligned}
 H(z) &= H_1(z)H_2(z) \\
 H_1(z) &= 2^{-4} B_1 \left[1 + z^{-4} - 4(z^{-1} + z^{-3}) + (2^2 + 2)z^{-2} \right] + z^{-2} \\
 H_2(z) &= 2^{-2} \left[(-1 + 2z^{-1} - z^{-2})B_2 + 2^2 z^{-1} \right]
 \end{aligned} \tag{3.42}$$

To obtain B_1 and B_2 , the authors assumed that response $H(e^{j\omega})$ is approximately equal to the unity in two arbitrary frequency points, ω_1 and ω_2 . For high decimation factors, this assumption results in approximations of B_1 and B_2 as in

$$\begin{aligned}
 B_1 &\approx \frac{-1 + \left[\frac{\omega_2/2}{\sin(\omega_2/2)} \right]^N}{1 + B_2 \sin^2(\omega_2/2)} \\
 &\quad \frac{\sin^4(\omega_2/2)}{\sin^4(\omega_2/2)} \\
 B_2 &\approx \frac{-1 + \left[\frac{\omega_1/2}{\sin(\omega_1/2)} \right]^N}{\sin^2(\omega_1/2)}
 \end{aligned} \tag{3.43}$$

It is clear from (3.43) that the values of B_1 and B_2 are not SPT representable. Therefore, B_1 is rounded to the closest power of two. Afterward, the new value of B_2 is obtained using the rounded value of B_1 and then applying the design procedure described in Section 3.3.1.2. Such design is described as in

$$\begin{aligned}
 B_2 &= \min_k b_k \\
 \text{subject to: } b_k &= \frac{-\left\{ 1 + B_1 \sin^2 \left[\pi k / (4K) \right] \right\} 10^{\delta_p / 40} - \left\{ \frac{\pi k / (4K)}{\sin \left[\pi k / (4K) \right]} \right\}^N}{\left[1 + B_1 \sin^2 \left[\pi k / (4K) \right] \right] \sin^2 \left[\pi k / (4K) \right]} \\
 &\quad k = 1, \dots, K
 \end{aligned} \tag{3.44}$$

where δ_p is maximum passband deviation of the compensated response and K is a number of uniformly spaced frequency points within the passband. The problem in (3.44) is simple. Therefore, for its solving, the authors suggested exhaustive search. Furthermore, since the optimum values of B_2 are not SPT representable, they recommended the rounding of B_2 to $r = 2^{-6}$.

The features of the method are illustrated with the design of wideband compensators, assuming $\omega_1 = \omega_p/4$, $\omega_2 = \omega_p = \pi/2$, and $\delta_p = 0.1$ dB for each sine-based compensator. The

design is performed for the CIC filters with $1 \leq N \leq 6$ and $R = 16$. The obtained SPT values of B_1 and B_2 together with the adder cost are given in Table 3.5.

Table 3.5 Values of B_1 and B_2 together with adder cost N_A for CIC filters with $1 \leq N \leq 6$ and $R = 16$, assuming $\omega_p = \pi/2$ and $\delta_p = 0.1$ [44].

N	B_1	B_2	N_A
1	0	$2^{-2} - 2^{-5}$	4
2	2^{-2}	$2^{-2} + 2^{-4}$	10
3	2^{-1}	$2^{-1} - 2^{-4}$	10
4	2^{-1}	$2^{-1} + 2^{-3} + 2^{-4}$	11
5	1	$1 - 2^{-2} - 2^{-5}$	11
6	1	$1 - 2^{-6}$	10

In addition, Figure 3.15 shows the maximum passband deviations of the compensated CIC filters of various orders. The deviation less than 0.1 dB is achieved by the structure employing up to 11 adders.

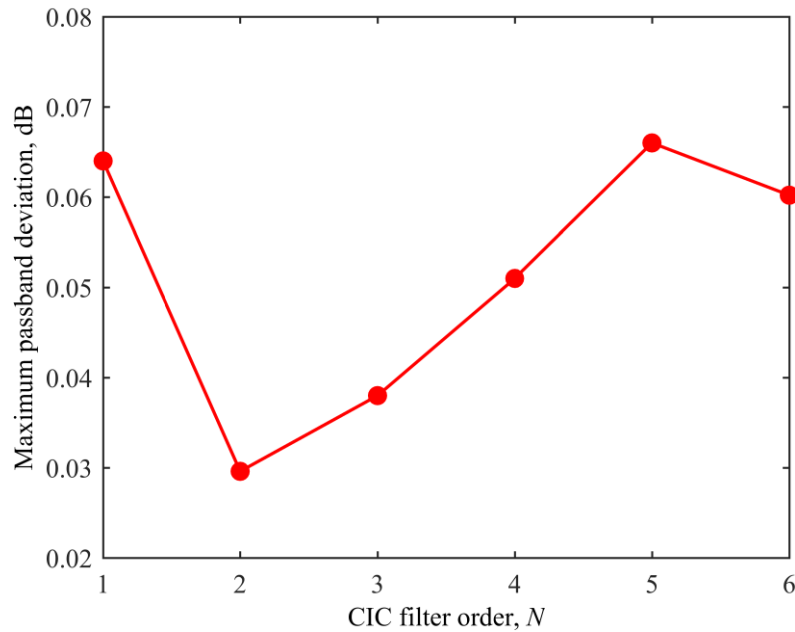

Figure 3.15 Maximum passband deviations of original and compensated CIC filters with $1 \leq N \leq 6$ and $R = 16$, assuming $\omega_p = \pi/2$ [44].

3.3.5.2 Compensator with arbitrary number of stages

In [45], Romero proposed the design of wideband multi-stage compensators with an arbitrary number of stages. These compensators are obtained by cascading the compensators

with the same transfer function. In the paper referred to, the author uses the following function

$$H(z) = 1 + 2^{-3} - 2^{-3} z^{-1} \quad (3.45)$$

The optimum number of cascades, K , is obtained by approximating the ideal compensator response in a minimax sense within the passband $\omega_p = \pi/2$. Such a design problem is described by

$$\hat{K} = \arg \min_{0 \leq \omega \leq \pi/2} \left\| H_{\text{ideal}}(\omega) - |H(e^{j\omega})|^K \right\| \quad (3.46)$$

The optimum values of K for various orders of the CIC filters with $R = 16$ are given by

$$K = \begin{cases} N & ; \quad N \leq 2 \\ N-1 & ; \quad 3 \leq N \leq 6 \\ N-2 & ; \quad N \geq 7 \end{cases} \quad (3.47)$$

Figure 3.16 shows the maximum passband deviations of the original and compensated CIC filters of various orders. The deviations less than 0.6 dB are obtained by employing the compensators with up to 10 adders.

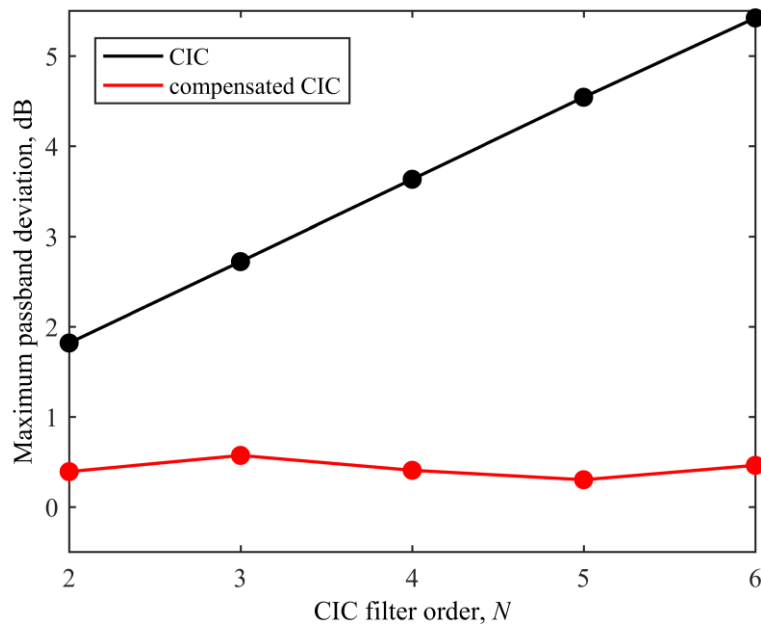

Figure 3.16 Maximum passband deviations of original and compensated CIC filters with $2 \leq N \leq 6$ and $R = 16$, assuming $\omega_p = \pi/2$ [45].

3.4 CIC compensators with minimum passband deviation

Common approach in the design of compensators is based on the minimization of maximum absolute passband deviation. However, in the design of compensators with SPT coefficients, the minimization of the difference between maximum and minimum passband response opens a possibility for further passband improvement. Recently, two classes of such compensators have been proposed. They cover the transfer functions with unity [48] and non-unity gain [49]. In this section, these functions and the corresponding multiplierless structures are described in detail.

3.4.1 Compensators with unity gain

3.4.1.1 Objective function

To preserve the gain of a CIC filter, the compensation is performed by using the transfer functions with unity gain. In [48], unity gain is ensured by setting $H(0) = 1$. Consequently, central coefficient c_0 takes the value

$$c_0 = 1 - 2 \sum_{k=1}^{(L-1)/2} c_k \quad (3.48)$$

By substituting (3.48) into (3.3), the amplitude response of the compensator takes the form

$$H(\omega) = 1 + 2 \sum_{k=1}^{(L-1)/2} c_k [\cos(k\omega) - 1] \quad (3.49)$$

To obtain compensator's coefficients, the error function is defined as the difference between the maximum and the minimum passband amplitude, as in

$$\varepsilon(\mathbf{c}) = \max_{\omega \in \Omega} H_C(\omega)H(\omega, \mathbf{c}) - \min_{\omega \in \Omega} H_C(\omega)H(\omega, \mathbf{c}) \quad (3.50)$$

where $\mathbf{c} = [c_1, c_2, \dots, c_{(L-1)/2}]^T$ is the vector of compensator's coefficients and $\Omega = [-\omega_p, \omega_p]$, $0 < \omega_p < \pi$, is the passband. In the design of the compensators, $\varepsilon(\mathbf{c})$ is calculated by using the responses evaluated on uniformly spaced frequency grid $Q = \{\omega_k, k=0, \dots, K-1\}$ defined within Ω . Hence, the objective function is obtained as

$$\varepsilon(\mathbf{c}) = \max_{\omega_k \in Q} H_C(\omega_k)H(\omega_k, \mathbf{c}) - \min_{\omega_k \in Q} H_C(\omega_k)H(\omega_k, \mathbf{c}) \quad (3.51)$$

To find the optimum SPT coefficients, the number of SPT terms per coefficient is restricted to a value P . Therefore, the optimum coefficients providing minimum passband deviation are obtained by solving the problem

$$\begin{aligned} \hat{\mathbf{c}} &= \arg \min [\varepsilon(\mathbf{c})] \\ \text{subject to: } c_k &= \sum_{p=0}^{W-1} b_{k,p} 2^{-p} \quad ; \quad k = 1, 2, \dots, \frac{L-1}{2} \\ \sum_{p=0}^{W-1} |b_{k,p}| &= P \quad ; \quad k = 1, 2, \dots, \frac{L-1}{2} \\ H(0, \mathbf{c}) &= 1 \end{aligned} \quad (3.52)$$

where $b_{k,p} \in \{-1, 0, 1\}$ and W is the wordlength of compensator's coefficients.

3.4.1.2 Optimization based on interval analysis

To solve the problem in (3.51) and (3.52), a global optimization technique based on the *interval analysis* is used [50], [51]. The main idea of the interval analysis is bounding the result of an operation or function. Instead of numbers, the interval analysis deals with interval numbers, or shortly, intervals. A real interval number \mathbf{x} is equivalent to the closed interval

$$\mathbf{x} = [\underline{x}, \bar{x}] \quad (3.53)$$

where \underline{x} and \bar{x} denote the interval's lower and upper bound. For real intervals, elementary operations are defined in [50], [51]. The interval extensions can be obtained for elementary functions as well.

Let the optimization problem have the form

$$\mathbf{x}_{opt} = \arg \min_{\mathbf{x}} [f(\mathbf{x})] \quad (3.54)$$

where \mathbf{x}_{opt} is expected within the box

$$\mathbf{X}_0 = \left\{ (x_1, x_2, \dots, x_n)^T \in \mathfrak{R}^n \mid \underline{x}_i \leq x_i \leq \bar{x}_i, 1 \leq i \leq n \right\} \quad (3.55)$$

Using the interval analysis, this problem can be solved globally.

The optimization based on the interval analysis uses a branch and bound algorithm. The basic algorithm operates with an upper bound of the global solution, $\bar{\phi}$, and with two lists of boxes, called the input list and the final list. In the beginning, $\bar{\phi}$ is assumed. The input list contains only the initial box, X_0 , whereas the final list is empty. The lists are then processed by using the following procedure [50], [51]:

1. Remove the box X from the input list.
2. Calculate the interval extension of the function f as $y = f(X)$. Note that $y = [\underline{y}, \bar{y}]$, where \underline{y} is the lower and \bar{y} is the upper bound of f within the box X . Depending on y , the following actions are performed:
 - a. If $\bar{y} < \bar{\phi}$, then $\bar{\phi} = \bar{y}$ is a new bound for y .
 - b. If $\underline{y} > \bar{\phi}$, then X does not contain the optimum. Discard X from further analysis.
 - c. If $\underline{y} \leq \bar{\phi}$, it is still possible that X contains the global optimum. If the size of X is smaller than some prescribed tolerance, insert X in the final list. Otherwise, split X into two boxes and insert them in the input list.
3. Repeat steps 1 and 2 if the input list is not empty.

The result of this procedure is the final list, which contains a set of small boxes in which the global optimum is placed.

The above algorithm works with continuous variables. In [52], this algorithm is modified to deal with SPT variables. Such an algorithm has already been applied in the design of multiplierless FIR filters [52] and CIC compensators [53]. Here, it is used to solve the optimization problem in (3.51) and (3.52).

3.4.1.3 Compensator structure

Figures 3.17 and 3.18 show the multiplierless structures of the obtained compensators with three and five coefficients. It is clear that the computational complexity of the compensators depends on the implementations of constant multipliers. Since each SPT coefficient employs $P - 1$ adders, the total number of adders required in the structure is

$$N_A = P + 2 \quad (3.56)$$

for the compensator with three coefficients, and

$$N_A = 2(P+2) \tag{3.57}$$

for the compensator with five coefficients.

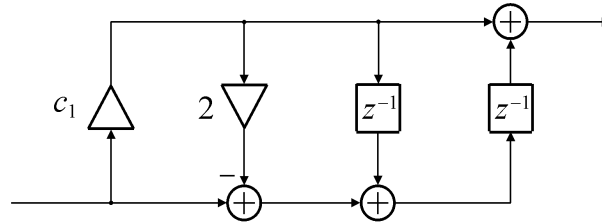

Figure 3.17 Multiplierless structure of unity-gain CIC compensator with three coefficients providing minimum passband deviation [48].

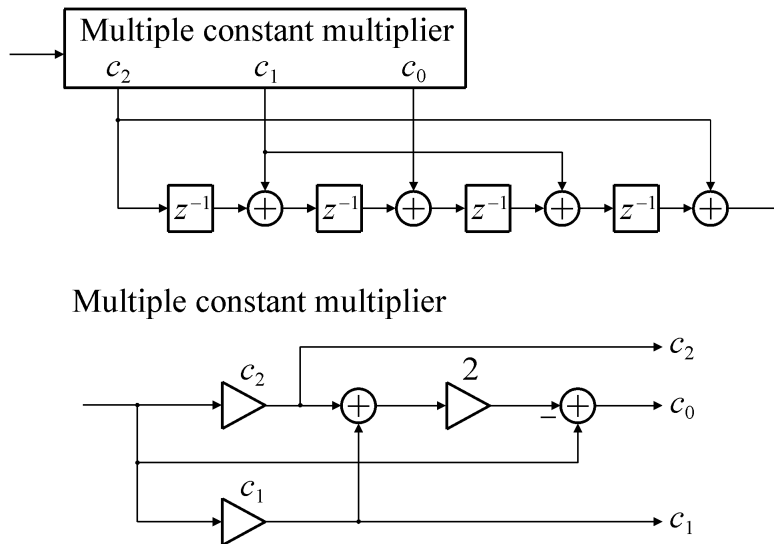

Figure 3.18 Multiplierless structure of unity-gain CIC compensator with five coefficients providing minimum passband deviation [48].

3.4.1.4 Design examples

The features of the proposed technique are illustrated with the design of narrowband and wideband compensators. The design is performed for CIC filters with decimation factor $R = 32$ and $K = 1024$ frequency points. The optimum SPT coefficients are found for $W = 18$. The coefficients obtained are given in Tables 3.6 and 3.7. They are tabulated for various passband edge frequencies and CIC filter orders. It is well known that for a given order of the CIC filter, the amplitude response negligibly changes the shape within the passband for

$R \geq 10$ [3]. In that sense, the tabulated coefficients can be used for compensation of any CIC filter with $R \geq 10$.

Table 3.6 Optimum SPT coefficients with P terms of compensators for CIC filter with $2 \leq N \leq 4$ and $R \geq 10$, obtained for various passband edge frequencies ω_p [48].

	$P=1$	$P=2$	$P=3$	$P=1$	$P=2$	$P=3$	$P=1$	$P=2$	$P=3$
c_k	$N=2$			$N=3$			$N=4$		
$L=3$ and $\omega_p=\pi/5$									
c_1	-2^{-4}	$-2^{-4}2^{-5}$	$-2^{-4}2^{-6}2^{-7}$	-2^{-3}	$-2^{-3}2^{-7}$	$-2^{-3}2^{-7}2^{-14}$	-2^{-3}	$-2^{-3}2^{-4}$	$-2^{-3}2^{-4}2^{-7}$
$L=3$ and $\omega_p=\pi/4$									
c_1	-2^{-4}	$-2^{-4}2^{-5}$	$-2^{-4}2^{-5}2^{-8}$	-2^{-3}	$-2^{-3}2^{-6}$	$-2^{-3}2^{-7}2^{-8}$	-2^{-3}	$-2^{-3}2^{-4}$	$-2^{-3}2^{-4}2^{-9}$
$L=3$ and $\omega_p=\pi/3$									
c_1	-2^{-3}	$-2^{-4}2^{-5}$	$-2^{-4}2^{-5}2^{-9}$	-2^{-3}	$-2^{-3}2^{-6}$	$-2^{-3}2^{-6}2^{-7}$	-2^{-2}	$-2^{-3}2^{-4}$	$-2^{-3}2^{-4}2^{-6}$
$L=3$ and $\omega_p=\pi/2$									
c_1	-2^{-3}	$-2^{-3}2^{-7}$	$-2^{-3}2^{-7}2^{-11}$	-2^{-3}	$-2^{-3}2^{-4}$	$-2^{-3}2^{-4}2^{-9}$	-2^{-2}	$-2^{-2}2^{-7}$	$-2^{-2}2^{-7}2^{-9}$
$L=5$ and $\omega_p=\pi/3$									
c_1	-2^{-3}	$-2^{-3}2^{-6}$	$-2^{-3}2^{-6}2^{-11}$	-2^{-2}	$-2^{-2}2^{-5}$	$-2^{-2}2^{-5}2^{-11}$	-2^{-2}	$-2^{-2}2^{-5}$	$-2^{-2}2^{-4}2^{-7}$
c_2	2^{-7}	$2^{-6}2^{-10}$	$2^{-6}2^{-10}2^{-14}$	2^{-5}	$2^{-5}2^{-7}$	$2^{-5}2^{-7}2^{-12}$	2^{-6}	$2^{-5}2^{-8}$	$2^{-5}2^{-7}2^{-11}$
$L=5$ and $\omega_p=2\pi/5$									
c_1	-2^{-3}	$-2^{-3}2^{-6}$	$-2^{-3}2^{-6}2^{-8}$	-2^{-2}	$-2^{-2}2^{-7}$	$-2^{-2}2^{-6}2^{-10}$	-2^{-2}	$-2^{-2}2^{-4}$	$-2^{-2}2^{-4}2^{-5}$
c_2	2^{-7}	$2^{-6}2^{-10}$	$2^{-6}2^{-12}2^{-14}$	2^{-5}	$2^{-5}2^{-12}$	$2^{-5}2^{-9}2^{-12}$	2^{-6}	$2^{-5}2^{-8}$	$2^{-4}2^{-6}2^{-12}$
$L=5$ and $\omega_p=\pi/2$									
c_1	-2^{-3}	$-2^{-3}2^{-5}$	$-2^{-3}2^{-5}2^{-11}$	-2^{-2}	$-2^{-2}2^{-8}$	$-2^{-2}2^{-8}2^{-10}$	-2^{-2}	$-2^{-2}2^{-3}$	$-2^{-2}2^{-3}2^{-9}$
c_2	2^{-8}	$2^{-6}2^{-8}$	$2^{-6}2^{-8}2^{-11}$	2^{-5}	$2^{-5}2^{-8}$	$2^{-5}2^{-8}2^{-10}$	-2^{-8}	$2^{-4}2^{-8}$	$2^{-4}2^{-8}2^{-11}$
$L=5$ and $\omega_p=3\pi/5$									
c_1	-2^{-3}	$-2^{-3}2^{-5}$	$-2^{-3}2^{-5}2^{-6}$	-2^{-2}	$-2^{-2}2^{-5}$	$-2^{-2}2^{-5}2^{-14}$	-2^{-1}	$-2^{-1}2^{-4}$	$-2^{-1}2^{-4}2^{-6}$
c_2	2^{-7}	$2^{-6}2^{-8}$	$2^{-5}2^{-8}2^{-12}$	2^{-5}	$2^{-4}2^{-6}$	$2^{-4}2^{-6}2^{-10}$	2^{-3}	$2^{-4}2^{-6}$	$2^{-4}2^{-6}2^{-9}$
$L=5$ and $\omega_p=2\pi/3$									
c_1	-2^{-3}	$-2^{-3}2^{-4}$	$-2^{-3}2^{-4}2^{-7}$	-2^{-2}	$-2^{-2}2^{-4}$	$-2^{-2}2^{-4}2^{-7}$	-2^{-1}	$-2^{-1}2^{-4}$	$-2^{-1}2^{-4}2^{-6}$
c_2	2^{-7}	$2^{-5}2^{-8}$	$2^{-5}2^{-10}2^{-12}$	2^{-5}	$2^{-4}2^{-9}$	$2^{-4}2^{-10}2^{-11}$	2^{-3}	$2^{-3}2^{-5}$	$2^{-3}2^{-5}2^{-8}$

Table 3.7 Optimum SPT coefficients with P terms of compensators for CIC filter with $5 \leq N \leq 7$ and $R \geq 10$, obtained for various passband edge frequencies ω_p [48].

	$P=1$	$P=2$	$P=3$	$P=1$	$P=2$	$P=3$	$P=1$	$P=2$	$P=3$
c_k	$N=5$			$N=6$			$N=7$		
$L=3$ and $\omega_p=\pi/5$									
c_1	-2^{-2}	$-2^{-2}+2^{-5}$	$-2^{-2}+2^{-5}-2^{-7}$	-2^{-2}	$-2^{-2}-2^{-6}$	$-2^{-2}-2^{-6}-2^{-7}$	-2^{-2}	$-2^{-2}-2^{-4}$	$-2^{-2}-2^{-4}-2^{-7}$
$L=3$ and $\omega_p=\pi/4$									
c_1	-2^{-2}	$-2^{-2}+2^{-6}$	$-2^{-2}+2^{-6}-2^{-10}$	-2^{-2}	$-2^{-2}-2^{-5}$	$-2^{-2}-2^{-5}-2^{-8}$	-2^{-2}	$-2^{-2}-2^{-4}$	$-2^{-2}-2^{-4}-2^{-5}$
$L=3$ and $\omega_p=\pi/3$									
c_1	-2^{-2}	$-2^{-2}-2^{-7}$	$-2^{-2}-2^{-7}-2^{-10}$	-2^{-2}	$-2^{-2}-2^{-4}$	$-2^{-2}-2^{-4}-2^{-8}$	-2^{-1}	$-2^{-2}-2^{-3}$	$-2^{-2}-2^{-3}-2^{-8}$
$L=3$ and $\omega_p=\pi/2$									
c_1	-2^{-2}	$-2^{-2}-2^{-4}$	$-2^{-2}-2^{-4}-2^{-5}$	-2^{-1}	$-2^{-1}+2^{-4}$	$-2^{-1}+2^{-4}-2^{-11}$	-2^{-1}	$-2^{-1}-2^{-5}$	$-2^{-1}-2^{-5}-2^{-7}$
$L=5$ and $\omega_p=\pi/3$									
c_1	-2^{-2}	$-2^{-1}+2^{-4}$	$-2^{-1}+2^{-4}+2^{-6}$	-2^{-1}	$-2^{-1}-2^{-5}$	$-2^{-1}-2^{-4}+2^{-7}$	-2^{-1}	$-2^{-1}-2^{-2}$	$-2^{-1}-2^{-3}-2^{-5}$
c_2	-2^{-9}	$2^{-4}-2^{-9}$	$2^{-4}-2^{-7}-2^{-12}$	2^{-4}	$2^{-4}+2^{-7}$	$2^{-4}+2^{-6}+2^{-10}$	2^{-5}	$2^{-3}-2^{-9}$	$2^{-3}-2^{-5}-2^{-9}$
$L=5$ and $\omega_p=2\pi/5$									
c_1	-2^{-2}	$-2^{-1}+2^{-5}$	$-2^{-1}+2^{-4}-2^{-6}$	-2^{-1}	$-2^{-1}-2^{-4}$	$-2^{-1}-2^{-4}-2^{-6}$	-2^{-1}	$-2^{-1}-2^{-2}$	$-2^{-1}-2^{-2}+2^{-6}$
c_2	-2^{-6}	$2^{-4}+2^{-7}$	$2^{-4}+2^{-9}+2^{-13}$	2^{-4}	$2^{-4}+2^{-6}$	$2^{-3}-2^{-5}-2^{-7}$	2^{-5}	$2^{-3}-2^{-9}$	$2^{-3}-2^{-7}+2^{-10}$
$L=5$ and $\omega_p=\pi/2$									
c_1	-2^{-1}	$-2^{-1}+2^{-9}$	$-2^{-1}-2^{-8}+2^{-11}$	-2^{-1}	$-2^{-1}-2^{-3}$	$-2^{-1}-2^{-3}-2^{-5}$	-2^0	$-2^{-1}-2^{-2}$	$-2^0+2^{-3}+2^{-5}$
c_2	2^{-4}	$2^{-4}+2^{-6}$	$2^{-4}+2^{-6}+2^{-8}$	2^{-5}	$2^{-3}-2^{-5}$	$2^{-3}-2^{-7}-2^{-8}$	2^{-2}	$2^{-3}-2^{-9}$	$2^{-3}+2^{-5}+2^{-9}$
$L=5$ and $\omega_p=3\pi/5$									
c_1	-2^{-1}	$-2^{-1}-2^{-4}$	$-2^{-1}-2^{-4}-2^{-7}$	-2^0	$-2^{-1}-2^{-2}$	$-2^{-1}-2^{-2}-2^{-7}$	-2^0	-2^0+2^{-6}	$-2^0+2^{-5}-2^{-8}$
c_2	2^{-4}	$2^{-3}-2^{-6}$	$2^{-3}-2^{-7}-2^{-8}$	2^{-2}	$2^{-3}+2^{-5}$	$2^{-3}+2^{-5}+2^{-8}$	2^{-2}	$2^{-2}-2^{-5}$	$2^{-2}-2^{-5}-2^{-8}$
$L=5$ and $\omega_p=2\pi/3$									
c_1	-2^{-1}	$-2^{-1}-2^{-3}$	$-2^{-1}-2^{-3}-2^{-10}$	-2^0	-2^0+2^{-3}	$-2^0+2^{-3}+2^{-5}$	-2^0	-2^0-2^{-4}	$-2^0-2^{-4}-2^{-6}$
c_2	2^{-4}	$2^{-3}+2^{-6}$	$2^{-3}+2^{-6}+2^{-9}$	2^{-2}	$2^{-2}-2^{-5}$	$2^{-2}-2^{-5}-2^{-6}$	2^{-2}	$2^{-2}+2^{-6}$	$2^{-2}+2^{-6}+2^{-8}$

Example 1. Narrowband design is illustrated with the compensation of the CIC filter with $N=5$ and $R=32$ by compensators with three coefficients and $P \leq 3$. The passband edge frequency $\omega_p = \pi/5$ is chosen. Figure 3.19 shows compensated passband responses. The uncompensated CIC filter introduces the droop of 0.72 dB. However, the compensated CIC filter yields maximum passband deviation of 0.08 dB for $P=1$, 0.03 dB for $P=2$, and 0.02 dB for $P=3$, resulting in the compensator with three, four, and five adders, respectively.

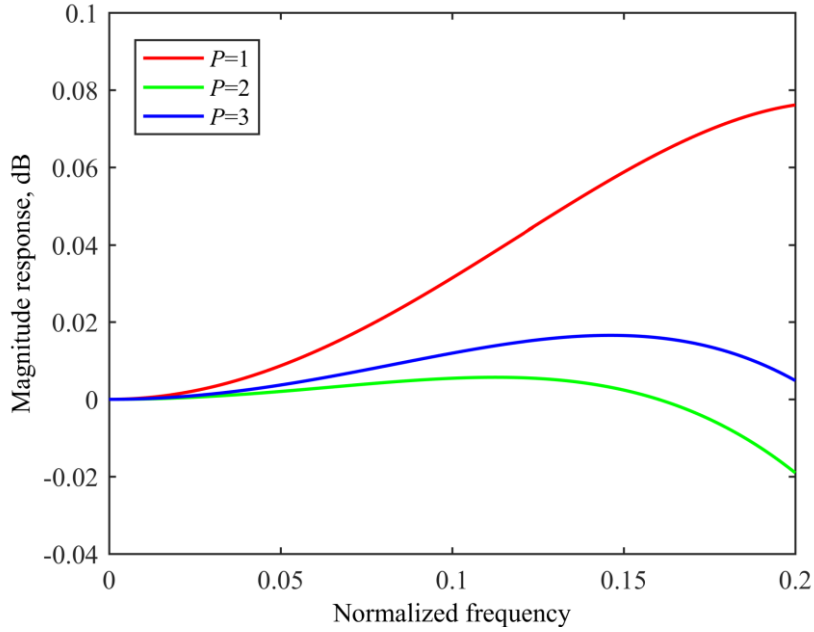

Figure 3.19 Magnitude responses of compensated CIC filter with $N=5$ and $R=32$, assuming $\omega_p = \pi/5$, $L=3$ and $1 \leq P \leq 3$ [48].

Example 2. Simple wideband compensators incorporate only three coefficients, as for example the sine-based compensators described in [41] and [11]. Hence, the proposed wideband compensator with three coefficients and $P=3$ is compared with the compensators referred to. Figure 3.20 shows the obtained passband responses for the CIC filter with $N=5$ and $R=32$, assuming $\omega_p = \pi/2$. The uncompensated CIC filter introduces the droop of 4.6 dB. The compensated response has the passband deviation of 0.58 dB, whereas the deviations in [41] and [11] are 0.71 dB and 0.88 dB. It is clear that the proposed compensation is better. However, in comparison with the compensator in [41], it is paid by increasing the total number of adders by one.

Example 3. Wideband compensation is illustrated with compensation of the CIC filter with $N=5$ and $R=32$ by compensators with five coefficients and $P \leq 3$. For illustration, the passband edge frequency $\omega_p = 3\pi/5$ is chosen. Figure 3.21 shows the obtained passband responses. The CIC filter introduces the droop of 6.6 dB. However, the compensated CIC filter results in maximum deviation of 0.68 dB for $P=1$, 0.28 dB for $P=2$, and 0.25 dB for $P=3$, which are obtained by using six, eight, and ten adders, respectively.

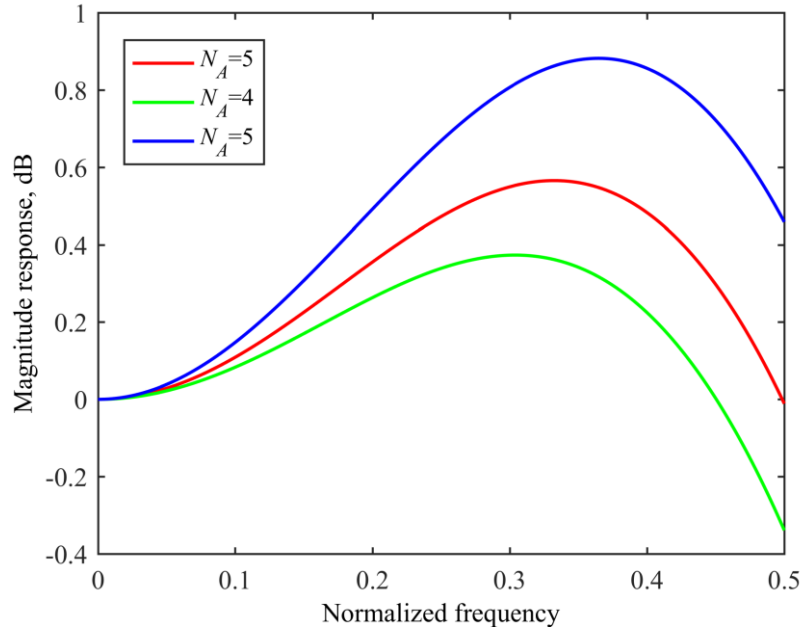

Figure 3.20 Magnitude responses of compensated CIC filter with $N=5$ and $R=32$, assuming $\omega_p = \pi/2$ and $L=3$. For compensation, proposed compensator with $P=3$ (red) and compensators in [41] (green) and [11] (blue) are used. All compensator have N_A adders [48].

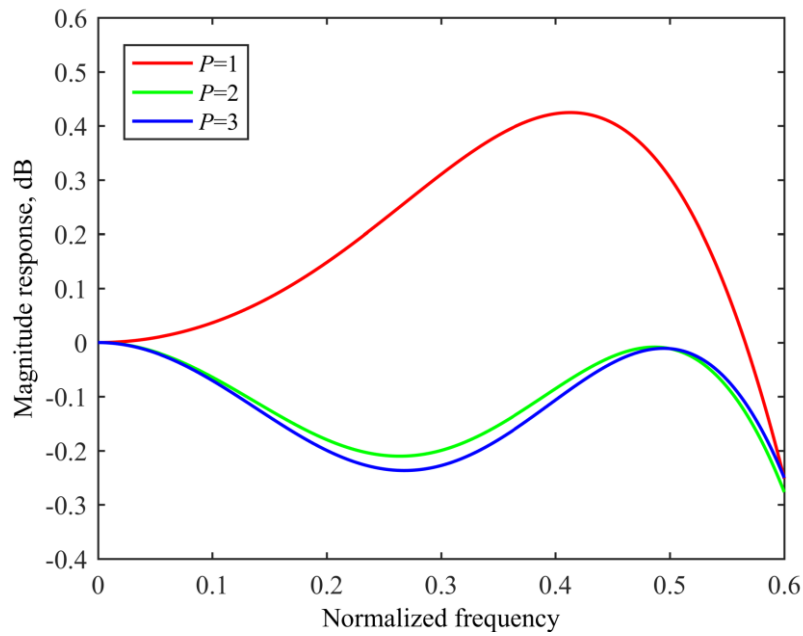

Figure 3.21 Magnitude responses of compensated CIC with $N=5$ and $R=32$, assuming $\omega_p = 3\pi/5$, $N=3$ and $1 \leq P \leq 3$ [48].

Example 4. Recently, a multiplierless CIC compensation using the cascade of two linear-phase compensators has been proposed [44]. In this cascade, the first compensator has three coefficients, whereas the second compensator has five coefficients. Here, the proposed single-stage compensator having five coefficients and $P=2$ is compared to the two-stage multiplierless compensator from [44]. The compensation of the same CIC filter is considered. Figure 3.22 shows the compensated responses obtained for $\omega_p = \pi/2$. Both responses ensure the deviation close to 0.1 dB. However, the proposed compensator employs less number of adders.

Example 5. The proposed compensators can be applied to improve the passband of CIC-based decimation filters proposed in [22]. These filters provide very high stopband attenuations. However, they introduce a rather high passband droop. In the paper referred to, CIC compensators are suggested to reduce the droop. Here, the compensator with five coefficients and $P=2$ are used to improve the filter obtained by $N=10$ and $R=10$ [22]. The passband with $\omega_p = \pi/2$ is chosen. The optimum compensator coefficients are obtained as $c_1 = -1 - 2^{-1}$ and $c_2 = 2^{-2} + 2^{-4}$, resulting in structure with eight adders. Figure 3.23 shows the magnitude response relative to the high sampling rate for compensated CIC-based filter together with the response of the original filter. Figure 3.24 shows the corresponding responses relative to the low sampling rate. The CIC-based filter ensures minimum folding-band attenuation of 128 dB and introduces the droop of 9.4 dB. However, the proposed compensator significantly improves the passband, resulting in the deviation of 0.6 dB.

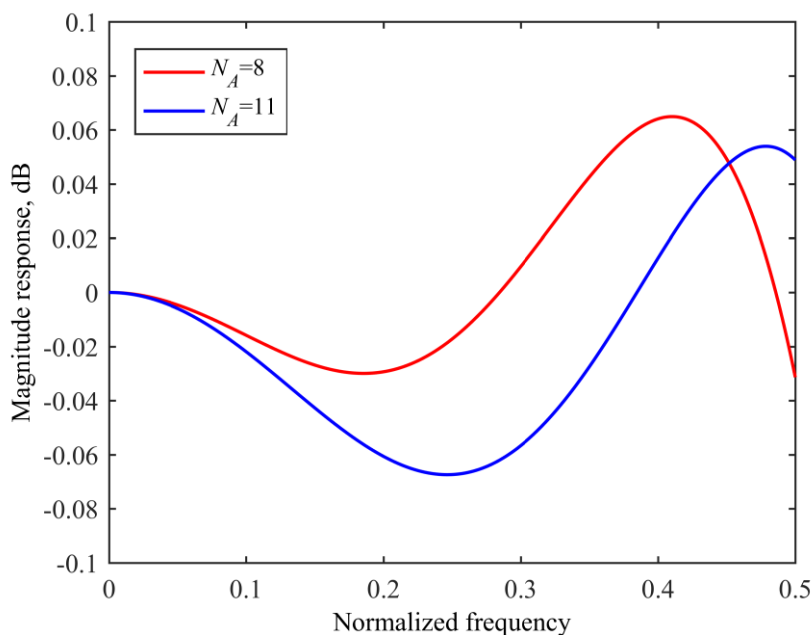

Figure 3.22 Magnitude responses of compensated CIC filter with $N=5$ and $R=32$, assuming $\omega_p = \pi/2$ and $L=5$. For compensation, proposed compensator with $P=2$ (red) and compensator in [44] (blue) are used. Both compensators ensure maximum deviation close to 0.1 dB and have N_A adders [48].

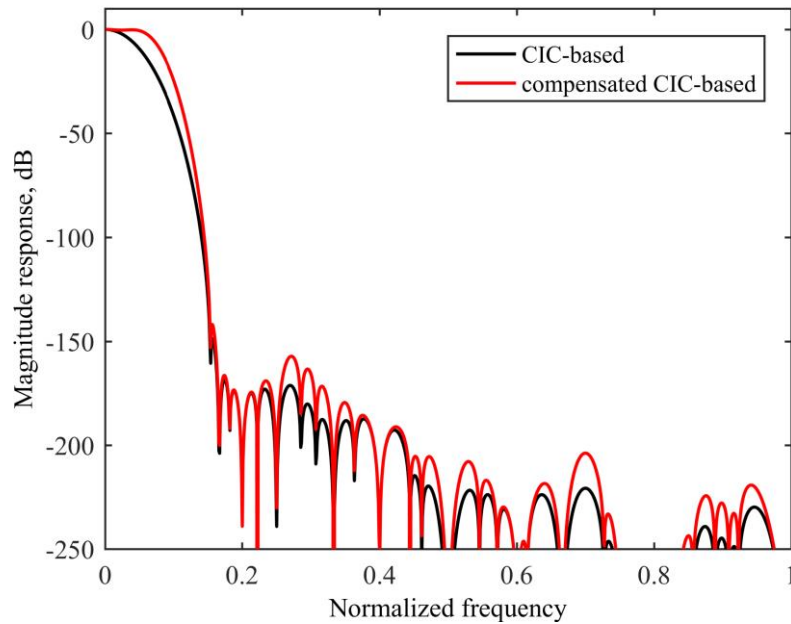

Figure 3.23 High-rate magnitude responses of original [22] and compensated CIC-based filter with $R=10$, assuming $\omega_p = \pi/2$, $L=10$ and $P=2$ [48].

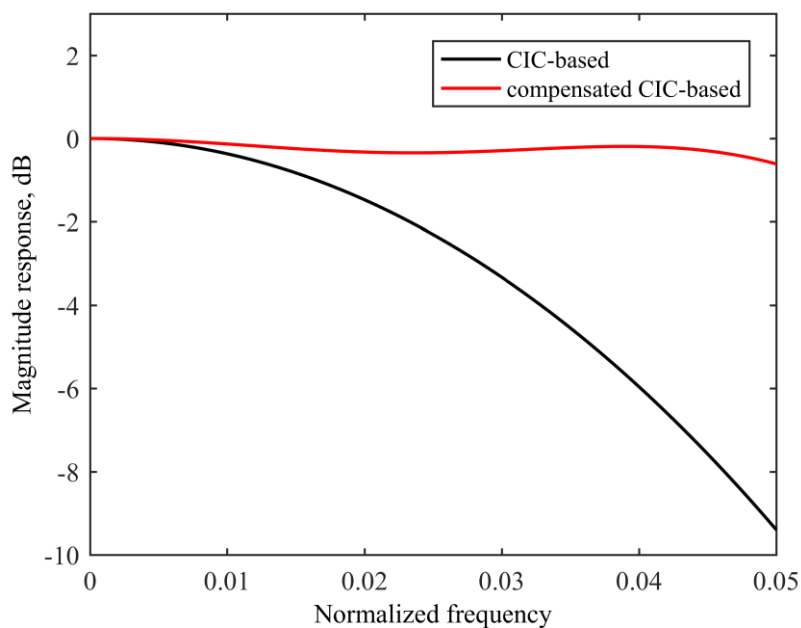

Figure 3.24 Low-rate magnitude responses of the original [22] and compensated CIC-based filter with $R = 10$, assuming $\omega_p = \pi/2$, $L = 10$ and $P = 2$ [48].

3.4.2 Compensators with non-unity gain

3.4.2.1 Objective function

All previously described compensators are designed to have unity gain. This property is usually achieved by dealing with predefined central compensator's coefficient. However, setting this coefficient free opens the possibility for further droop reduction. Consequently, such an approach introduces a floating gain into the design process.

In [49], c_0 is used as a free variable. To ensure the error function in (3.50) is independent of the compensator's gain at $\omega = 0$, the compensator response $H(\omega, \mathbf{c})$ is normalized to $H(0, \mathbf{c})$. The objective function thus takes the form

$$\varepsilon(\mathbf{c}) = \max_{\omega \in \Omega} \frac{H_C(\omega)H(\omega, \mathbf{c})}{H(0, \mathbf{c})} - \min_{\omega \in \Omega} \frac{H_C(\omega)H(\omega, \mathbf{c})}{H(0, \mathbf{c})} \quad (3.58)$$

where $\mathbf{c} = [c_0, c_1, \dots, c_{(L-1)/2}]^T$ and $\Omega = [-\omega_p, \omega_p]$ is the passband. It is clear that the normalization eliminates the coefficients which satisfy $H(0, \mathbf{c}) = 0$. The gain $H(0, \mathbf{c})$ is easily obtained as

$$H(0, \mathbf{c}) = c_0 + 2 \sum_{k=1}^{(L-1)/2} c_k \quad (3.59)$$

In the proposed design, $\varepsilon(\mathbf{c})$ is calculated using the responses evaluated on uniformly spaced frequency grid $Q = \{\omega_k, k=0, \dots, K-1\}$ defined within Ω . Hence, the objective function is obtained as

$$\varepsilon(\mathbf{c}) = \max_{\omega_k \in Q} \frac{H_C(\omega_k)H(\omega_k, \mathbf{c})}{H(0, \mathbf{c})} - \min_{\omega_k \in Q} \frac{H_C(\omega_k)H(\omega_k, \mathbf{c})}{H(0, \mathbf{c})} \quad (3.60)$$

To obtain a simple multiplierless compensator, each coefficient is represented as a signed power of two. Therefore, the optimum compensators's coefficients that provide minimum passband deviation are obtained by solving the problem

$$\begin{aligned} \hat{\mathbf{c}} &= \arg \min_{\mathbf{c}} [\varepsilon(\mathbf{c})] \\ \text{subject to: } & c_k = b_k 2^{p_k} \quad ; \quad k = 0, 1, \dots, (L-1)/2 \\ & H(0, \mathbf{c}) \neq 0 \end{aligned} \quad (3.61)$$

where $b_k \in \{-1, 1\}$ and p_k is a non-negative integer. For a given wordlength W , exponent p_k takes the value from the interval $0 \leq p_k \leq W-1$.

From (3.60) it is clear that $\varepsilon(\mathbf{c}) = \varepsilon(-\mathbf{c})$. Apparently, two global minimizers with opposite signs exist. However, the minimizer that provides positive gain is preferred. It is achieved by adding $c_0 > 0$ to the constraints in (3.61). This constraint simplifies the search because the optimization deals with only half of the overall coefficient space.

For small L and W , the problem in (3.61) is simple and it can be solved by using the exhaustive search. The exhaustive search proves fast for compensators with $L \leq 7$ and $W \leq 12$, which is sufficient for many applications. For convenience, an example of MATLAB code for calculating the coefficients is provided. The function is called *ciccomp* [49]. Its input parameters are the order of the CIC filter N , decimation factor R , a number of coefficients L , wordlength W , and passband edge frequency ω_p . The function returns the coefficients expressed as real numbers, which can be easily converted into the sums of SPT terms. In the function, the objective function is evaluated on the frequency grid with $K = 64$. To ensure $H(0, \mathbf{c})$ is close to the unity, the result of the exhaustive search is scaled by an appropriate power-of-two factor.

```
function c=ciccomp(N,R,L,W,wp)
% frequency grid
K=64;
w=linspace(0,wp,K)';

% CIC response at low rate
HC=ones(size(w));
k=(w~=0);
HC(k)=(1/R*sin(w(k)/2)./sin(w(k)/2/R)).^N;

% compensator response
HH=cos(w(:)*(0:(L-1)/2));
HH(:,2:end)=2*HH(:,2:end);

% the space of coefficients
ck=[-2.^(0:W-1),0,2.^(0:W-1)];
C=[];
for p=0:(L-1)/2
    P= repmat(ck(1:2*W+1)',1,(2*W+1)^p)';
    P=P(:);
```

```

C=[repmat(P,(2*W+1)^(L+1)/2)/length(P),1],C];
end

% exhaustive search
epsi_min=realmax;
for q=1:length(C)
c=(C(q,:))';
H=HH*c;
if H(1)~=0 && c(1)>0
epsi=max(HC.*H/H(1)-min(HC.*H/H(1)));
if epsi<epsi_min
epsi_min=epsi;
c_kappa=c';
end
end
end

% calculation of the gain closest the unity
h=[fliplr(c_kappa(2:end)),c_kappa];
gain_offset=zeros(1,2*W+1);
for k=-W:W
gain_offset(k+W+1)=abs(1/sum(2^k*h)-1);
end
ind=find(gain_offset==min(gain_offset));

% the optimum coefficients
c=2^((ind-W)-1)*c_kappa;

```

3.4.2.2 Adder cost

The compensators with non-unity gain are realized using the direct form shown in Figure 3.3. Since the compensator coefficients are realized using signed-power-of-two constant multipliers, the total number of adders required in the structure is given by

$$N_A = L - 1 \quad (3.62)$$

3.4.2.3 Design examples

The features of the proposed method are illustrated with the design of several wideband compensators. The compensators with $L = 3, 5,$ and 7 coefficients for the CIC filters of various orders and decimation factors are considered. The coefficients are obtained for $W = 12$.

Example 1. Narrowband design is illustrated with compensation of the CIC filter with $N = 4$ and $R = 32$ by using the compensators with three coefficients. The passband edge frequency $\omega_p = \pi/4$ is chosen. The optimum coefficients are obtained as $\mathbf{c} = [1, -2^{-3}]$. Figure 3.25 shows the compensated passband response together with the response obtained by the sine-based compensator proposed in [39]. The proposed response is normalized to the gain at $\omega = 0$,

which is equal to -2.50 dB. The CIC filter introduces the droop of 0.90 dB. The compensator in [39] provides the deviation of 0.28 dB by using three adders. However, the proposed compensator yields the deviation of 0.09 dB by employing two adders only.

Example 2. Nowadays, multiplierless compensators with five coefficients are often required since they significantly improve wide passbands. Hence, the proposed compensator with $L = 5$ is compared with the compensators recently proposed in [43] and [48]. For illustration, the CIC filter with $N = 6$ and $R = 32$ is improved, assuming $\omega_p = \pi/2$. The optimum coefficients are obtained as $\mathbf{c} = [2, -2^{-1}, 2^{-5}]$. Figure 3.26 shows the obtained passband responses. The response of the proposed compensator is normalized to the gain at $\omega = 0$, which equals 0.53 dB. The uncompensated CIC filter has the droop of 5.47 dB. The proposed compensator yields the deviation of 0.66 dB by employing four adders only. The deviations obtained by the compensators from [43] and [48] are 0.12 dB and 0.57 dB. However, their somewhat lower deviations are paid by increasing the total number of adders by six and two, respectively.

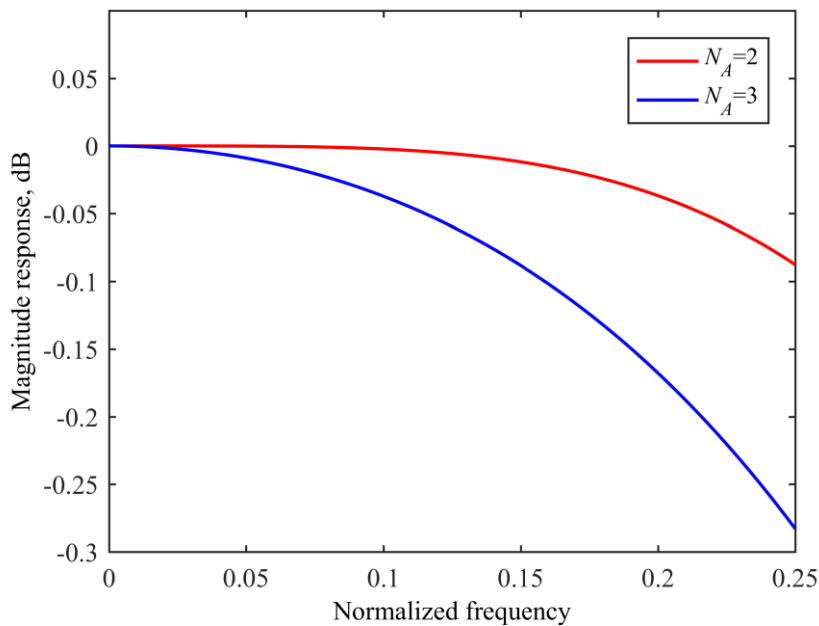

Figure 3.25 Magnitude responses of compensated CIC with $N = 4$ and $R = 32$, assuming $\omega_p = \pi/4$ and $L = 3$. For compensation, proposed compensator (red) and compensators in [39] (blue) are used. All compensator have N_A adders [49].

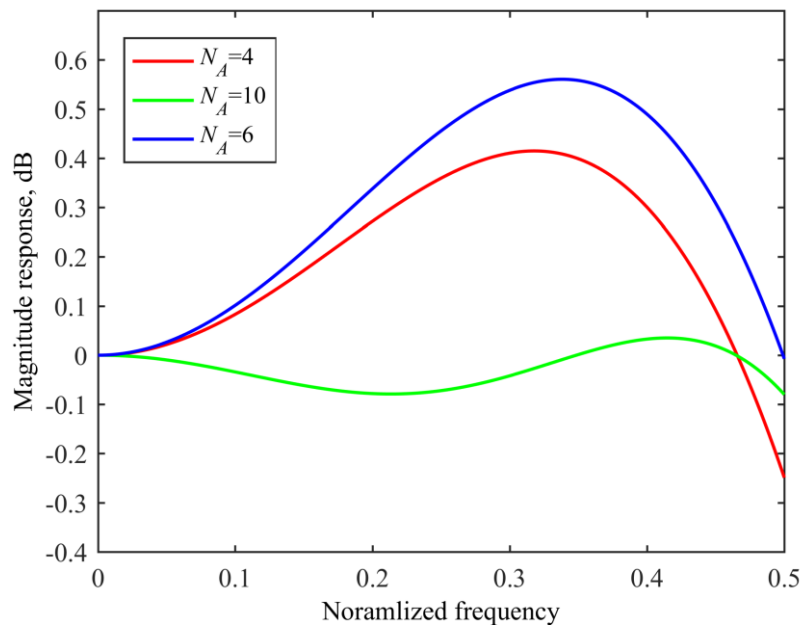

Figure 3.26 Magnitude responses of compensated CIC filter with $N=6$ and $R=32$, assuming $\omega_p = \pi/2$ and $L=5$. For compensation, proposed compensator (red) and compensators in [43] (green) and [48] (blue) are used. All compensator have N_A adders [49].

Example 3. A two-stage multiplierless compensator that consists of one compensator with three and one compensator with five coefficients has been recently proposed in [44]. From the transfer-function point of view, this cascade corresponds to a compensator with seven coefficients. Hence, the proposed single-stage compensator with $L=7$ is compared with the two-stage compensator from [44]. The same CIC response as in the previous example is improved. The optimum compensator coefficients are obtained as $\mathbf{c} = [2, -2^{-1}, 2^{-7}, 2^{-5}]$. Figure 3.27 shows the compensated responses. The compensator in [44] ensures the deviation of 0.10 dB by employing ten adders. The proposed compensator is shown normalized to the gain of 0.65 dB. It provides the deviation of 0.27 dB by using six adders.

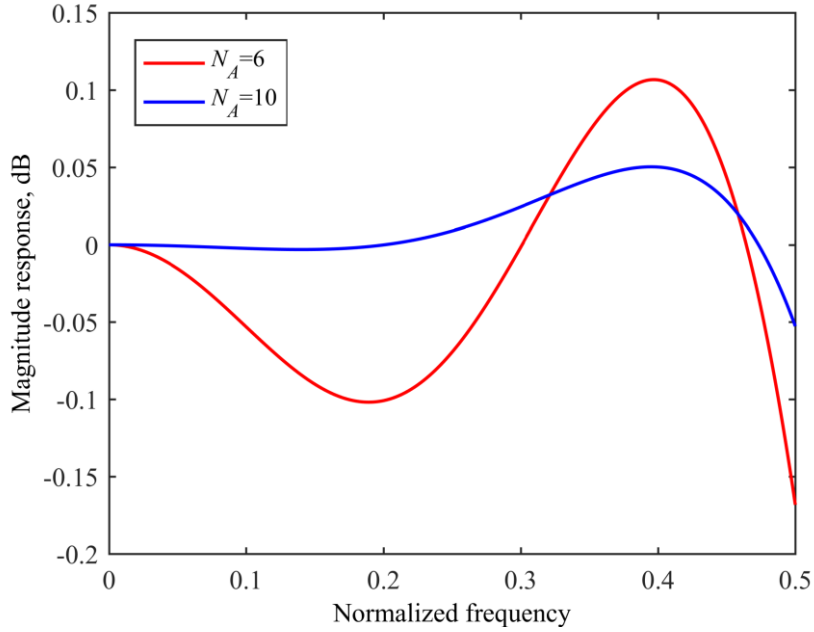

Figure 3.27 Magnitude responses of compensated CIC filter with $N=6$ and $R=32$, assuming $\omega_p = \pi/2$. For compensation, proposed compensator (red) and compensators in [44] (blue) are used. All compensator have N_A adders [49].

Example 4. The proposed compensators can also be used to improve the passband of CIC-based decimation filters [23]. Here, the compensator with seven coefficients is used to improve the filter in [23], obtained by $S=1$ and $R=10$. The passband with $\omega_p = 2\pi/5$ is chosen. The obtained coefficients are $\mathbf{c} = [2, -2^{-1}, -2^{-4}, 2^{-4}]$, providing the unity gain at $\omega = 0$. Figure 3.28 shows the original and compensated magnitude responses relative to the high sampling rate. Figure 3.29 shows the corresponding responses relative to the low sampling rate. The original filter introduces the droop of 4.76 dB. The proposed compensation significantly improves the passband, resulting in the deviation of 0.24 dB and the structure of six adders.

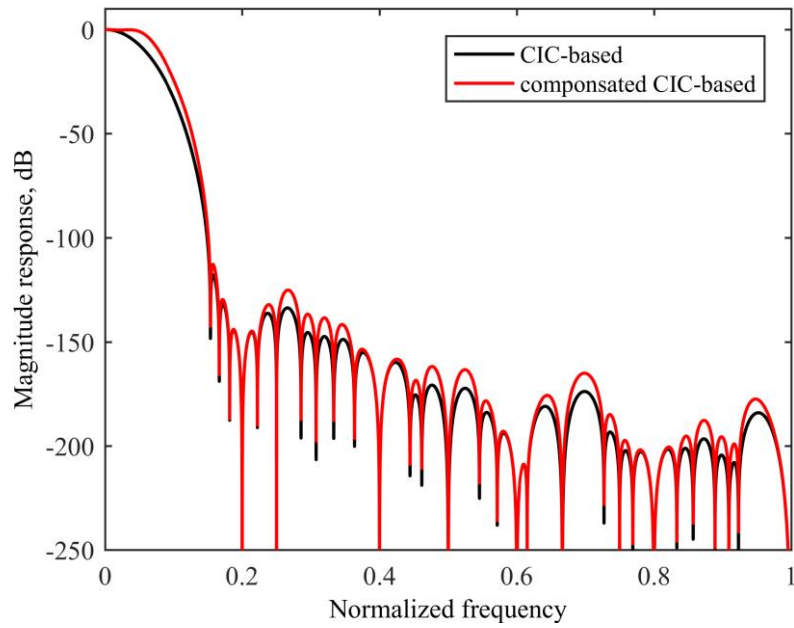

Figure 3.28 High-rate magnitude responses of original [23] and compensated CIC-based filter with $R = 10$, assuming $\omega_p = 2\pi/5$ and $L = 7$ [49].

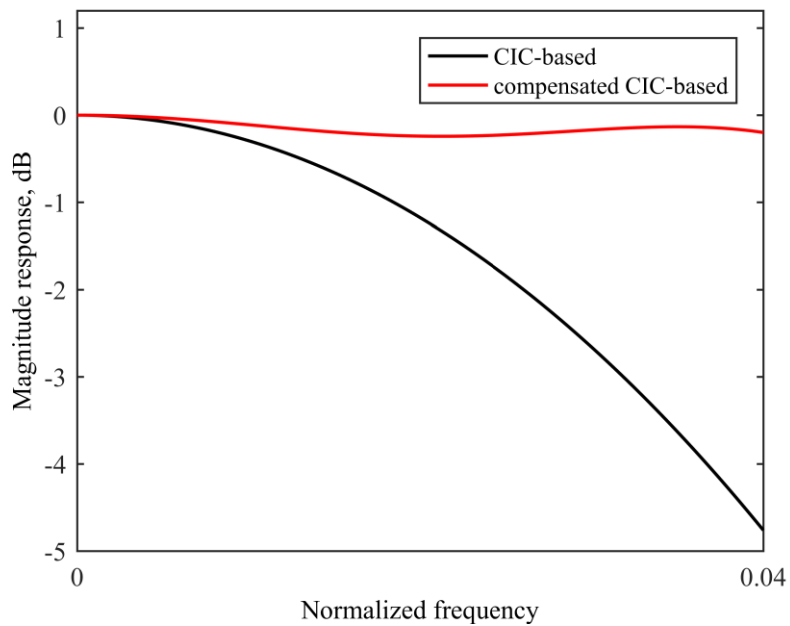

Figure 3.29 Low-rate magnitude responses of original [23] and compensated CIC-based filter with $R = 10$, assuming $\omega_p = 2\pi/5$ and $L = 7$ [49].

4. SHARPENED CASCADED-INTEGRATOR-COMB FILTERS

4.1 Polynomial sharpening

In the processing of wideband signals, the CIC filter is often incapable of meeting the requirement for high folding-band attenuations. To improve the CIC-filter folding-band response, various structures have been developed. An efficient structure arises from the polynomial sharpening of CIC response [54]. This structure implements a so-called sharpened CIC (SCIC) filter.

The design of sharpened CIC filters is based on searching the polynomial coefficients ensuring required magnitude response. Several design methods have been developed, resulting in real, integer, and sum-of-powers-of-two (SPT) coefficients. The latter are preferable since they result in multiplierless structures.

Well-established sharpening method was developed by Kaiser and Hamming [55]. It gives integer coefficients using the analytic expression. The incorporation of the Kaiser-Hamming polynomial in SCIC filter was first presented in [56]. This structure is further improved in [57]–[60]. Recently, the Chebyshev polynomials have been used in the design of SCIC filters with very high folding-band attenuations [61]. Furthermore, closed-form methods for the design of SCIC filters using the weighted least-squares [62] and minimax [63] error criterion in the passband and folding-bands have been proposed. These methods provide SCIC filters ensuring small passband deviations and rather high folding-band attenuations. However, the coefficients obtained take real values, which results in the structure employing multipliers. In [64], the particle swarm optimization has been used to calculate SPT polynomial coefficients in order to achieve a given passband deviation. In [65], partially sharpened CIC filters have been developed, employing the polynomials in Bernstein's form [66], [67]. The proposed filters are multiplierless, but they only support power-of-two decimation factors. In [68] and [69], the sharpening has been combined with passband compensation.

4.2 Transfer function

The sharpening polynomial of the M th order is given by

$$f(x) = \sum_{m=0}^M a_m x^m \quad (4.1)$$

The amplitude response of the SCIC filter is obtained by substituting $x = H_{CIC}(\omega)$ into (4.1). It is given by

$$H_{SCIC}(\omega) = \sum_{m=0}^M a_m H_{CIC}^m(\omega) \quad (4.2)$$

In implementing the CIC filter, the input sampling rate is maximized by adding an extra delay term in each integrator stage, as in

$$H_{CIC}(z) = \frac{1}{R^N} \left(z^{-1} \frac{1-z^{-R}}{1-z^{-1}} \right)^N = \frac{1}{R^N} I^N(z) C^N(z^R) \quad (4.3)$$

where

$$I(z) = \frac{z^{-1}}{1-z^{-1}} \quad (4.4)$$

and

$$C(z) = 1 - z^{-1} \quad (4.5)$$

The extra delay in (4.3) allows the realization of the integrators in (4.4) which deliver the data from the delay elements rather than from the adders [63].

The phase of the filter in (4.3) is $\theta(\omega) = -\omega D$, where $D = N(R+1)/2$. Thus, the phase of the CIC filter sharpened with M th order polynomial is $\varphi(\omega) = M\theta(\omega)$. By adding the phase $\varphi(\omega)$ to (4.2), the frequency response of the SCIC filter is obtained as

$$H_{SCIC}(\omega) e^{jM\theta(\omega)} = \sum_{m=0}^M a_m H_{CIC}^m(\omega) e^{jm\theta(\omega)} e^{j(M-m)\theta(\omega)} \quad (4.6)$$

The transfer function of the SCIC filter is easily obtained from (4.6) as

$$H_{SCIC}(z) = \sum_{m=0}^M a_m H_{CIC}^m(z) z^{-(M-m)D} \quad (4.7)$$

It is well known that the amplitude response of the original CIC filter has zeros placed at the central frequencies of the folding-bands. Such a placement of zeros is convenient since it eliminates DC component caused by the aliases. In sharpened CIC filter, these zeros are kept if $a_0 = 0$. Therefore, the amplitude response takes the form

$$H_{SCIC}(\omega) = \sum_{m=1}^M a_m H_{CIC}^m(\omega) \quad (4.8)$$

The corresponding transfer function is given by

$$H_{SCIC}(z) = \sum_{m=1}^M a_m H_{CIC}^m(z) z^{-(M-m)D} \quad (4.9)$$

To illustrate the sharpening technique, the amplitude response of the second-order CIC filter with $R = 10$ is improved with $f(x) = 3x^2 - 2x^3$ [55]. Figure 4.1 shows the amplitude responses of the sharpened filter and the original CIC filter. It is clear that this polynomial simultaneously improves passband and folding-bands. Figure 4.2 shows the impulse responses of the sharpened and the original filter. Since this sharpening improves filter's selectivity, the obtained filter has the impulse response with ringing.

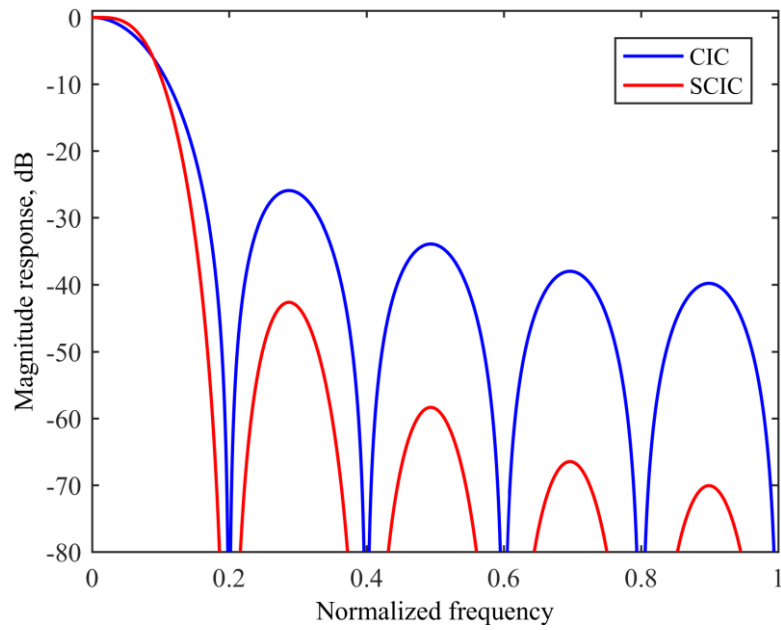

Figure 4.1 Magnitude responses of original CIC filter with $N=2$ and $R=10$ and CIC filter sharpened with $f(x) = 3x^2 - 2x^3$.

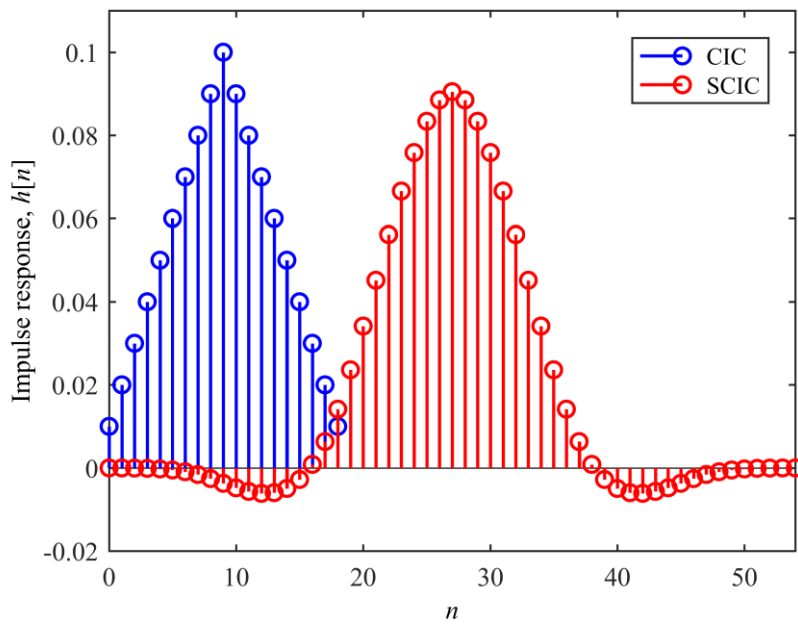

Figure 4.2 Impulse responses of CIC filter with $N=2$ and $R=10$ and CIC filter sharpened with $f(x) = 3x^2 - 2x^3$.

4.3 Structure of sharpened CIC filter

The Saramaki-Ritoniemi structure of the sharpened CIC filter is shown in Figure 4.3 [54]. It is clear that one constant multiplier is necessary for each polynomial coefficient. In addition, if a high-order polynomial with real coefficients is employed, the structure becomes very complex. However, by using the polynomial coefficients expressed as SPT, the multiplierless SCIC structure is obtained. The adder cost of such a structure is given by

$$N_A = 2NM + M - 1 + \sum_{k=0}^M N_A(a_k) \quad (4.10)$$

where $N_A(a_k)$ is the number of adders needed for the multiplication with a_k .

It should be noted that the structure in Figure 4.3 is suitable if the delay elements introduce integer delays. It is achieved if $N(R+1)$ is an even number. The structure can be further simplified such that elements with delays greater than R are split into two blocks by applying the noble identity. Consequently, one element operates at high, whereas the other one operates at a low sampling rate.

4.4 Sharpening polynomials

Two approaches to the design of sharpened CIC filters have been considered in the literature. The first approach *simultaneously sharpens passband and folding-band response*. The sharpening polynomial is obtained using the maximally flat [55], [67], least-squares [62], or minimax [63] approximation. The second approach *considers sharpening only within the folding-bands*. Such an approach includes the design based on the Chebyshev polynomials [61]. For high folding-band attenuations, the second approach is preferable.

In the following sections, common polynomials suitable for the design of multiplierless sharpened CIC filters are described in detail.

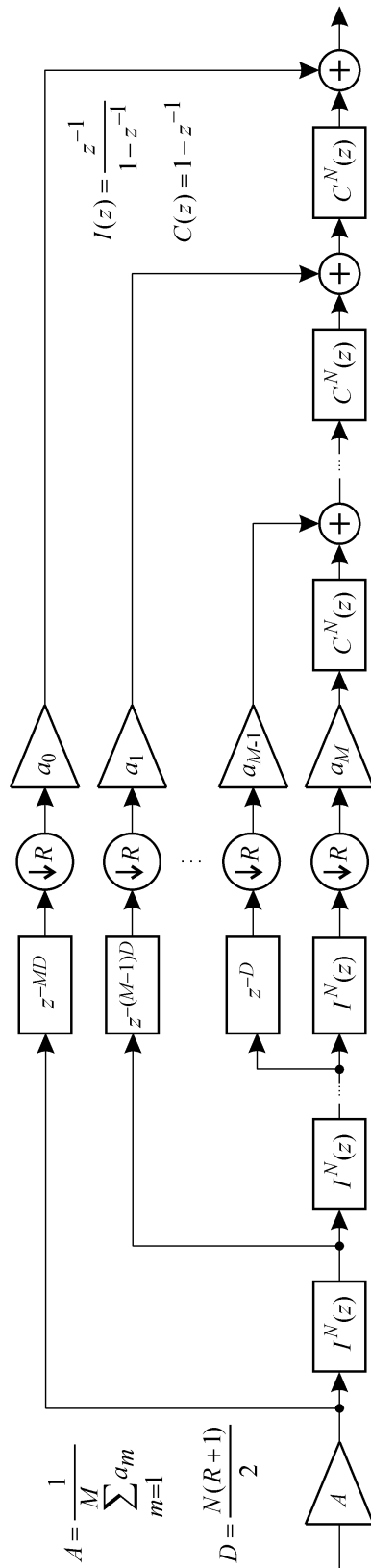

Figure 4.3 Realization of sharpened CIC filter [54].

4.4.1 Maximally flat sharpening

4.4.1.1 Kaiser-Hamming polynomial

In [55], Kaiser and Hamming proposed sharpening polynomial based on maximally flat conditions. They constructed the polynomial which has a p th-order tangency at $x = 1$, q th-order tangency at $x = 0$, and passes through the points $(1, 1)$ and $(0, 0)$. These conditions are formulated in Table 4.1. The polynomial satisfying these conditions is given by the Bernstein form

$$f_{p,q}(x) = x^{q+1} \sum_{r=0}^p \frac{(q+r)!}{q!r!} (1-x)^r \quad (4.11)$$

where $p + q = M - 1$, and p and q are positive integers. The choice of p and q depends on the application at hand. To obtain the SCIC filters with low passband droop, p should be large. On the other hand, to obtain the filters with high folding-band attenuations, q should be large. In particular, $p = 0$ and $q = M - 1$ bring the SCIC filters obtained by the sharpening within the folding-bands only.

Table 4.1 Maximally flat conditions to sharpening polynomial [55].

$x = 1$	$x = 0$
$f(1) = 1$	$f(0) = 0$
$f^{(1)}(1) = 0$	$f^{(1)}(0) = 0$
\vdots	\vdots
$f^{(p)}(1) = 0$	$f^{(q)}(0) = 0$

For $p = 0$ and $q = M - 1$, the Kaiser-Hamming polynomial takes the form $f_{0,M-1}(x) = x^M$. Such a polynomial applied to the N th-order CIC filter results in the CIC filter of order NM . Therefore, the CIC filter of order MN is actually the Kaiser-Hamming SCIC filter obtained by the folding-band sharpening of N -th order CIC response.

The third-order Kaiser-Hamming polynomials having $p + q = 2$ are shown in Figure 4.4. The sharpened responses obtained by applying these polynomials to the CIC response with $N = 2$ and $R = 10$ are shown in Figure 4.5. It is clear from the figures that folding-band attenuation is increased by an increase in q . As expected, the maximum attenuation is achieved for $p = 0$ and $q = 2$.

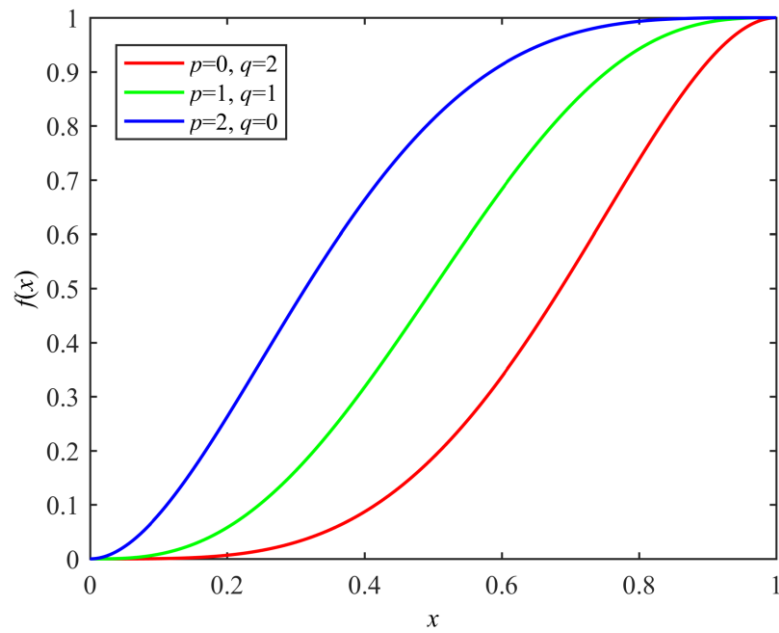

Figure 4.4 Third-order Kaiser-Hamming polynomials having $p + q = 2$ [55].

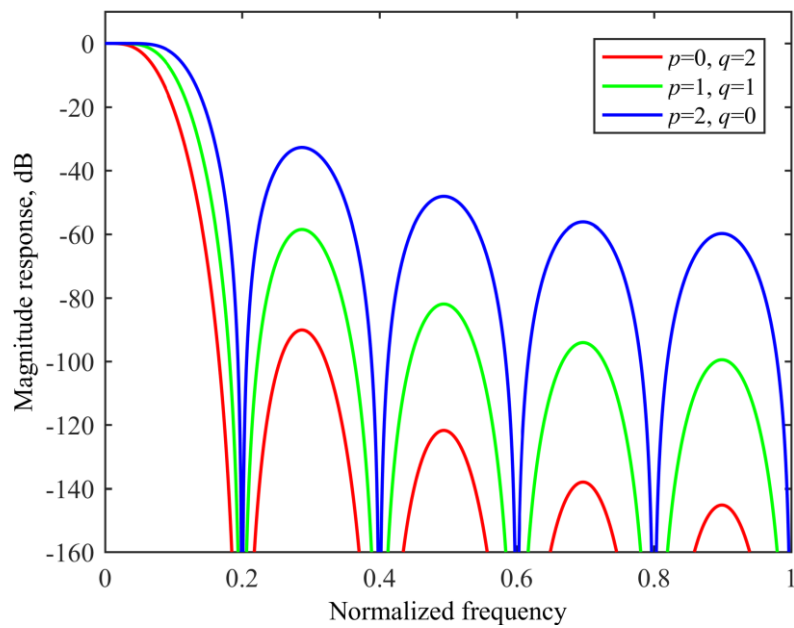

Figure 4.5 Magnitude responses of CIC filter with $N=2$ and $R=10$ sharpened with third-order Kaiser-Hamming polynomials having $p + q = 2$ [55].

4.4.1.2 Generalized Kaiser-Hamming polynomial

A generalization of the Kaiser-Hamming polynomial was proposed by Samadi in [67]. In the paper referred to, Samadi constructed the polynomial having a p th-order tangency to the line $y = 1 - \sigma(1 - x)$ at $x = 1$ and q th-order tangency to the line $y = \delta x$ at $x = 0$. The Samadi polynomial is given by

$$f_{p,q,\sigma,\delta}(x) = \delta x + \sum_{m=q+1}^M (b_{m,0} - \sigma b_{m,1} - \delta b_{m,2})x^m \quad (4.12)$$

where

$$b_{m,0} = b_{m,1} + b_{m,2} \quad (4.13)$$

$$b_{m,1} = \sum_{n=q+1}^m (-1)^{m-n} \binom{M}{m} \binom{m}{n} \left(1 - \frac{n}{M}\right) \quad (4.14)$$

$$b_{m,2} = \sum_{n=q+1}^m (-1)^{m-n} \binom{M}{m} \binom{m}{n} \frac{n}{M} \quad (4.15)$$

In this generalization, the Kaiser-Hamming polynomial is obtained by setting $\sigma = 0$ and $\delta = 0$.

The Samadi polynomials have real coefficients. However, in [65] the multiplierless SCIC structure is obtained by setting $\delta = 0$, $p = 1$, and by rounding σ to the power of two.

4.4.2 Chebyshev sharpening

In [61], Coleman proposed folding-band sharpening based on Chebyshev polynomials of the first kind. An n th-order Chebyshev polynomial of the first kind is defined by the recurrence relation

$$f_n(x) = \begin{cases} 1 & ; n = 0 \\ x & ; n = 1 \\ 2xf_{n-1}(x) - f_{n-2}(x) & ; n > 1 \end{cases} \quad (4.16)$$

The Chebyshev polynomials of an even order contain even powers only. Therefore, sharpening of the first-order CIC filter with even-order polynomials can be considered as sharpening of the second-order CIC filter. Furthermore, to control passband edge frequency

ω_p and, consequently, the widths of folding-bands, Coleman deals the CIC response normalized with γR , where γ determines ω_p . The maximum value of γ is given by

$$\gamma_{\max} = \frac{1}{R \cdot H_{CIC} \left(\frac{2\pi - \omega_p}{R} \right)} \quad (4.17)$$

Coleman incorporated the normalization into the Chebyshev polynomial in (4.16), resulting in sharpening polynomial

$$f(x) = f_{2M}(\gamma R \cdot u) \Big|_{u^2=x} \quad (4.18)$$

The coefficients of the polynomial in (4.18) can be expressed as SPT only for specific values of γ . In opposite, they take real values, thus requiring general purpose multipliers in SCIC structure. Furthermore, Coleman proposed an efficient realization of the SCIC filter where additional constant multiplier, b_i , is added in cascade with each comb filter $C^N(z)$ in Figure 4.3. Apparently, coefficients b_i can be folded back into the branch with coefficients a_i . However, the separation of coefficients often results in a simpler realization. For illustration, using (4.18), the third-order polynomial has the form

$$f(x) = -1 + 18\gamma^2 R^2 x - 48\gamma^4 R^4 x^2 + 32\gamma^6 R^6 x^3 \quad (4.19)$$

This polynomial is further factorized by using the Horner algorithm, resulting in

$$f(x) = -1 + 2\gamma^2 R^2 x \left[\begin{array}{ccc} 9 + 8\gamma^2 R^2 x & (-3 + 2\gamma^2 R^2 x) & \\ a_1 & b_1 & a_2 & b_2 \end{array} \right] \quad (4.20)$$

The coefficients b_i and a_i are thus obtained straightforward. The multiplierless realization of b_i is ensured by setting $\gamma^2 = \eta 2^{-l}$, where η and l are integers.

For illustration, the CIC filter with $N=2$ and $R=10$ is sharpened with previously described polynomial. To obtain a simple structure, $\eta=3$ is chosen. Furthermore, parameter l is chosen to ensure passband edge frequencies $\omega_p \approx 0.3\pi$, 0.4π , and 0.5π . Therefore, simple multiplierless Chebyshev SCIC filters are designed, resulting in

$$\omega_p = \begin{cases} 0.29\pi & , \gamma^2 = 3 \cdot 2^{-2} \\ 0.39\pi & , \gamma^2 = 3 \cdot 2^{-3} \\ 0.49\pi & , \gamma^2 = 3 \cdot 2^{-4} \end{cases} \quad (4.21)$$

Figure 4.6 shows the magnitude responses of the obtained sharpened filters. It is clear that these filters exhibit very high folding-band attenuations. In addition, each filter requires only 17 adders.

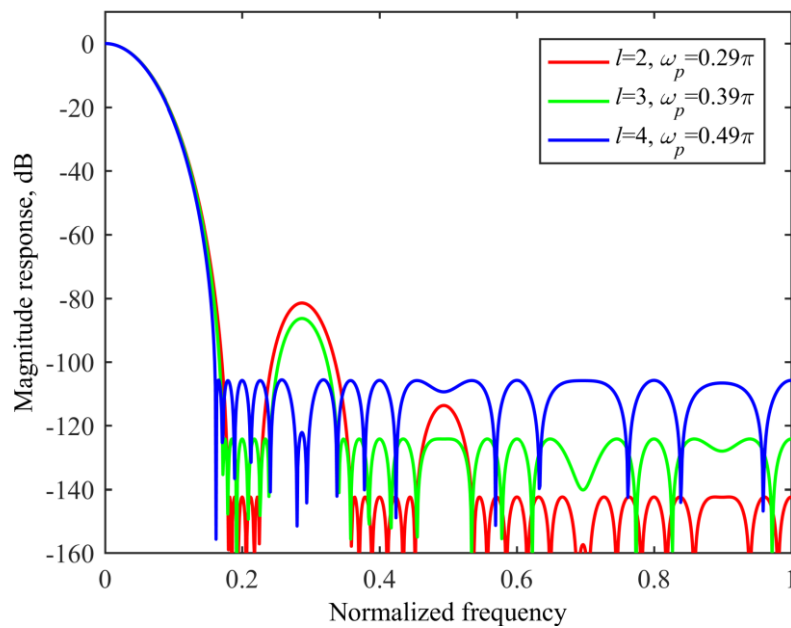

Figure 4.6 Magnitude responses of SCIC filter with $N = 2$ and $R = 10$, obtained by third-order Chebyshev polynomials having $\eta = 3$ and $l = 2, 3$, and 4 [61].

4.5 Minimax sharpened CIC filter

4.5.1 Objective function

Chebyshev sharpening results in very high alias rejection. However, it has multiplierless structures only for particular values of passband edge frequencies. To obtain multiplierless SCIC filters exhibiting similar folding-band behavior, an optimization-based design using the minimax sharpening of the folding-bands over the SPT polynomial coefficient space is developed [76]. To obtain these filters, the error function is defined as in

$$\varepsilon(\mathbf{a}) = \max_{\omega \in \Omega} w(\omega) |H_{SCIC}(\omega, \mathbf{a}) - H_d(\omega)| \quad (4.22)$$

where $\mathbf{a} = [a_1 \ a_2 \ \cdots \ a_M]^T$ is the vector of the polynomial coefficients, $w(\omega)$ is the positive weighting function, and $H_d(\omega)$ is the desired amplitude response defined within the band Ω . The error function in (4.22) should take into account only the folding-bands. They are given by

$$\Omega = \begin{cases} \frac{2n\pi - \omega_p}{R} \leq \omega \leq \frac{2n\pi + \omega_p}{R} & ; \quad n = 1, \dots, \frac{R}{2} - 1 \\ \pi - \frac{\omega_p}{R} \leq \omega \leq \pi \end{cases} \quad (4.23)$$

for an even R , and by

$$\Omega = \frac{2n\pi - \omega_p}{R} \leq \omega \leq \frac{2n\pi + \omega_p}{R} & ; \quad n = 1, \dots, \frac{R-1}{2} \quad (4.24)$$

for an odd R , where ω_p is passband edge frequency relative to the low sampling rate. In the folding-bands, the desired response is zero. In addition, the unity weighting function is assumed. By substituting $H_d(\omega) = 0$ and $w(\omega) = 1$ into (4.22), the error function is obtained as

$$\varepsilon(\mathbf{a}) = \max_{\omega \in \Omega} |H_{SCIC}(\omega, \mathbf{a})| \quad (4.25)$$

Note that function in (4.25) does not consider filter's passband gain. Therefore, the SCIC amplitude response is normalized to constant passband gain at one frequency. Here, the unity gain at $\omega = 0$ is chosen. The error function thus takes the form of relative folding-band attenuation, as in

$$\varepsilon(\mathbf{a}) = \max_{\omega \in \Omega} \left| \frac{H_{SCIC}(\omega, \mathbf{a})}{H_{SCIC}(0, \mathbf{a})} \right| \quad (4.26)$$

The expression for $H_{SCIC}(0, \mathbf{a})$ is easily obtained by substituting $\omega = 0$ into (4.3), resulting in

$$H_{SCIC}(0, \mathbf{a}) = \sum_{m=1}^M a_m \quad (4.27)$$

Finally, by substituting (4.27) into (4.26), the error function is obtained as

$$\varepsilon(\mathbf{a}) = \max_{\omega \in \Omega} \left| \frac{\sum_{m=1}^M a_m H_{CIC}^m(\omega)}{\sum_{m=1}^M a_m} \right| \quad (4.28)$$

In the proposed design, $\varepsilon(\mathbf{a})$ is calculated using the responses evaluated on uniformly spaced frequency grid $Q = \{\omega_k, k=0, \dots, K-1\}$ defined within Ω . Hence, the objective function is obtained as

$$\varepsilon(\mathbf{a}) = \max_{\omega_k \in Q} \left| \frac{\sum_{m=1}^M a_m H_{CIC}^m(\omega_k)}{\sum_{m=1}^M a_m} \right| \quad (4.29)$$

To obtain simple multiplierless sharpened CIC filters, each polynomial coefficient is expressed as sum of the SPT terms. Furthermore, the total number of SPT terms is restricted to a specified value, P . To obtain the optimum SPT coefficients of the SCIC filter in the minimax sense, the design is described by the optimization problem

$$\begin{aligned} \hat{\mathbf{a}} &= \arg \min [\varepsilon(\mathbf{a})] \\ \text{subject to: } a_k &= \sum_{p=0}^{W-1} b_{k,p} 2^{-p} \quad ; \quad k = 1, 2, \dots, M \\ &\sum_{p=0}^{W-1} |b_{k,p}| = P \quad ; \quad k = 1, 2, \dots, M \end{aligned} \quad (4.30)$$

where $b_{k,p} \in \{-1, 0, 1\}$ and W is the wordlength of coefficients. From (4.29) it is clear that $\varepsilon(\mathbf{a}) = \varepsilon(-\mathbf{a})$. Apparently, two global minimizers with opposite signs exist. However, the minimizer that provides a positive gain of the filter is preferred. It is achieved by adding the constraint $H_{SCIC}(0, \mathbf{a}) > 0$ to the objective function. It simplifies the search because the optimization deals with only half of the overall SPT coefficient space. To obtain the optimum SPT coefficients, a global optimization technique based on the interval analysis is used. The optimization procedure is given in Section 3.4.1.2.

4.5.2 Adder cost

The minimax SCIC filter is realized using the Saramaki and Ritonieni structure [54], which is shown in Figure 4.3. It is clear that filter's computational complexity depends on the implementations of constant multipliers. Since each SPT coefficient requires $P-1$ adders, the total number of adders in the structure is given by

$$N_A = 2NM + MP - 1 \quad (4.31)$$

Note, for $P = 1$, the coefficients are realized only by using shifts.

4.5.3 Design examples

The design of SCIC filters is performed for the CIC filters with decimation factor $R = 10$ by using $K = 900$ frequency points. The optimum SPT coefficients are found for $W = 20$. The obtained coefficients are given in Table 4.2. They are tabulated for various passband edge frequencies and SCIC filter orders. It is well known that for a given order of the CIC filter, the amplitude response negligibly changes the shape within the passband and folding-bands for $R \geq 10$. In that sense, the tabulated SPT coefficients can be used for sharpening of any CIC filter with $R \geq 10$ [3].

Example 1. Simple SCIC filters are illustrated with the sharpening of the CIC response with $N = 2$ and $R = 10$, by using the polynomial with $M = 3$ and $P = 1$, and the passband edge frequencies given in Table 4.2. Figure 4.7 shows the magnitude responses of the SCIC filters obtained for $\omega_p = 0.2\pi$ and $\omega_p = 0.5\pi$. The filter with $\omega_p = 0.2\pi$ ensures the minimum folding-band attenuation of 132 dB, whereas the filter with $\omega_p = 0.5\pi$ exhibits the minimum attenuation of 81 dB and, as expected, higher passband droop. Other simple SCIC filters have the passband and folding-band responses placed somewhere between the described responses. From Table 4.2, it is clear that minimax SCIC filters exhibit rather high folding-band attenuations. However, they have structures in which three general-purpose multipliers are replaced by only one adder. In addition, they have similar responses within $|\omega| \leq 0.5\pi/R$, what makes them suitable for uniform passband compensation.

Table 4.2 SPT polynomial coefficients, passband droop (δ), and minimum folding-band attenuation (δ_s) of various minimax sharpened CIC filters with $N=2$ and $R \geq 10$ [76].

M=3											
a_m	$\omega_p=0.2\pi$		$\omega_p=0.25\pi$		$\omega_p=\pi/3$		$\omega_p=0.4\pi$		$\omega_p=0.5\pi$		
	$P=1$	$P=2$	$P=1$	$P=2$	$P=1$	$P=2$	$P=1$	$P=2$	$P=1$	$P=2$	
a_1	2^{-14}	$2^{-14}+2^{-19}$	2^{-12}	$2^{-12}-2^{-14}$	2^{-10}	$2^{-10}-2^{-12}$	2^{-11}	$2^{-9}+2^{-14}$	2^{-8}	$2^{-8}-2^{-12}$	
a_2	-2^{-6}	$-2^{-6}-2^{-10}$	-2^{-5}	$-2^{-5}+2^{-11}$	-2^{-4}	$-2^{-4}-2^{-9}$	-2^{-4}	$-2^{-3}+2^{-7}$	-2^{-3}	$-2^{-3}-2^{-8}$	
a_3	2^0	2^0-2^{-5}	2^0	2^0+2^{-3}	2^0	2^0+2^{-2}	2^0	2^1-2^{-1}	2^0	2^0+2^{-7}	
δ , dB	0.86	0.86	1.35	1.35	2.43	2.42	3.52	3.54	5.69	5.70	
δ_s , dB	132	142	125	129	106	113	94.9	102	81.0	89.3	
M=4											
a_m	$\omega_p=\pi/3$		$\omega_p=0.4\pi$		$\omega_p=0.5\pi$		$\omega_p=0.6\pi$		$\omega_p=2\pi/3$		
	$P=1$	$P=2$	$P=1$	$P=2$	$P=1$	$P=2$	$P=1$	$P=2$	$P=1$	$P=2$	
a_1	0	$-2^{-16}+2^{-19}$	2^{-15}	$-2^{-15}-2^{-17}$	2^{-13}	$-2^{-12}+2^{-18}$	-2^{-14}	$-2^{-11}-2^{-14}$	-2^{-12}	$-2^{-9}+2^{-14}$	
a_2	2^{-10}	$2^{-9}-2^{-14}$	-2^{-14}	$2^{-8}+2^{-14}$	2^{-9}	$2^{-6}+2^{-10}$	2^{-6}	$2^{-5}-2^{-7}$	2^{-6}	$2^{-4}+2^{-10}$	
a_3	-2^{-4}	$-2^{-4}-2^{-6}$	-2^{-4}	$-2^{-3}+2^{-8}$	-2^{-3}	$-2^{-2}-2^{-4}$	-2^{-2}	$-2^{-2}-2^{-5}$	-2^{-2}	$-2^{-1}-2^{-3}$	
a_4	2^0	2^0+2^{-8}	2^0	2^0+2^{-3}	2^0	2^1-2^{-2}	2^0	2^0+2^{-6}	2^0	2^1-2^{-3}	
δ , dB	3.23	3.24	4.67	4.73	7.50	7.62	11.4	11.5	14.3	14.7	
δ_s , dB	144	150	128	139	110	120	96.4	105	87.7	97.6	
M=5											
a_m	$\omega_p=0.5\pi$		$\omega_p=0.6\pi$		$\omega_p=2\pi/3$		$\omega_p=0.75\pi$		$\omega_p=0.8\pi$		
	$P=1$	$P=2$	$P=1$	$P=2$	$P=1$	$P=2$	$P=1$	$P=2$	$P=1$	$P=2$	
a_1	-2^{-18}	2^{-18}	-2^{-16}	2^{-14}	-2^{-14}	$2^{-13}+2^{-18}$	2^{-12}	$2^{-11}-2^{-13}$	-2^{-10}	$2^{-12}-2^{-17}$	
a_2	2^{-12}	$-2^{-11}+2^{-17}$	2^{-13}	-2^{-8}	2^{-9}	$-2^{-7}+2^{-12}$	2^{-11}	$-2^{-6}+2^{-10}$	2^{-8}	$-2^{-6}-2^{-10}$	
a_3	2^{-10}	$2^{-6}+2^{-10}$	2^{-6}	$2^{-4}+2^{-6}$	2^{-8}	$2^{-3}+2^{-6}$	-2^{-13}	$2^{-2}-2^{-4}$	2^{-3}	$2^{-2}-2^{-7}$	
a_4	-2^{-3}	$-2^{-2}+2^{-5}$	-2^{-2}	$-2^{-1}-2^{-3}$	-2^{-2}	-2^0-2^{-6}	-2^{-2}	-2^0+2^{-5}	-2^0	-2^0-2^{-2}	
a_5	2^0	2^0-2^{-6}	2^0	2^1-2^{-2}	2^0	2^1+2^{-1}	2^0	2^1-2^{-2}	2^1	2^1+2^{-3}	
δ , dB	9.32	9.52	14.0	14.4	17.7	18.3	22.9	24.7	28.7	29.2	
δ_s , dB	139	150	122	132	109	123	93.6	111	91.7	102	

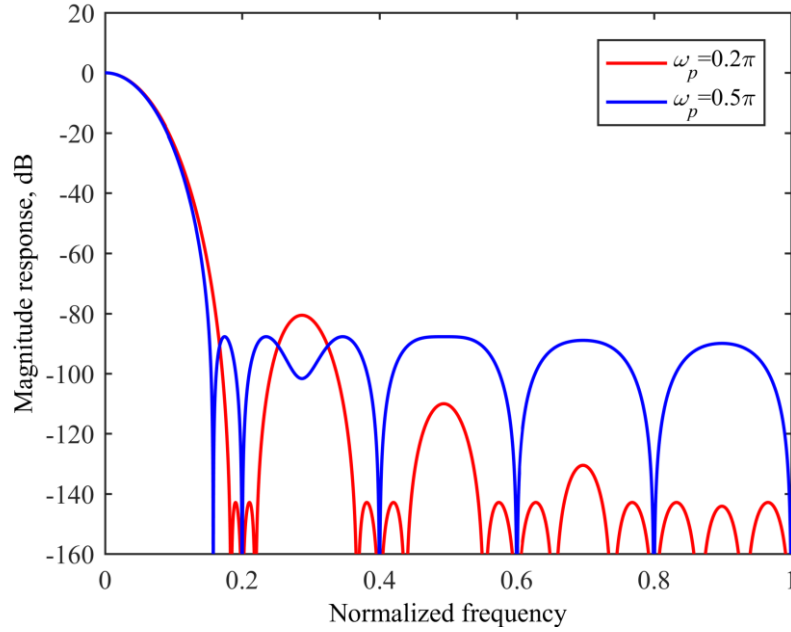

Figure 4.7 Magnitude responses of minimax SCIC filters with $N = 2$, $R = 10$, $M = 3$ and $P = 1$, assuming $\omega_p = 0.2\pi$ and $\omega_p = 0.5\pi$ [76].

Example 2. In this example, the design of multiplierless SCIC filters with high alias rejection is described. Such a filter can be obtained by the sharpening of the CIC response with $N = 2$ and $R = 10$, by using the polynomial with $M = 4$ and $P = 2$. The passband edge frequency $\omega_p = 0.4\pi$ is chosen. The optimum multiplierless filter is compared with the filter obtained by Chebyshev sharpening which utilizes real coefficients [61]. Figure 4.8 shows the magnitude responses of both filters. Generally, filters with SPT coefficients contain real gain constants, which is usually not implemented in practice. Therefore, only for comparison purposes, responses are normalized to 0 dB at $\omega = 0$. It is clear from the figure that the responses are very similar. The Chebyshev response ensures the minimum folding-band attenuation of 141 dB, whereas the multiplierless filter exhibits somewhat smaller attenuation of 139 dB. In the passband, both filters introduce nearly the same droop of 4.73 dB. From the complexity point of view, the Chebyshev SCIC filter [61] needs five general-purpose multipliers to incorporate sharpening polynomial. On the other hand, the proposed filter employs only six adders.

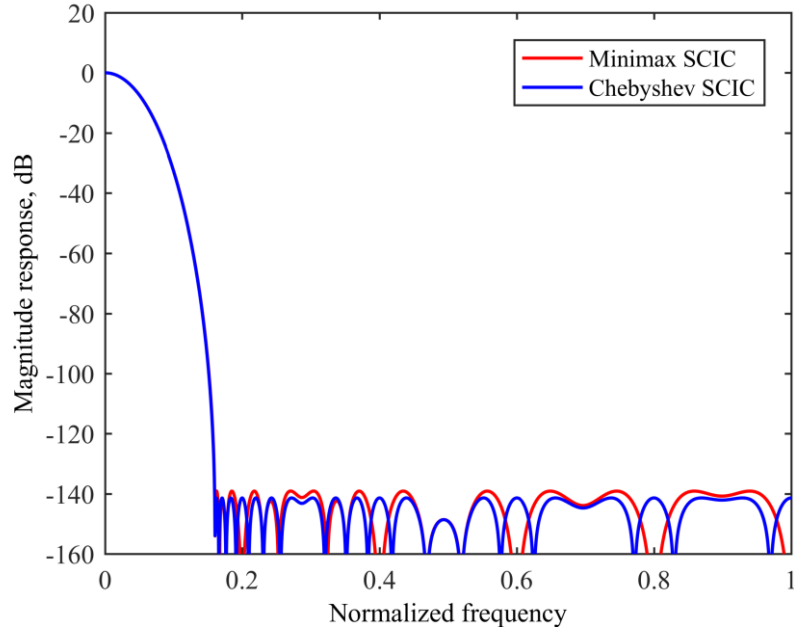

Figure 4.8 Magnitude responses of sharpened CIC filter with $N = 2$ and $R = 10$, obtained by minimax SPT sharpening with $M = 4$ and $P = 2$, and by Chebyshev sharpening of fourth-order [61], assuming $\omega_p = 0.4\pi$ [76].

4.5.4 Passband droop

The design of SCIC filters proposed in [61] and [76] results in filters with very high alias rejection. However, such a rejection is paid by monotonically decreasing passband response with rather high droop. To illustrate this behavior, minimax SCIC filters with $N = 2$, $R = 10$, $1 \leq M \leq 4$, and $P = 1$ are used. Figure 4.9 and Figure 4.10 show the obtained passband droops and the minimum folding-band attenuations, assuming $\omega_p = \pi/4$, $\omega_p = \pi/3$, and $\omega_p = \pi/2$. It is clear from Figure 4.10 that the folding-band attenuations increase with an increase in M . However, such behavior is paid by a high passband droop. This behavior is similar to the behavior of the CIC filters described in Section 2.3. Even though minimax SCIC filters have a better amplitude response than the CIC filters, their passband droop is still rather high. For example, for a given passband edge frequency $\omega_p = \pi/2$, the SCIC filter with $N = 2$, $M = 3$, and $P = 1$ has the minimum folding-band attenuation of 80 dB. However, it introduces the passband droop of 6 dB.

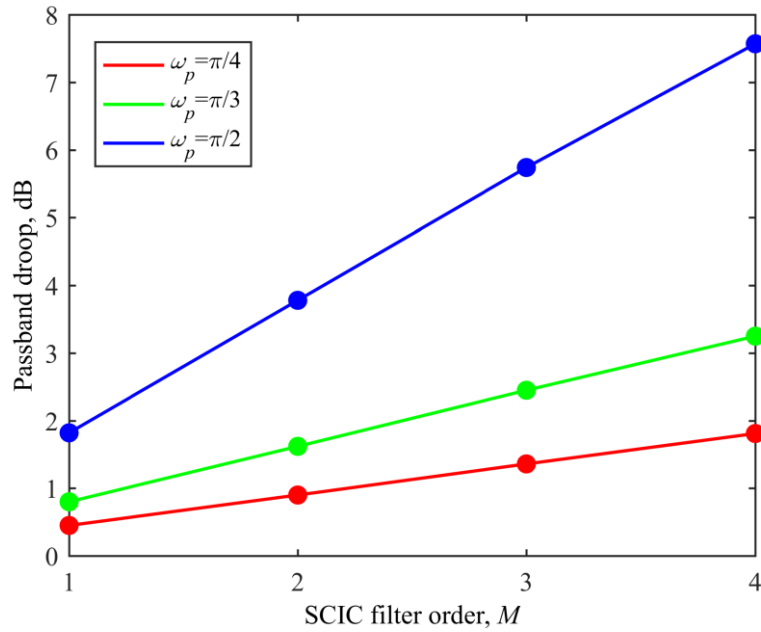

Figure 4.9 Passband droops of minimax SCIC filters with $N=2$, $R=10$, $1 \leq M \leq 4$ and $P=1$, assuming $\omega_p = \pi/4$, $\pi/3$ and $\pi/2$.

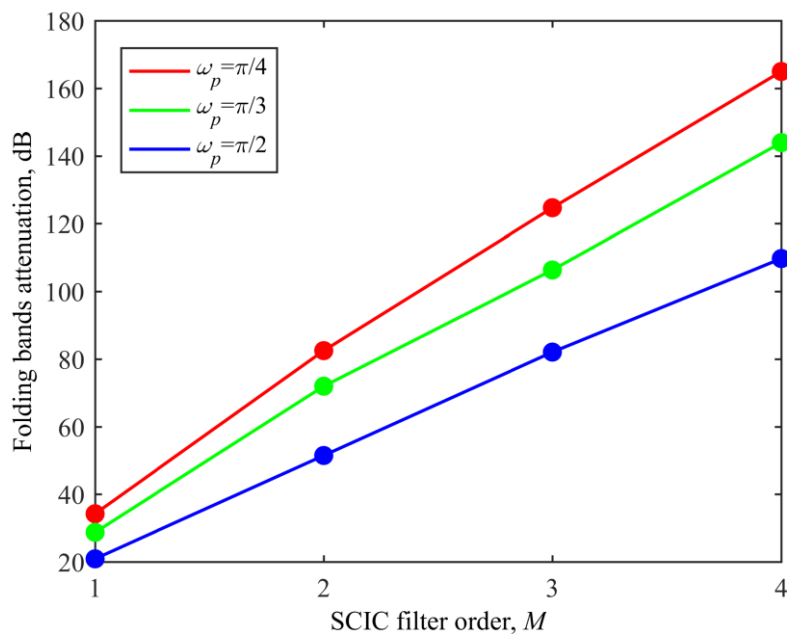

Figure 4.10 Minimum folding-band attenuations of minimax SCIC filters with $N=2$, $R=10$, $1 \leq M \leq 4$ and $P=1$, assuming $\omega_p = \pi/4$, $\pi/3$ and $\pi/2$.

5. COMPENSATORS FOR SHARPENED CIC FILTERS

Two approaches to the design of SCIC filters with incorporated passband compensation have been considered in the literature. In the first approach, the polynomial sharpening is used to *improve the compensated CIC response* [68], [69]. In comparison to the SCIC filters obtained by simultaneous sharpening the passband and folding-band response, these filters bring a similar response by employing sharpening polynomial of lower order. However, this approach results in the realization which incorporates multiple compensators having the same structure. The second approach is *compensation of the sharpened CIC response*. Here, the CIC response is improved by connecting a linear-phase FIR filter called SCIC compensator to the output of the SCIC decimator. Recently, single-stage SCIC compensators based on maximally flat [79] and minimax [80] approximations have been developed.

In the following sections, both approaches are described in detail.

5.1 Sharpening of compensated CIC filter

In [68], Romero *et al.* proposed sharpening of compensated CIC response. The compensated response has the form

$$F(\omega) = H_{CIC}(\omega)H(\omega R) \quad (5.1)$$

where $H(\omega R)$ is the amplitude response of the compensator relative to the high sampling rate. By substituting $x = F(\omega)$ into (4.1), the amplitude response of the sharpened compensated CIC filter is obtained. It is given by

$$H_{SF}(\omega) = \sum_{m=0}^M a_m F^m(\omega) \quad (5.2)$$

The filter in (5.2) can be realized by adding compensator $H(z)$ in cascade with each comb filter $C^N(z)$ in Figure 4.3. Multiplierless realization of such structure is ensured by representing the sharpening coefficients as SPT, assuming compensator is multiplierless. In [68], the sharpening coefficients are defined as

$$a_m = 2^{-B} p_m \quad ; \quad m = 0, 1, \dots, M \quad (5.3)$$

where B is wordlength of coefficient's fractional part and p_m is an integer value.

To obtain the coefficients, response in (5.2) is evaluated on uniformly spaced frequency grid $Q_p = \{\omega_{k,p}, k = 1, \dots, K\}$ defined within the passbands band $\Omega_p = [0, \omega_p]$, and on uniformly spaced frequency grid $Q_s = \{\omega_{k,s}, k = 1, \dots, K\}$ defined within the first folding-band $\Omega_s = [2\pi/R - \omega_p/R, 2\pi/R + \omega_p/R]$. Assuming the passband, δ_p , and stopband, δ_s , deviations are specified, the design is described by a *constrained mixed-integer programming (MILP)* problem, as in

$$\begin{aligned} \hat{\mathbf{s}} &= \arg \min_{\mathbf{s}} \mathbf{f}^T \mathbf{s} \\ &\text{subject to: } \mathbf{A} \mathbf{s} \leq \mathbf{b} \end{aligned} \quad (5.4)$$

where vectors \mathbf{s} , \mathbf{b} , \mathbf{f} , and matrix \mathbf{A} are given by

$$\mathbf{s} = [s_i], \quad \mathbf{f} = [f_i], \quad \mathbf{A} = [A_{i,j}], \quad \mathbf{b} = [b_i] \quad (5.5)$$

$$s_i = \begin{cases} \delta & ; \quad i = 1 \\ p_{i-2} & ; \quad i = 2, 3, \dots, M+2 \end{cases} \quad (5.6)$$

$$f_i = \begin{cases} 1 & ; \quad i = 1 \\ 0 & ; \quad i = 2, 3, \dots, M+2 \end{cases} \quad (5.7)$$

$$A_{i,j} = \begin{cases} -1 & ; \quad 1 \leq i \leq 2K, j = 1 \\ -\delta_s / \delta_p & ; \quad 2K \leq i \leq 4K, j = 1 \\ 2^{-B} [F(\omega_{i,p})]^{j-2} & ; \quad 1 \leq i \leq K, 2 \leq j \leq M+2 \\ -2^{-B} [F(\omega_{i-K,p})]^{j-2} & ; \quad K \leq i \leq 2K, 2 \leq j \leq M+2 \\ 2^{-B} [F(\omega_{i-2K,s})]^{j-2} & ; \quad 2K \leq i \leq 3K, 2 \leq j \leq M+2 \\ -2^{-B} [F(\omega_{i-3K,s})]^{j-2} & ; \quad 3K \leq i \leq 4K, 2 \leq j \leq M+2 \end{cases} \quad (5.8)$$

$$b_i = \begin{cases} 1 & ; \quad 1 \leq i \leq K \\ -1 & ; \quad K \leq i \leq 2K \\ 0 & ; \quad 2K \leq i \leq 3K \\ 0 & ; \quad 3K \leq i \leq 4K \end{cases} \quad (5.9)$$

and polynomial coefficients are determined by

$$a_m = 2^{-B} s_{i+2} \quad ; \quad m = 0, 1, \dots, M \quad (5.10)$$

The optimization problem in (5.4)–(5.10) is generally simple. Therefore, the solution can be obtained straightforward. An example of MATLAB code for solving this problem can be found in [78]. For illustration, the design is worked out for the CIC filter with $N = 2$ and $R = 10$, assuming the sine-based compensator described in Section 3.3.1.1, with $b = 1$ is incorporated in the structure. The sharpening polynomials are obtained assuming $M = 3$ and $\omega_p = \pi/4, \pi/3$, and $\pi/2$. Figure 5.1 shows the magnitude responses of the obtained filters. It is clear that the passband is efficiently improved. However, such sharpening does not provide high alias rejection, especially in the wideband case.

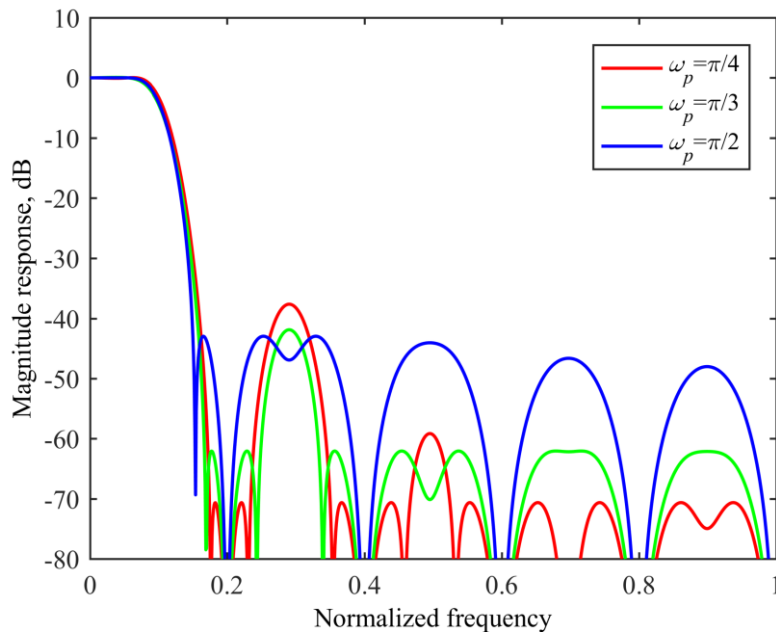

Figure 5.1 Magnitude responses of sharpened compensated CIC filter with $N = 2$ and $R = 10, M = 3$ [68].

5.2 Compensation of sharpened CIC filter

5.2.1 Narrowband compensators for sharpened CIC filters

The design of SCIC filters proposed in [61] and [76] results in filters with very high alias rejection. However, such a rejection is paid by monotonically decreasing passband response with rather high droop, leaving open the possibility of its improvement. In this section, the passband response is improved by connecting an FIR compensator in cascade with the SCIC filter [79].

5.2.1.1 Objective function

In [79], a closed-form method for the design of SCIC compensators which is based on the maximally flat error criterion has been developed. To obtain such compensator, the error function is defined as

$$E(\omega) = H(\omega)H_C(\omega) - H(0)H_C(0) \quad (5.11)$$

where $H_C(\omega)$ is the amplitude response of the sharpened CIC filter relative to the low sampling rate. The gain of the SCIC filter at $\omega = 0$ can be easily obtained as

$$K = H_C(0) = \sum_{m=0}^M a_m \quad (5.12)$$

To ensure that K is also the gain of the cascade, $H(0) = 1$ is assumed. Therefore, the error function is obtained as

$$E(\omega) = H(\omega)H_C(\omega) - K \quad (5.13)$$

To satisfy the maximally-flat error criterion at $\omega = 0$, the first n derivatives at $\omega = 0$ of the error function are set to 0, that is

$$E^{(n)}(\omega) \Big|_{\omega \rightarrow 0} = 0 \quad (5.14)$$

By substituting (5.13) into (5.14) and applying the Leibniz rule for the n -th derivative of a product, it follows

$$\sum_{k=0}^n \binom{n}{k} H^{(k)}(\omega) \Big|_{\omega=0} H_C^{(n-k)}(\omega) \Big|_{\omega \rightarrow 0} = 0 \quad (5.15)$$

The responses $H(\omega)$ and $H_C(\omega)$ are even functions of ω . Therefore, their odd-order derivatives evaluated at $\omega = 0$ are 0. The even-order derivatives at $\omega = 0$ of $H(\omega)$ are given by

$$H^{(n)}(\omega) \Big|_{\omega=0} = 2(-1)^{n/2} \sum_{k=1}^{(L-1)/2} k^n c_k \quad (5.16)$$

The even-order derivatives of $H_C(\omega)$ when $\omega \rightarrow 0$ can be expressed as

$$H_C^{(n)}(\omega) \Big|_{\omega \rightarrow 0} = \sum_{m=0}^M a_m \sum_{q=1}^{n/2} (2q-1) \left[-\frac{mN}{2} F^{(n-2q+1)}(\omega) \Big|_{\omega \rightarrow 0} \right]^q \quad (5.17)$$

where

$$F(\omega) = \frac{1}{R} \cot\left(\frac{\omega}{2R}\right) - \cot\left(\frac{\omega}{2}\right) \quad (5.18)$$

Since n is even, it is clear from (5.17) that only odd-order derivatives of $F(\omega)$ are required to find the derivatives of $H_C(\omega)$. The closed-form expression for odd-order derivatives of $F(\omega)$ when $\omega \rightarrow 0$ is given by [32]

$$F^{(n-2q+1)}(\omega) \Big|_{\omega \rightarrow 0} = 2 \frac{|B_{n-2q+2}|}{n-2q+2} \left(1 - \frac{1}{R^{n-2q+2}} \right) \quad (5.19)$$

where $B_n - 2q + 2$ are even-indexed Bernoulli numbers. They are given in an explicit form

$$B_{2r} = \frac{(-1)^{r-1} 2(2r)!}{(2\pi)^{2r}} \zeta(2r) \quad (5.20)$$

where $\zeta(s)$ is the Riemann zeta function [81]. By substituting (5.19) into (5.17), derivatives of $H_C(\omega)$ are obtained as

$$H_C^{(n)}(\omega) \Big|_{\omega \rightarrow 0} = \sum_{m=0}^M a_m \sum_{q=1}^{n/2} (2q-1) \left[\frac{mN |B_{n-2q+2}|}{n-2q+2} \left(\frac{1}{R^{n-2q+2}} - 1 \right) \right]^q \quad (5.21)$$

To design an SCIC compensator with an odd number of coefficients, the system of linear equations is formed by using (5.15), (5.16), and (5.21). For a given L , the even-order

derivatives of the orders from $n = 2$ to $n = L - 1$ are used in forming the system. Using (5.15), the system is obtained as

$$\mathbf{Q}\mathbf{c} = \mathbf{b} \quad (5.22)$$

where matrix \mathbf{Q} and column vectors \mathbf{c} and \mathbf{b} are given by

$$\begin{aligned} \mathbf{Q} &= [Q_{u,v}], \mathbf{c} = [c_u], \mathbf{b} = [b_u] \\ b_u &= \frac{1}{K} \sum_{r=0}^{u-1} \binom{2u}{2r} (-1)^{u+r-1} b_r H_C^{(2u-2r)}(\omega) \Big|_{\omega \rightarrow 0} ; \quad b_0 = \frac{1}{2} \\ u &= 1, 2, \dots, (L-1)/2 ; \quad v = 1, 2, \dots, (L-1)/2 \end{aligned} \quad (5.23)$$

The solution of the system in (5.22) is found as

$$\mathbf{c} = \mathbf{Q}^{-1}\mathbf{b} \quad (5.24)$$

Note that \mathbf{c} contains compensator's coefficients $c_1, c_2, \dots, c_{(L-1)/2}$, whereas the coefficient c_0 is still unknown. Its value is determined using the assumption $H(0) = 1$, it is given by

$$c_0 = 1 - 2 \sum_{k=1}^{(L-1)/2} c_k \quad (5.25)$$

Finally, the impulse response of the compensator is formed as

$$\mathbf{h} = [c_{(L-1)/2}, \dots, c_1, c_0, c_1, \dots, c_{(L-1)/2}] \quad (5.26)$$

Since the CIC filter is a special case of the SCIC filter, the proposed method can be considered as a generalization of the method in [32]

To illustrate the features of the proposed compensators, the compensation is performed using the Chebyshev SCIC filter [61] with $N = 2$, $R = 10$, and $M = 3$. Figure 5.2 shows the passband droop of the compensated Chebyshev SCIC filter obtained by different compensator's complexities. The curves are plotted for SCIC filters with passband edge frequencies $\omega_p = \pi/5$, $\omega_p = \pi/4$, and $\omega_p = \pi/3$, and for compensators with $L = 3, 5, 7, 9$, and 11 . The cases with $L = 1$ correspond to the droops of uncompensated filters. For the given band of interest, the Chebyshev SCIC filter introduces a rather high droop. The droop of the compensated filter generally decreases with an increase in the compensator's complexity. However, a significant decrease is accomplished for $L = 3$. The droop as low as 0.1 dB is achieved for $L = 5$, whereas a small improvement is encountered for $L = 7$.

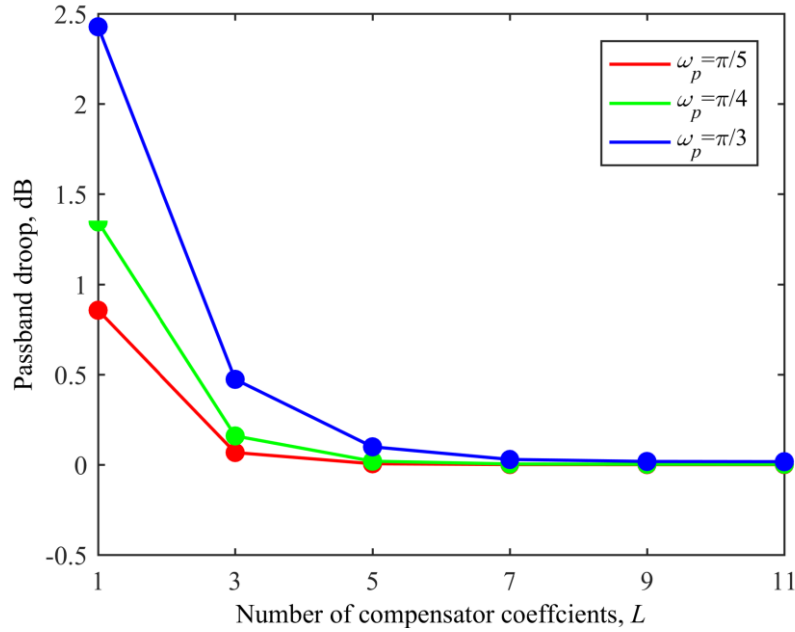

Figure 5.2 Passband droops of Chebyshev SCIC filters [61] with $N = 2$, $R = 10$, $M = 3$ compensated with maximally flat compensators [79].

It is known that the coefficients of maximally flat CIC compensators can be expressed in canonical-signed-digit (CSD) form if the decimation factors are powers of two. Consequently, the implementation of maximally flat CIC compensators is also multiplierless. This property also exists in described maximally flat SCIC compensators if the coefficients of the sharpening polynomials are from integer or SPT space. Following the previous discussion, only the compensators with three and five coefficients are considered. By using the framework in [42], for the compensator with three coefficients, compensator coefficients are defined as

$$c_0 = \frac{1}{K}d_0 \quad ; \quad c_1 = \frac{1}{K}d_1 \quad (5.27)$$

where

$$d_0 = K - 2d_1 \quad ; \quad d_1 = -2^{-5}NA\alpha \quad (5.28)$$

and

$$A = \frac{1 - R^{-2}}{1 - 2^{-2}} \quad (5.29)$$

$$\alpha = \sum_{m=0}^M ma_m \quad (5.30)$$

If $R = 2^I$, where I is a positive integer, A takes the SPT form [42]

$$A = \sum_{i=0}^{I-1} 2^{-2i} \quad (5.31)$$

It is clear that K in (5.12) and α in (5.30) can also be expressed using SPT representation if the sharpening polynomial coefficients are integers or sums of powers of two. Consequently, the coefficients d_0 and d_1 in (5.28) are CSD representable. Based on (5.27), it follows that d_0 and d_1 are the coefficients of the multiplierless compensator. By applying the same framework for the compensator with five coefficients, compensator coefficients are obtained as

$$c_0 = \frac{1}{K^2} s_0 \quad ; \quad c_1 = \frac{1}{K^2} s_1 \quad ; \quad c_2 = \frac{1}{K^2} s_2 \quad (5.32)$$

where

$$s_0 = K^2 - 2s_1 - 2s_2 \quad (5.33)$$

$$s_1 = -2^{-6} NB \left[2^{-2} NB\alpha^2 + 3K\alpha - 2^{-2} K(2^{-1} NB\beta + C\alpha) \right] \quad (5.34)$$

$$s_2 = 2^{-8} NB \left[2^{-2} NB\alpha^2 + K\alpha - 2^{-2} K(2^{-1} NB\beta + C\alpha) \right] \quad (5.35)$$

and

$$B = \frac{1 - R^{-2}}{1 - 2^{-2}} \quad (5.36)$$

$$C = \frac{1 - (2R)^{-2}}{1 - 2^{-4}} \quad (5.37)$$

$$\beta = \sum_{m=0}^M m^2 a_m \quad (5.38)$$

If $R = 2^{2J-1}$, assuming J is a positive integer, B and C take the SPT form [42], as in

$$B = \sum_{j=0}^{2J-2} 2^{-2j} \quad (5.39)$$

$$C = \sum_{j=0}^{J-1} 2^{-4j} \quad (5.40)$$

In addition, if sharpening polynomial coefficients are from integer or SPT space, β in (5.38) and, consequently, s_0 , s_1 , and s_2 in (5.33)–(5.35) can be expressed using CSD representation. From (5.32) it follows that s_0 , s_1 , and s_2 are the coefficients of the multiplierless compensator. The sharpening of the second-order CIC filter is common in literature. Such sharpening brings an additional reduction in the compensator complexity, what is illustrated with the compensator with five coefficients. By substituting $N = 2$ into (5.34) and (5.35); coefficients s_1 and s_2 take the reduced form

$$s_1 = -2^{-5} B \left[2^{-1} B \alpha^2 + 3K\alpha - 2^{-2} K(B\beta + C\alpha) \right] \quad (5.41)$$

$$s_2 = 2^{-7} B \left[2^{-1} B \alpha^2 + K\alpha - 2^{-2} K(B\beta + C\alpha) \right] \quad (5.42)$$

5.2.1.2 Compensator structure

Figure 5.3 and Figure 5.4 show the structures of the multiplierless compensators with three and five coefficients that improve the sharpened CIC filter of the second order. It is clear that the complexity of the compensator with three coefficients depends on realizations of constant multipliers $A\alpha$ and K , whereas the complexity of the compensator with five coefficients depends on realizations of B , α , $B\alpha$, $K(B\beta + C\alpha)$, K , and K^2 . The realization of B is given in [42]. However, the realizations of the remaining constant multipliers can be found representing them with a directed acyclic graphs described in Section 3.2.3.

$$\omega_p = \begin{cases} 0.164\pi & , \gamma^2 = 2^{-3} \\ 0.226\pi & , \gamma^2 = 2^{-4} \\ 0.187\pi & , \gamma^2 = 3 \cdot 2^{-5} \\ 0.354\pi & , \gamma^2 = 3 \cdot 2^{-7} \end{cases} \quad (5.43)$$

Searching for the optimum multiplierless realization of constant multipliers is a rather difficult task. To find the compensators for the given minimax and Chebyshev SCIC filters, we use the method based on graph representation described in Section 3.2.3. The corresponding constant multipliers are found by using the exhaustive search over the graphs shown in Figure 3.4. The constant multipliers and the total number of adders used in the compensators are given in Table 5.1 together with the passband droops and minimum folding-band attenuations of the compensated filters. It is clear that the compensators with three coefficients employ up to 10 adders and ensure the droop less than 0.1 dB. On the other hand, the compensators with five coefficients employ a high number of adders. However, they significantly improve the droop for passbands with $\omega_p > 0.3\pi$.

Example 2. In this example, two techniques for the improvement of the CIC filter amplitude response are compared. The first one simultaneously sharpens CIC amplitude response in the folding-bands and passband. The second sharpens CIC amplitude response in folding-bands and improves passband using proposed SCIC compensators. For comparison, the CIC filter with $N = 2$, $R = 32$, and $\omega_p = 0.226\pi$ is chosen. In both techniques, multiplierless realizations are considered. The first technique is represented with compensated CIC filter $y = [1 + 2^{-2} - 2^{-2}\cos(R\omega)]H_{CIC}(\omega)$ sharpened with the polynomial $f(y) = -3y + 195y^2 - 128y^3$ [68]. Second technique is illustrated with two examples: (i) Chebyshev SCIC filter obtained by the polynomial $f(x) = 1 - 2^9x + 2^{15}x^2$ [61] and then cascaded with the maximally flat compensator with $L = 3$, and (ii) minimax SCIC filter obtained by the polynomial $f(x) = -2^{-6}x + x^2$ [76] and then compensated with the maximally flat compensator with $L = 3$. Table 5.2 shows the obtained maximum passband deviations and minimum folding-band attenuations for all filters, whereas Figure 5.5 shows the corresponding magnitude responses relative to the high sampling rate. It is clear that the sharpened compensated-CIC filter ensures the lowest passband droop with the most complex structure. The compensated Chebyshev and minimax SCIC filter ensure the droop less than 0.1 dB. However, the compensated minimax SCIC filter is preferable with respect to the total number of adder.

Table 5.1 Constant multipliers and total Number of adders (N_A) used in multiplierless compensators together with passband droop (δ_P) and minimum folding-band attenuation (δ_S) of various compensated minimax and Chebyshev SCIC filters [79].

Compensated minimax SCIC filter with $N = 2$ and $R = 32$		
$M = 2$ and $\omega_p = \pi/5$, $p(x) = -2^{-7}x + x^2$ and $\delta_S = 86.0$ dB		
$L = 3$	$A\alpha = (2 + 2^{-1})(1 + 2^{-4})(1 - 2^{-10})$, $K = 1 - 2^{-7}$	$\delta_P = 0.04$ dB $N_A = 7$
$M = 2$ and $\omega_p = \pi/4$, $p(x) = -2^{-6}x + x^2$ and $\delta_S = 82.5$ dB		
$L = 3$	$A\alpha = (2 + 2^{-1})(1 + 2^{-4})(1 - 2^{-9}) - 2^{-7}$, $K = 1 - 2^{-6}$	$\delta_P = 0.09$ dB $N_A = 8$
$M = 3$ and $\omega_p = \pi/5$, $p(x) = 2^{-14}x - 2^{-6}x^2 + x^3$ and $\delta_S = 134$ dB		
$L = 3$	$A\alpha = [(2^2 + 2^{-4} + 2^{-6})(1 + 2^{-10}) + 2^{-17}](1 - 2^{-5})$, $K = 1 - 2^{-6} + 2^{-14}$	$\delta_P = 0.07$ dB $N_A = 10$
$M = 3$ and $\omega_p = \pi/3$, $p(x) = 2^{-10}x - 2^{-4}x^2 + x^3$ and $\delta_S = 106$ dB		
$L = 5$	$B = (1 + 2^{-2})(1 + 2^{-4}) + 2^{-8}$, $\alpha = 2 + 1 - 2^{-3} + 2^{-10}$, $B\alpha = 2^2 - (2 + 1)(1 - 2^{-3})(2^{-4} + 2^{-9} - 2^{-15})$, $K(B\beta + C\alpha) = [2^4 - (2 + 2^{-1})(1 - 2^{-8})](1 + 2^{-3})(1 - 2^{-5})^3$, $K = (1 - 2^{-5})^2$, $K^2 = (1 - 2^{-5})^4$	$\delta_P = 0.10$ dB $N_A = 33$
Compensated Chebyshev SCIC filter with $N = 2$ and $R = 32$		
$M = 2$ and $\omega_p = 0.164\pi$, $p(x) = 1 - 2^{10}x + 2^{17}x^2$ and $\delta_S = 102$ dB		
$L = 3$	$A\alpha = (2^{12} - 2^2)(2^4 + 1)(2^2 + 1)$, $K = 2^{17} - 2^{10} + 1$	$\delta_P = 0.02$ dB $N_A = 8$
$M = 2$ and $\omega_p = 0.226\pi$, $p(x) = 1 - 2^9x + 2^{15}x^2$ and $\delta_S = 90.2$ dB		
$L = 3$	$A\alpha = (2^9 - 1)(2^4 + 1)(2^3 + 2) - 2^8$, $K = 2^{15} - 2^9 + 1$	$\delta_P = 0.06$ dB $N_A = 9$
$M = 3$ and $\omega_p = 0.187\pi$, $p(x) = -1 + 27(2^6x - 2^{14}x^2 + 2^{20}x^3)$ and $\delta_S = 149$ dB		
$L = 3$	$A\alpha = (2^{16} - 2^{14} - 2^9 + 1)(2^{10} - 1)(2 + 2^{-2})$, $K = (2^{20} - 2^{14} + 2^6)(2^3 + 1)(2^2 - 1) - 1$	$\delta_P = 0.05$ dB $N_A = 13$
$M = 3$ and $\omega_p = 0.354\pi$, $p(x) = -1 + 27(2^4x - 2^{10}x^2 + 2^{14}x^3)$ and $\delta_S = 112$ dB		
$L = 5$	$B = (1 + 2^{-2})(1 + 2^{-4}) + 2^{-8}$, $\alpha = (2^{13} + 2^4)(2^5 - 1)(2^2 + 1)$, $B\alpha = (2^9 + 1)[(2^9 + 1)(2^3 - 2^{-1} - 2^{-4}) - 2^9]$, * $B\beta + C\alpha = [(2^{16} + 2^8)(2^2 - 1) + 2^{-3}](2^5 + 1) - 2^6(2^2 - 1)$, $K = (2^{10} - 2^6 + 1)(2^5 + 2^4)(2^3 + 1) - 1$, $K^2 = (2^{35} - 2^{12} - 2^7)(2^2 + 1) + (2^{24} + 1)(2^5 + 1) - 2^{21} + 2^{17}$ * leapfrog	$\delta_P = 0.14$ dB $N_A = 43$

Table 5.2 Maximum passband deviation (δ_p), minimum folding-band attenuation (δ_s), and the total number of adders (N_A) for various multiplierless CIC-based filters incorporating sharpening and compensation with $\omega_p = 0.226\pi$ [79].

CIC-based filter with $N=2$ and $R=32$	δ_p , dB	δ_s , dB	N_A
Sharpened compensated-CIC ($M=3$) [68]	$2e-3$	74.8	27
Compensated Chebyshev SCIC ($M=2, L=3$) [61]	0.06	90.2	19
Compensated minimax SCIC ($M=2, L=3$) [76]	0.06	84.2	17

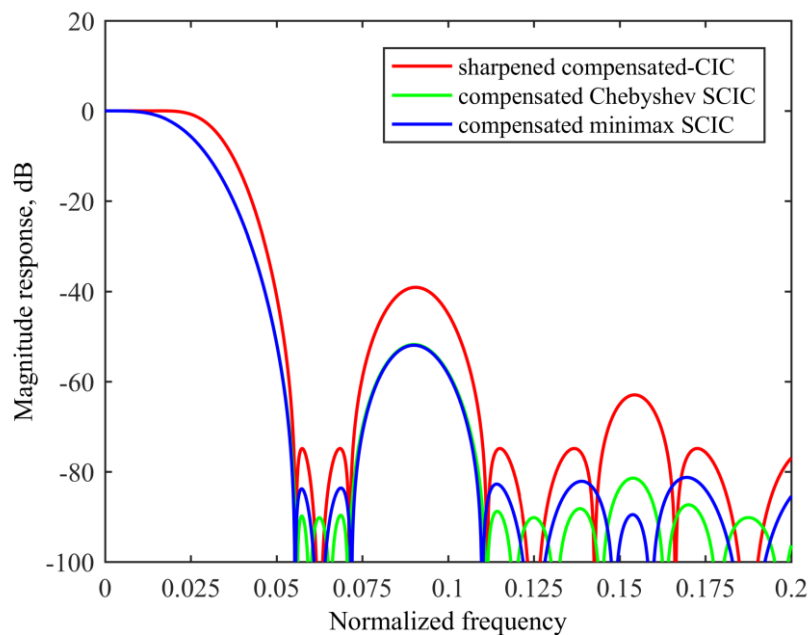

Figure 5.5 Magnitude responses at high rate of filters given in Table 5.2. Responses are shown up to third folding-band [79].

5.2.2 Wideband compensators for sharpened CIC filters

To obtain higher compensation capability in a wider passband than in the case of maximally flat compensation [79], the design of minimax SCIC compensators with minimum passband deviation over the SPT coefficient space has been developed [80]. In this design, all compensator coefficients are set as free variables. The complexity of the minimax compensators is controlled by specifying the total number of adders in the structure. In literature, such a design is known as the *total budget design*.

5.2.2.1 Objective function

To obtain wideband compensators, an objective function which measures maximum passband deviation normalized to the compensator's gain at $\omega = 0$ is used. The function is given by [49]

$$\varepsilon(\mathbf{c}) = \max_{\omega \in \Omega} \frac{H_C(\omega)H(\omega, \mathbf{c})}{H(0, \mathbf{c})} - \min_{\omega \in \Omega} \frac{H_C(\omega)H(\omega, \mathbf{c})}{H(0, \mathbf{c})} \quad (5.44)$$

where $\mathbf{c} = [c_0, c_1, \dots, c_{(L-1)/2}]^T$ is the vector of compensator's coefficients and $H_C(\omega)$ denotes the amplitude response of the first-order CIC filter. To obtain a minimum deviation, all coefficients are used as free variables. Furthermore, they are expressed as sums of SPT terms. Finally, the total number of SPT terms is restricted to a specified value, B . The optimum coefficients can be obtained by solving the problem

$$\begin{aligned} \hat{\mathbf{c}} &= \arg \min_{\mathbf{c}} [\varepsilon(\mathbf{c})] \\ \text{subject to: } c_k &= \sum_{r=0}^{W-1} b_{k,r} 2^r \quad ; \quad k = 0, 1, \dots, (L-1)/2 \\ &\sum_{k=0}^{(L-1)/2} \sum_{r=0}^{W-1} |b_{k,r}| = B \\ &H(0, \mathbf{c}) \neq 0 \end{aligned} \quad (5.45)$$

where $b_{k,r} \in \{-1, 0, 1\}$ and W is maximum coefficients' wordlength. To calculate $\varepsilon(\mathbf{c})$, the responses $H_C(\omega)$ and $H(\omega, \mathbf{c})$ are evaluated on uniformly spaced frequency grid within $0 \leq \omega \leq \omega_p$. The grid with 64 points is appropriate for the proposed compensator design. Note that the optimization in (5.45) does not force compensator's unity gain. Such an approach is common in the design of multiplierless filters. It is clear from (5.44) that $\varepsilon(\mathbf{c}) = \varepsilon(-\mathbf{c})$. Therefore, two global minimizers with opposite signs exist. However, we prefer the minimizer with $c_0 > 0$. This constraint is added to the constraints in (5.45). It simplifies the optimization because with this constraint only half of the coefficient space should be examined.

For small L , W , and B , the problem in (5.45) is simple and it can be solved by using the exhaustive search. The exhaustive search proves fast for compensators with $L \leq 7$, $W \leq 9$, and $B \leq 6$, which is sufficient for many applications. For convenience, we provide an example of MATLAB code implementing the entire design. The design function is called *scicomp* [80]. Its input parameters are vector w containing the frequency grid, response H_C evaluated on w , a

number of coefficients L , wordlength W , and the total number of terms, B . The function returns the coefficients expressed as integers, which can be easily converted into the sums of SPT terms.

```
function c=sciccomp(w,Hc,L,W,B)

% generation of coefficients
b=[-1,0,1]; [X{W:-1:1}]=ndgrid(1:3);
ck=b(reshape(cat(W+1,X{:}),[],W)); ck=ck(sum(abs(ck),2)<=B-1,:);
ck=sortrows([ck*2.^(W-1:-1:0)',sum(abs(ck),2)],[1,-2]);
u=[diff(ck(:,1))~=0; true]; bk=ck(u,2); ck=ck(u,1);
for Bk=0:B-1; Ck{Bk+1}=ck(bk==Bk); end;
K=(L+1)/2; N=0:B-1; [Y{K:-1:1}]=ndgrid(1:B);
P=N(reshape(cat(K+1,Y{:}),[],K));
Q=P(sum(abs(P),2)==B,:);

Hcos=ones(length(w),K); Hcos(:,2:K)=2*cos(w(:)*(1:K-1));

% optimization
epsi_min=realmax;
for q=1:size(Q,1)
    for k=1:K; S{k}=Ck{Q(q,k)+1}'; end;
    C=single(combvec(S{:}));
    H0=C(1,:)+2*sum(C(2:end,:),1); C=C(:,H0~=0 & C(1,:)>0);
    if ~isempty(C)
        H0= repmat(C(1,:)+2*sum(C(2:end,:),1),length(w),1);
        HC=repmat(Hc(:),1,size(C,2));
        [epsi,ind]=min(max(HC.*(Hcos*C)./H0)-min(HC.*(Hcos*C)./H0));
        if epsi<epsi_min; epsi_min=epsi; c=C(:,ind); end;
    end
end

% calculation of the gain closest the unity
while all(mod(c,2)==0); c=c/2; end;
```

5.2.2.2 Compensator structure and adder cost

The compensator is realized in a direct form, shown in Figure 3.3. It is well known that the computational complexity of the filter depends on the implementations of constant multipliers. The total number of adders required in the structure is

$$N_A = L - 1 + \sum_{k=0}^{(L-1)/2} N_A(c_k) \quad (5.46)$$

5.2.2.3 Design examples

Example 1. To illustrate features of the proposed design, sixth-order CIC filter [3] and the minimax SCIC filter with $f(x) = 2^{-8}x^2 - 2^{-3}x^4 + x^6$ [76] are compensated, assuming $R = 32$, $N = 1$ and $\omega_p = \pi/2$. These filters introduce the droops of 5.47 dB and 5.74 dB. Figure 5.6 shows the obtained passband deviations of the compensated filters for different compensators' complexities, assuming $W = 9$ and $2 \leq B \leq 6$. It is clear that the deviations decrease with an increase in B . However, for the compensators with $L = 3$, a significant improvement is encountered for $B \leq 3$, whereas for $L = 5$ the improvement is significant for $B \leq 5$. The compensators with $L = 3$ and $B = 2$ as well as with $L = 5$ and $B = 3$ correspond to the compensators described in [49].

Example 2. Figure 5.7 shows magnitude response of the CIC filter with $N = 6$ and $R = 32$, compensated with compensator given in [48] and proposed compensator. Passband edge frequency is $\omega_p = \pi/2$. The compensator with $L = 3$ in [48] provides the deviation of 0.76 dB by using four adders. However, the proposed compensator with $L = 3$ and $B = 3$ ensures a similar deviation by employing one adder less. It has the coefficients $\hat{\mathbf{c}} = [2^6, 1 - 2^4]$.

Example 3. In Figure 5.8, the proposed compensator is compared to recently proposed compensator with five coefficients [43]. For compensation, CIC filter from previous example is used. In [43], the CIC compensator with five coefficients exhibits the deviation of 0.11 dB by using 10 adders. Proposed compensator with $L = 5$ and $B = 6$ provides the same deviation, but it requires only seven adders. Its coefficients are $\hat{\mathbf{c}} = [-1 + 2^7, -2^3 - 2^5, -1 + 2^3]$.

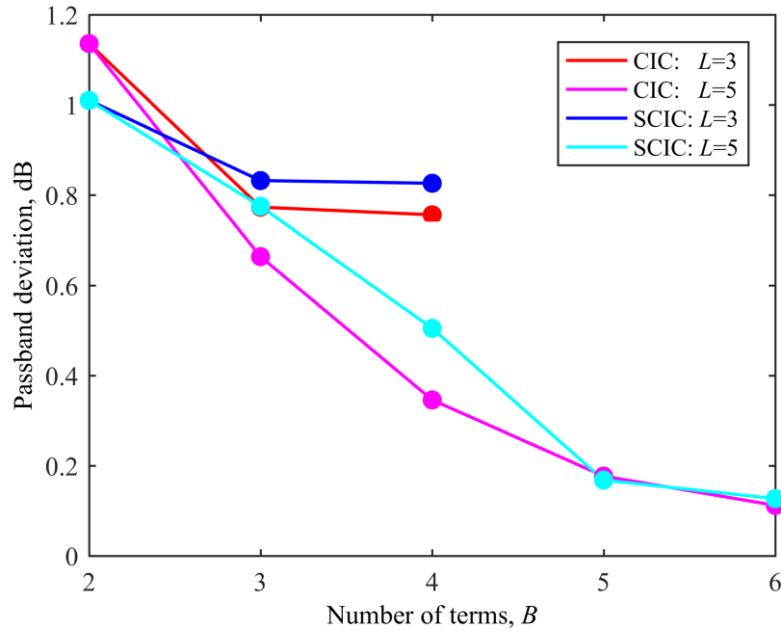

Figure 5.6 Passband deviations CIC and minimax SCIC filter with $R = 32$, assuming $|\omega| \leq \pi/2$ and $L = 3$ and 5 [80].

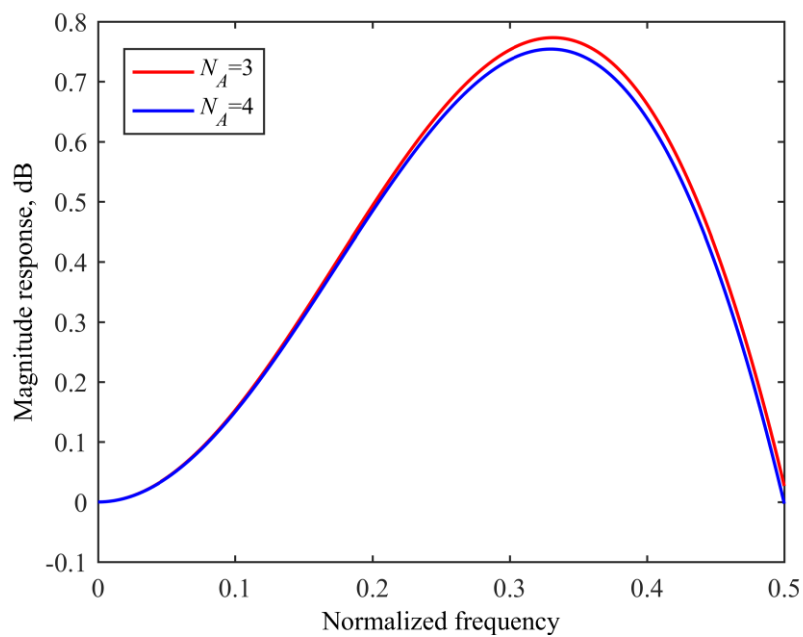

Figure 5.7 Magnitude responses of compensated CIC filter with $N = 6$ and $R = 32$, assuming $\omega_p = \pi/2$ and $L = 3$. For compensation, proposed compensator with $B = 3$ (red) and compensator in [48] (blue) are used. Compensators have N_A adders [80].

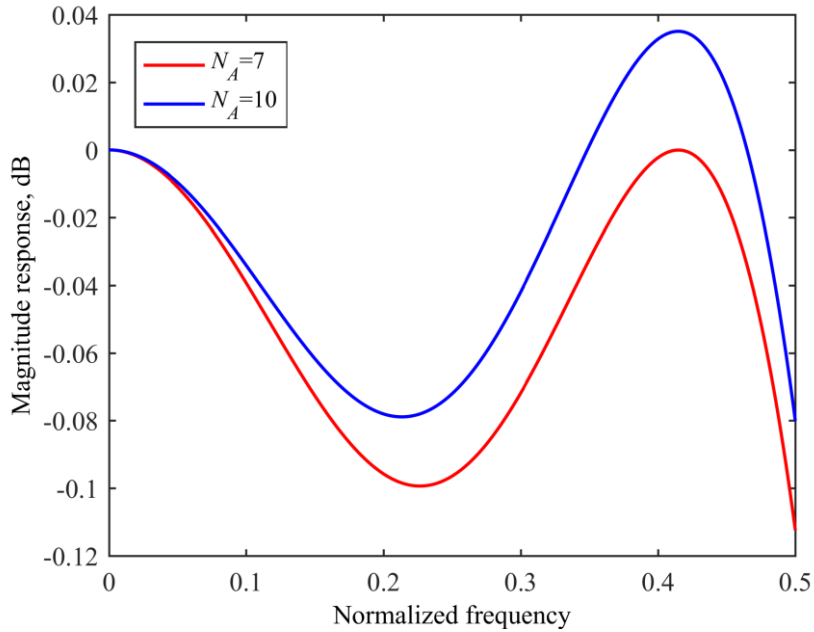
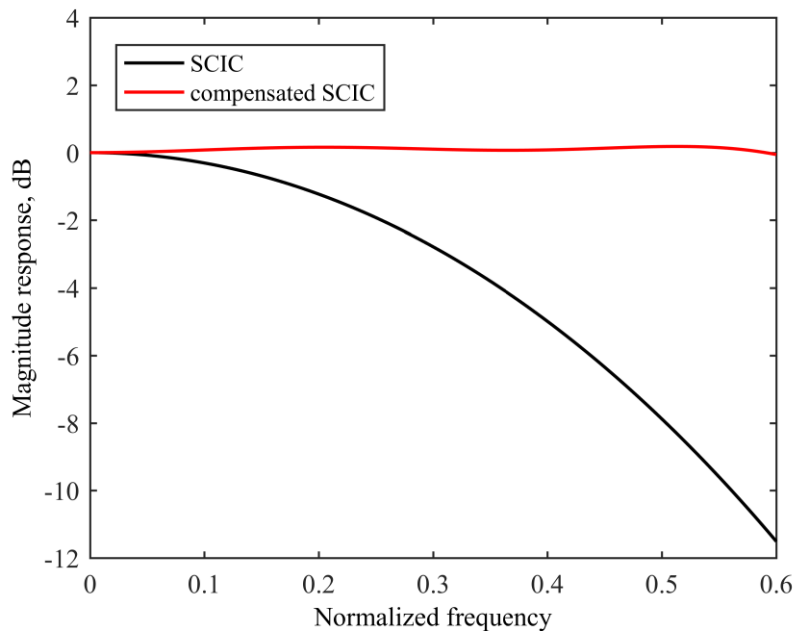

Figure 5.8 Magnitude responses of compensated CIC filter with $N = 6$ and $R = 32$, assuming $\omega_p = \pi/2$ and $L = 5$. For compensation, proposed compensator with $B = 3$ (red) and compensator in [43] (blue) are used. Compensators have N_A adders [80].

Example 4. This example illustrates the compensation of various minimax [76] and Chebyshev [61] SCIC filters with $\omega_p > \pi/5$, $R = 32$ and $N = 1$. The optimum coefficients and total number of adders used in the compensators are given in Table 5.3 together with passband droops of the original filters and the deviations of the compensated filters. In comparison with multiplierless SCIC compensators in [79], the proposed compensators generally bring lower deviations having a significantly lower number of adders at the same time. It is expected since the compensators in [79] were obtained by using the maximally-flat error criterion and without the control of complexity. To illustrate robustness of the design, CIC filter with $R = 32$ and $N = 1$ sharpened with polynomial $f(x) = -2^{-14}x^2 + 2^{-6}x^4 - 2^{-2}x^6 + x^8$ [76] is compensated using the compensator given in Table 5.3. Figure 5.9 shows original and compensated responses. Original response has rather high passband deviation of 11.5 dB. The proposed compensation results in the deviation of 0.24 dB, which is obtained by the compensator having only eight adders in structure.

Table 5.3 Optimum coefficients and total number of adders, N_A , used in compensators together with passband droop δ_P [80].

Compensated minimax SCIC filter with $R = 32$ and $N = 1$		
$f(x) = -2^{-6}x^2 + x^4, \omega_p = \pi/4, \delta = 0.90$ dB		
$L = 3, W = 7, B = 4$	$\hat{\mathbf{c}} = [2+2^6, -1-2^3]$	$\delta_p = 0.03$ dB, $N_A = 4$
$f(x) = 2^{-10}x^2 - 2^{-4}x^4 + x^6, \omega_p = \pi/3, \delta = 2.46$ dB		
$L = 5, W = 7, B = 4$	$\hat{\mathbf{c}} = [2^6, -1-2^4, 2]$	$\delta_p = 0.05$ dB, $N_A = 5$
$f(x) = 2^{-8}x^2 - 2^{-3}x^4 + x^6, \omega_p = \pi/2, \delta = 5.74$ dB		
$L = 5, W = 9, B = 6$	$\hat{\mathbf{c}} = [2^8, -2^2-2^4-2^6, -1+2^4]$	$\delta_p = 0.13$ dB, $N_A = 7$
$f(x) = -2^{-14}x^2 + 2^{-6}x^4 - 2^{-2}x^6 + x^8, \omega_p = 3\pi/5, \delta = 11.5$ dB		
$L = 7, W = 8, B = 6$	$\hat{\mathbf{c}} = [2^7, -2^6, 1+2^2+2^4, -2^2]$	$\delta_p = 0.24$ dB, $N_A = 8$
Compensated Chebyshev SCIC filter with $R = 32$ and $N = 1$		
$f(x) = 1 - 2^9x^2 + 2^{15}x^4, \omega_p = 0.226\pi, \delta = 0.74$ dB		
$L = 3, W = 5, B = 3$	$\hat{\mathbf{c}} = [-1+2^4, -2]$	$\delta_p = 0.02$ dB, $N_A = 3$
$f(x) = -1 + 27(2^4x^2 - 2^{10}x^4 + 2^{14}x^6), \omega_p = 0.354\pi, \delta = 2.77$ dB		
$L = 5, W = 9, B = 5$	$\hat{\mathbf{c}} = [-2^5+2^8, -2^6, 1+2^3]$	$\delta_p = 0.03$ dB, $N_A = 6$
$f(x) = -1 + 27(2^3x^2 - 2^8x^4 + 2^{11}x^6), \omega_p = 0.483\pi, \delta = 5.33$ dB		
$L = 5, W = 8, B = 6$	$\hat{\mathbf{c}} = [2^7, -1-2^3-2^5, -1+2^3]$	$\delta_p = 0.12$ dB, $N_A = 7$
$f(x) = 1 - 2^8x^2 + 5 \cdot 2^{11}x^4 - 2^{17}x^6 + 2^{19}x^8, \omega_p = 0.579\pi, \delta = 10.6$ dB		
$L = 7, W = 8, B = 6$	$\hat{\mathbf{c}} = [2^7, -2^6, 1+2^2+2^4, -2^2]$	$\delta_p = 0.21$ dB, $N_A = 8$

Figure 5.9 Magnitude responses of original and compensated SCIC filter [76] with $N = 1, M = 4$ and $R = 32$, assuming $L = 7$ and $B = 6$ [80].

Example 5. In this example, the CIC-based FIR decimation filter proposed in [23] is compensated with the described compensator. In this case, $H_C(\omega)$ in (5.44) denotes the passband response of the used CIC-based filter, rather than the response of an SCIC filter. As an example, the compensator with $L = 5$, $W = 8$, and $B = 5$ is designed for the filter with $N = 8$ and $R = 10$, assuming $\omega_p = 2\pi/5$. The optimum coefficients are obtained as $\hat{\mathbf{c}} = [2^7, 1 + 2^4 - 2^6, 2^3]$. Figure 5.10 and 5.11 show the magnitude response of the original and compensated CIC-based filter relative to the high and low sampling rate. The original filter introduces the droop of 4.76 dB. The proposed compensation results in the deviation of 0.05 dB, which is obtained by the compensator with only six adders.

All presented compensators have the coefficients with one, two, or three terms. However, if the design results in a coefficient with more than three terms, an additional decrease in number of adders is possible using the optimum realization of constant-coefficient multipliers, which is described in Section 3.2.3.

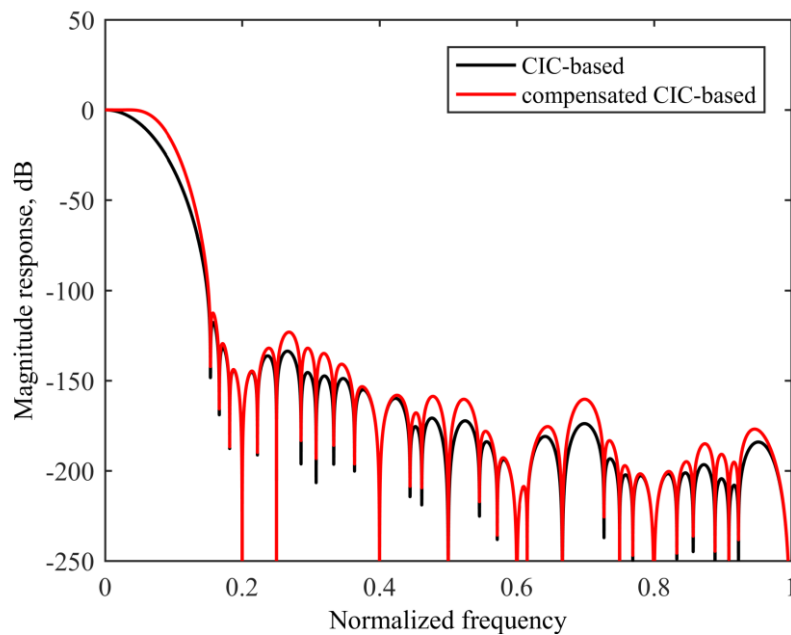

Figure 5.10 High-rate magnitude responses of original and compensated CIC-based FIR filter [23] with $R = 10$, assuming $\omega_p = 2\pi/5$ and $L = 5$ [80].

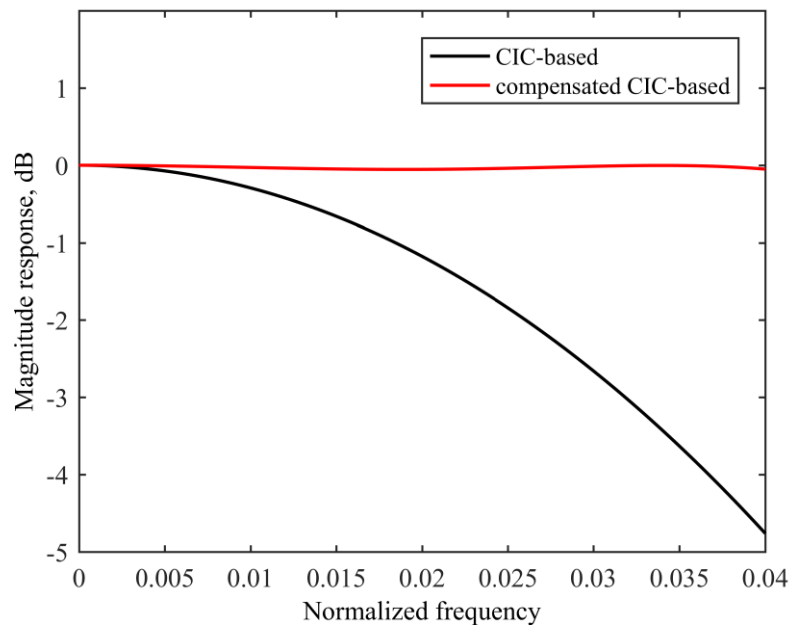

Figure 5.11 Low-rate magnitude responses of original and compensated CIC-based filter [23] with $R = 10$, assuming $\omega_p = 2\pi/5$ and $L = 5$ [80].

6. CONCLUSION

New methods for the design of multiplierless decimation filters with very high folding-band attenuations and low passband deviations have been developed. The methods consider the decimation filters incorporating folding-band sharpening and passband compensation into the CIC response. Three multiplierless filter structures have been considered, and include compensated CIC filters, sharpened CIC filters, and compensated sharpened-CIC filters.

To improve the passband droop of the CIC filter, two methods for the design of multiplierless CIC compensators have been developed. Both methods are based on minimization of the maximum passband deviation. However, the first method considers the design of unity gain compensator, whereas the second method considers the design of non-unity gain compensators. The obtained unity-gain compensators significantly improve narrow passbands by using the FIR transfer functions with three coefficients and by requiring the structures up to five adders. The proposed non-unity-gain compensators significantly improve wide passbands by using the transfer functions with five coefficients, which require structures with four adders only.

To increase the folding-band attenuation of CIC filters, the multiplierless sharpened CIC filters based on minimax sharpening have been proposed. The obtained filters exhibit similar amplitude response as the Chebyshev sharpened CIC filters. However, they provide multiplierless structures for arbitrary filter's specifications, which is not the case with the Chebyshev filters.

To improve the passband of the sharpened CIC filters, a straightforward method for the design of FIR compensators has been developed. The method is based on the maximally flat error criterion at the zero frequency. For the multiplierless sharpened-CIC filters with decimation factors expressed as a power of two, the maximally flat compensators can be realized as multiplierless. In addition, a narrow passband of the minimax and Chebyshev sharpened CIC filters can be efficiently improved by using the compensators with three coefficients, which require up to ten adders. On the other hand, for wideband sharpened-CIC compensation, a method for the design of multiplierless compensators providing the minimum passband deviation has been developed. The compensators obtained improve very high droops significantly, by employing the structures having up to eight adders.

7. REFERENCES

- [1] Mitola, J., "The software radio architecture", *IEEE Communication Magazine.*, Vol. 33, No. 5, May 1995., pp. 26–38.
- [2] Vučić, M., Molnar, G., Butorac, M., "FPGA Implementation of High-Frequency Software Radio Receiver", *Proceedings of 2009 IEEE International Symposium on Circuits and Systems*, Taipei, Taiwan, Republic of China, May 2009., pp. 1040–1043.
- [3] Hogenauer, E. B., "An economical class of digital filters for decimation and interpolation", *IEEE Transactions on Acoustics, Speech, and Signal Processing*, Vol. 29, No. 2, April 1981., pp. 155–162.
- [4] Dutta Roy, S. C., "Impulse response of sinc^N FIR filters", *IEEE Transactions on Circuits and Systems II: Express Briefs*, Vol. 53, No. 3, March 2006., pp. 217–219.
- [5] Zhang, C., Ofner, E., "Low Power Non-Recursive Decimation Filters", *Proceedings of 14th IEEE International Conference on Electronics, Circuits and Systems*, Marrakech, Morocco, December 2007., pp. 804–807.
- [6] Jang, Y., Yang, S., "Non-recursive cascaded integrator-comb decimation filters with integer multiple factors", *Proceedings of the 44th IEEE 2001 Midwest Symposium on Circuits and Systems*, Dayton, OH, USA, August 2001., pp. 130–133.
- [7] Losada, R. A., Lyons, R., "Reducing CIC filter complexity", *Streamlining Digital Signal Processing: A Tricks of the Trade Guidebook*, Wiley-IEEE Press, 2007.
- [8] Gao, Y., Jia, L., Isoaho, J., Tenhunen, H., "A Comparison Design of Comb Decimators for Sigma-Delta Analog-to-Digital Converters", *Analog Integrated Circuits and Signal Processing*, Vol. 22, No. 1, January 2000., pp. 51–60.
- [9] Romero, D. E. T., "Efficient CIC-based architecture with improved aliasing rejection and reduced computational complexity", *Electronics Letters*, Vol. 52, No. 15, July 2016., pp. 1294–1295.
- [10] Jovanović Doleček, G., Mitra, S. K., "Two-stage CIC-based decimator with improved characteristics", *IET Signal Processing*, Vol. 4, No. 1, January 2010, pp. 22–29.
- [11] Jovanović Doleček, G., Fernandez-Vazquez, A., "Multiplierless two-stage comb structure with an improved magnitude characteristic", *Proceedings of IEEE Asia Pacific Conference on Circuits and Systems (APCCAS)*, Jeju, Korea, October 2016., pp. 607–610.
- [12] Jovanović Doleček, G., Laddomada, M., "An improved class of multiplierless decimation filters: Analysis and design", *Digital Signal Processing*, Vol. 23, No. 5, September 2013., pp. 1773–1782.
- [13] Jovanović Doleček, G., Baez, J. R. G., Laddomada, M., "Design of efficient multiplierless modified cosine-based comb decimation filters: Analysis and implementation", *IEEE Transactions on Circuits and Systems I: Regular Papers*, Vol. 64, No. 5, May 2017., pp. 1051–1063.

- [14] Jovanović Doleček, G., "Improving comb alias rejection using modified cosine filters", *Proceedings of IEEE International Symposium on Circuits and Systems (ISCAS)*, Florence, Italy, May 2018., pp. 1–4.
- [15] Lo Presti, L., "Efficient modified-sinc filters for sigma-delta A/D converters", *IEEE Transactions on Circuits and Systems II: Analog and Digital Signal Processing*, Vol. 47, No. 11, November 2000., pp. 1204–1213.
- [16] Laddomada, M., "Generalized comb decimation filters for sigma-delta A/D converters: Analysis and design", *IEEE Transactions on Circuits and Systems I: Regular Papers*, Vol. 54, No. 5, May 2007., pp. 994–1005.
- [17] Laddomada, M., "On the polyphase decomposition for design of generalized comb decimation filters", *IEEE Transactions on Circuits and Systems I: Regular Papers*, Vol. 55, No. 8, September 2008., pp. 2287–2299.
- [18] Jovanović Doleček, G., Laddomada, M., "An economical class of droop-compensated generalized comb filters: Analysis and design", *IEEE Transactions on Circuits and Systems II: Express Briefs*, Vol. 57, No. 4, April 2010., pp. 257–279.
- [19] Mondal, K., Mitra, S., "Non-recursive decimation filters with arbitrary integer decimation factors", *IET Circuits, Devices & Systems*, Vol. 6, No. 3, May 2012., pp. 141–151.
- [20] Stošić, B. P., Pavlović, V. D., "On design of a novel class of selective CIC FIR filter functions with improved response", *AEU International Journal of Electronics and Communications*, Vol. 68, No. 8, August 2014., pp. 720–729.
- [21] Milić, D. N., Pavlović, V. D., "A new class of low complexity low-pass multiplierless linear-phase special CIC FIR filters", *IEEE Signal Processing Letters*, Vol. 21, No. 12, July 2014., pp. 1511–1515.
- [22] Stošić, B. P., Milić, D. N., Pavlović, V. D., "Innovative design of CIC FIR filter functions", *Proceedings of the 12th International Conference on Telecommunication in Modern Satellite, Cable and Broadcasting Services (TELSIKS)*, Niš, Serbia, October 2015., pp. 60–63.
- [23] Stošić, B. P., Pavlović, V. D., "Design of new selective CIC filter functions with passband-droop compensation", *Electronics Letters*, Vol. 52, No. 2, January 2016., pp. 115–117.
- [24] Laddomada, M., "Design of multistage decimation filters using cyclotomic polynomials: Optimization and design issues", *IEEE Transactions on Circuits and Systems I: Regular Papers*, Vol. 55, No. 7, August 2008., pp. 1977–1987.
- [25] Laddomada, M., Troncoso, D. E., Jovanović Doleček, G., "Design of multiplierless decimation filters using extended search of cyclotomic polynomials", *IEEE Transactions on Circuits and Systems II: Express Briefs*, Vol. 58, No. 2, February 2011., pp. 115–119.
- [26] Lim, Y. C., Yang, R., "On the synthesis of very sharp decimators and interpolators using the frequency-response masking technique", *IEEE Transactions on Signal Processing*, Vol. 53, No. 4, April 2005., pp. 1387–1397.
- [27] Kim, S., Lee, W. C., Ahn, S., Choi, S., "Design of CIC roll-off compensation filter in a W-CDMA digital IF receiver", *Digital Signal Processing*, Vol. 16, No. 6, November 2006., pp. 846–854.

- [28] Yeung, K. S., Chan, S. C., "The design and multiplier-less realization of software radio receivers with reduced system delay", *IEEE Transactions on Circuits and Systems I: Regular Papers*, Vol. 51, No. 12, December 2004., pp. 2444–2459.
- [29] Jovanović Doleček, G., Harris, F., "Design of wideband CIC compensator filter for digital IF receiver", *Digital Signal Processing*, Vol. 19, No. 5, September 2009., pp. 827–837.
- [30] Parks, T. W., McClellan, J. H., "Chebyshev approximation for nonrecursive digital filters with linear phase", *IEEE Transactions on Circuit Theory*, Vol. 19, No. 2, March 1972., pp. 189–194.
- [31] *MATLAB: Signal Processing Toolbox*, MathWorks, Inc., Natick, MA, USA, 2016.
- [32] Molnar, G., Vučić, M., "Closed-form design of CIC compensators based on maximally flat error criterion", *IEEE Transactions on Circuits and Systems II: Express Briefs*, Vol. 58, No. 12, December 2011., pp. 926–930.
- [33] *MATLAB: DSP System Toolbox*, MathWorks, Inc., Natick, MA, USA, 2016.
- [34] Avizienis, A., "Signed-digit number representations for fast parallel arithmetic", *IRE Transactions on Electronic Computers*, Vol. EC-10, No. 3, September 1961., pp. 389–400.
- [35] Dempster, A. G., Macleod, M. D., "Constant integer multiplication using minimum adders", *IEE Proceedings - Circuits, Devices and Systems*, Vol. 141, No. 5, October 1994., pp. 407–413.
- [36] Gustafsson, O., Dempster, A. G., Johansson, K., Macleod, M. D., Wanhammar, L., "Simplified design of constant coefficient multipliers", *Circuits, Systems and Signal Processing*, Vol. 25, No. 2, April 2006., pp. 225–251.
- [37] Fernandez Vazquez, A., Jovanović Doleček, G., "A general method to design GCF compensation filter", *IEEE Transactions on Circuits and Systems II: Express Briefs*, Vol. 56, No. 5, May 2009., pp. 409–413.
- [38] Romero, D. E. T., Salgado, G. M., Jovanović Doleček, G., "Simple two-adders CIC compensator", *Electronics Letters*, Vol. 51, No. 13, June 2015., pp. 993–994.
- [39] Jovanović Doleček, G., Mitra, S. K., "Simple method for compensation of CIC decimation filter", *Electronics Letters*, Vol. 44, No. 19, September 2008., pp. 1162–1163.
- [40] Romero, D. E. T., Jovanović Doleček, G., "Application of amplitude transformation for compensation of comb decimation filters", *Electronics Letters*, Vol. 49, No. 16, August 2013., pp. 985–987.
- [41] Jovanović Doleček, G., Fernandez Vazquez, A., "Trigonometrical approach to design a simple wideband comb compensator", *AEU-International Journal of Electronics and Communications*, Vol. 68, No. 5, May 2014., pp. 437–441.
- [42] Fernandez Vazquez, A., Jovanović Doleček, G., "Maximally flat CIC compensation filter: design and multiplierless implementation", *IEEE Transactions on Circuits and Systems II: Express Briefs*, Vol. 59, No. 2, February 2012., pp. 113–117.
- [43] Romero, D. E. T., Jimenez, M. G. C., "Efficient wide-band droop compensation for CIC filters: ad hoc and reconfigurable FIR architectures", *Electronics Letters*, Vol. 53, No. 4, February 2017., pp. 228–229.

- [44] Jovanović Doleček, G., Baez, R. G., Molina-Salgado, G., de la Rosa, J. M., "Novel multiplierless wideband comb compensator with high compensation capability", *Circuits, Systems, and Signal Processing*, Vol. 36, No. 5, May. 2017., pp. 2031–2049.
- [45] Romero, D. E. T., "On wideband minimum-phase CIC compensators", *Proceedings of 2016 IEEE International Conference on Electro Information Technology (EIT)*, Grand Foks, ND, USA, May 2016., pp. 0372–0375.
- [46] Jovanović Doleček, G., "Simple wideband CIC compensator", *Electronics Letters*, Vol. 45, No. 24, December 2009., pp. 1270–1272.
- [47] Hashemi, S. A., Nowrouzian, B., "Particle swarm optimization of FRM FIR digital filters over the CSD multiplier coefficient space", *Proceedings of 53rd IEEE International Midwest Symposium on Circuits and Systems*, Seattle, WA, USA, August 2010., pp. 1246–1249.
- [48] Molnar, G., Dudarin, A., Vučić, M., "Design of multiplierless CIC compensators based on maximum passband deviation", *Proceedings of 40th International Convention on Information and Communication Technology, Electronics and Microelectronics (MIPRO)*, Opatija, Croatia, May 2017., pp. 119–124.
- [49] Dudarin, A., Molnar, G., Vučić, M., "Simple multiplierless CIC compensators providing minimum passband deviation", *Proceedings of the 10th International Symposium on Image and Signal Processing and Analysis (ISPA)*, Ljubljana, Slovenia, September 2017., pp. 70–73.
- [50] Kearfott, R. B., *Rigorous Global Search: Continuous Problems*, Cluver Academic Publishers, 1996.
- [51] Hansen, E., Walster, G. W., *Global Optimization Using Interval Analysis*, Second Edition, Marcel Dekker, Inc., 2004.
- [52] Vučić, M., Molnar, G., Žgaljić, T., "Design of FIR filters based on interval analysis", *Proceedings of 33rd International Convention on Information and Communication Technology, Electronics and Microelectronics (MIPRO)*, Opatija, Croatia, May 2010., pp. 171–176.
- [53] Glavinić Pecotić, M., Molnar, G., Vučić, M., "Design of CIC compensators with SPT coefficients based on interval analysis", *Proceedings of 35th International Convention on Information and Communication Technology, Electronics and Microelectronics (MIPRO)*, Opatija, Croatia, May 2012., pp. 123–128.
- [54] Saramäki, T., Ritoniemi, T., "A modified comb filter structure for decimation," *Proceedings of IEEE International Symposium on Circuits and Systems. Circuits and Systems in the Information Age ISCAS '97*, Hong Kong, Hong Kong, June 1997., pp. 2353–2356.
- [55] Kaiser, J., Hamming, R., "Sharpening the response of a symmetric nonrecursive filter by multiple use of the same filter", *IEEE Transactions on Acoustics, Speech, and Signal Processing*, Vol. 25, No. 5, October 1977., pp. 415–422.
- [56] Kwentus, A. Y., Jiang, Z., Willson, A. N., "Application of filter sharpening to cascaded integrator-comb decimation filters", *IEEE Transactions on Signal Processing*, Vol. 45, No. 2, February 1997., pp. 457–467.
- [57] Stephen, G., Stewart, R. W., "High-speed sharpening of decimating CIC filter", *Electronics Letters*, Vol. 40, No. 21, October 2004., pp. 1383–1384.

- [58] Jovanović Doleček, G., Mitra, S. K., "A new two-stage sharpened comb decimator", *IEEE Transactions on Circuits and Systems I: Regular Papers*, Vol. 52, No. 7, July 2005., pp. 1414–1420.
- [59] Liu, Q., Gao, J., "Efficient comb decimation filter with sharpened magnitude response", *Proceedings of 5th International Conference on Wireless Communications, Networking and Mobile Computing*, Beijing, China, September 2009., pp. 1–4.
- [60] Zaimin, H., Yonghui, H., Wang, K., Wu, J., Hou, J., Ma, L., "A novel CIC decimation filter for GNSS receiver based on software defined radio", *Proceedings of 7th International Conference on Wireless Communications, Networking and Mobile Computing*, Wuhan, China, September 2011., pp. 1–4.
- [61] Coleman, J. O., "Chebyshev stopbands for CIC decimation filters and CIC-implemented array tapers in 1D and 2D", *IEEE Transactions on Circuits and Systems I: Regular Papers*, Vol. 59, No. 12, December 2012., pp. 2956–2968.
- [62] Molnar, G., Glavinić-Pecotić, M., Vučić, M., "Weighted least-squares design of sharpened CIC filters", *Proceedings of 36th International Convention on Information and Communication Technology, Electronics and Microelectronics (MIPRO)*, Opatija, Croatia, May 2013., pp. 91–95
- [63] Molnar, G., Vučić, M., "Weighted minimax design of sharpened CIC filters" *Proceedings of IEEE 20th International Conference on Electronics, Circuits, and Systems (ICECS)*, Abu Dhabi, United Arab Emirates, December 2013., pp. 869–872.
- [64] Laddomada, M., Troncoso, D. E., Jovanovic Doleček, G., "Improved sharpening of comb-based decimation filters: Analysis and design", *Proceedings of IEEE 11th Consumer Communications and Networking Conference (CCNC)*, Las Vegas, NV, USA, January 2014., pp. 11–16.
- [65] Jiménez, M. G. C., Reyes, V. C., Jovanovic Doleček, G., "Sharpening of non-recursive comb decimation structure", *Proceedings of 13th International Symposium on Communications and Information Technologies (ISCIT)*, Surat Thani, Thailand, September 2013., pp. 458–463.
- [66] Hartnett, R. J., Boudreaux-Bartels, G. F., "Improved filter sharpening", *IEEE Transactions on Signal Processing*, Vol. 43, No.12, December 1995., pp. 2805–2810.
- [67] Samadi, S., "Explicit formula for improved filter sharpening polynomial", *IEEE Transactions on Signal Processing*, Vol. 48, No. 10, October 2000., pp. 2957–2959.
- [68] Romero, D. E. T., Laddomada, M., Jovanovic Doleček, G., "Optimal sharpening of compensated comb decimation filters: analysis and design", *Scientific World Journal*, Vol. 2014, ID 950860, January 2014., pp. 1–9.
- [69] Jiménez, M. G. C., Troncoso Romero, D. E., Jovanovic Doleček, G., "On simple comb decimation structure based on Chebyshev sharpening", *Proceedings of IEEE 6th Latin American Symposium on Circuits & Systems (LASCAS)*, Montevideo, Uruguay, February 2015., pp. 1–4.
- [70] Jovanović Doleček, G., Mitra, S. K., "Efficient sharpening of CIC decimation filter", *Proceedings of IEEE International Conference on Acoustics, Speech, and Signal Processing (ICASSP)*, Hong Kong, China, April 2003., pp. VI–385.
- [71] Jiménez, M. G. C., Reyes, V. C., Jovanović Doleček, G., "Sharpening of non-recursive comb decimation structure", *Proceedings of 13th International Symposium on*

- Communications and Information Technologies (ISCIT)*, Surat Thani, Thailand, September 2013., pp. 458–463.
- [72] Jovanović Doleček, G., Mitra, S. K., "A new two-stage sharpened comb decimator", *IEEE Transactions on Circuits and Systems I: Regular Papers*, Vol. 52, No. 7, July 2005., pp. 1414–1420.
- [73] Romero, D. E. T., "Efficient CIC-based architecture with improved aliasing rejection and reduced computational complexity", *Electronics Letters*, Vol. 52, No. 15, July 2016., pp. 1294–1295.
- [74] Jimenez, M. G. C., Meyer-Baese, U., Jovanović Doleček, G., "Computationally efficient CIC-based filter with embedded Chebyshev sharpening for the improvement of aliasing rejection", *Electronics Letters*, Vol 53, No. 4, February 2017., pp. 281–283.
- [75] Laddomada, M., "Comb-based decimation filters for sigma-delta A/D converters: novel schemes and comparisons", *IEEE Transactions on Signal Processing*, Vol. 55, No. 5, April 2007., pp. 1769–1779.
- [76] Molnar, G., Dudarin, A., Vučić, M., "Minimax design of multiplierless sharpened CIC filters based on interval analysis", *Proceedings of 39th International Convention on Information and Communication Technology, Electronics and Microelectronics (MIPRO)*, Opatija, Croatia, May/June 2016., pp. 94–98.
- [77] Jovanović Doleček, G., "Compensated sharpened comb decimation filter", *Proceedings of 7th International Symposium on Image and Signal Processing and Analysis (ISPA)*, Dubrovnik, Croatia, September 2011., pp. 15–19.
- [78] Tawfik, S., "MATLAB function to solve MILP problems", accessible at: <http://www.mathworks.com/matlabcentral/fileexchange/6990-mixed-integer-lp/content/IP.m> (27. January 2013.).
- [79] Molnar, G., Dudarin, A., Vučić, M., "Design and multiplierless realization of maximally flat sharpened-CIC compensators", *IEEE Transactions on Circuits and Systems II: Express Briefs*, Vol. 65, No. 1, January 2018., pp. 51–55.
- [80] Dudarin, A., Molnar, G., Vučić, M., "Optimum multiplierless compensators for sharpened cascaded-integrator-comb decimation filters", *Electronics Letters*, Vol 54, No. 16, August 2018., pp. 971–972.
- [81] Gradshteyn, I. S., Ryzhik, I. M., "Table of Integrals, Series, and Products", Elsevier, 2007.

Curriculum Vitae

Aljoša Dudarin was born in 1987 in Osijek, Republic of Croatia. He received the master's degree in electrical engineering and information technology from the University of Zagreb Faculty of Electrical Engineering and Computing, Zagreb, Croatia, in 2011. After the Master study, he enrolled in the Doctoral study at the same faculty in the field of digital signal processing and filter design. In 2013, he was employed as a Software Engineer at Xylon - an electronics company focused on FPGA IP core designs. Since 2016 he works as a Software Developer in Ericsson Nikola Tesla d. d. Research and Development Centre, Radio Development Unit, in Zagreb. In the unit, he is a member of the Scientific Radio group, where he participates in the research activities of the project *Improvements for LTE Radio Access Equipment (ILTERA)* - an educational and research collaboration project between Ericsson Nikola Tesla d. d. and the Department of Electronic Systems and Information Processing of the Faculty of Electrical Engineering and Computing, University of Zagreb. He is a member of IEEE societies on Signal Processing and Circuits and Systems.

Publications:

- [1] **Dudarin, A.**, Molnar, G., Vučić, M., "Optimum multiplierless compensators for sharpened cascaded-integrator-comb decimation filters", *Electronics Letters*, Vol. 54, No. 16, 9th August 2018., pp. 971–972.
- [2] Molnar, G., **Dudarin, A.**, Vučić, M., "Design and multiplierless realization of maximally flat sharpened-CIC compensators", *IEEE Transactions on Circuits and Systems II: Express Briefs*, Vol. 65, No. 1, January 2018., pp. 51–55.
- [3] **Dudarin, A.**, Molnar, G., Vučić, M., "Simple multiplierless CIC compensators providing minimum passband deviation", *Proceedings of the 10th International Symposium on Image and Signal Processing and Analysis (ISPA)*, Ljubljana, Slovenia, September 2017., pp. 70–73.
- [4] Molnar, G., **Dudarin, A.**, Vučić, M., "Minimax design of multiplierless sharpened CIC filters based on interval analysis", *Proceedings of 39th International Convention on Information and Communication Technology, Electronics and Microelectronics (MIPRO)*, Opatija, Croatia, May/June 2016., pp. 94–98.
- [5] Molnar G., **Dudarin, A.**, Vučić, M., "Design of multiplierless CIC compensators based on maximum passband deviation", *Proceedings of 40th International Convention on Information and Communication Technology, Electronics and Microelectronics (MIPRO)* Opatija, Croatia, May 2017., pp. 119–124.

- [6] **Dudarin, A.**, Molnar, G., Vučić, M., " Design of multiplierless decimation filters based on amplitude sharpening and compensation", *Abstract Book of Third International Workshop on Data Science (IWDS)*, Zagreb, Croatia, October 2018., pp. 15–16.
- [7] Molnar G., **Dudarin, A.**, Vučić, M., "Design and multiplierless realization of multirate digital filters based on sharpening technique", *Abstract Book of First International Workshop on Data Science (IWDS)*, Zagreb, Croatia, November 2016., pp. 19–20.

Životopis

Aljoša Dudarin rođen je 1987. godine u Osijeku, Republika Hrvatska. Diplomirao je 2011. godine elektrotehniku i informacijsku tehnologiju na Sveučilištu u Zagrebu, Fakultet elektrotehnike i računarstva. Nakon diplomskog studija upisao je doktorski studij na istom fakultetu u području digitalne obrade signala i dizajna digitalnih filtara. Godine 2013., zaposlio se kao softverski inženjer u tvrtki Xylon - elektronička tvrtka usmjerena na FPGA dizajn. Od 2016. godine radi kao razvojni inženjer u kompaniji Ericsson Nikola Tesla d. d., Centar za istraživanje i razvoj, Jedinica za razvoj radija u Zagrebu. U jedinici je član znanstvene radio skupine, gdje sudjeluje u istraživačkim aktivnostima projekta *Poboljšanje karakteristika rada LTE radijskih pristupnih uređaja (ILTERA)* - obrazovano-istraživački kolaboracijski projekt između kompanije Ericsson Nikola Tesla d. d. i Zavoda za elektroničke sustave i obradbu informacija na Fakulteta elektrotehnike i računarstva, Sveučilište u Zagrebu. Član je IEEE društava za Obradu signala i Električne krugove i sustave.