

Modelling a decarbonized multi-energy industry facility as a flexibility service provider under price uncertainty

Kostelac, Matija

Doctoral thesis / Disertacija

2024

Degree Grantor / Ustanova koja je dodijelila akademski / stručni stupanj: **University of Zagreb, Faculty of Electrical Engineering and Computing / Sveučilište u Zagrebu, Fakultet elektrotehnike i računarstva**

Permanent link / Trajna poveznica: <https://urn.nsk.hr/urn:nbn:hr:168:735160>

Rights / Prava: [In copyright](#) / [Zaštićeno autorskim pravom.](#)

Download date / Datum preuzimanja: **2024-08-28**



Repository / Repozitorij:

[FER Repository - University of Zagreb Faculty of Electrical Engineering and Computing repository](#)





University of Zagreb

FACULTY OF ELECTRICAL ENGINEERING AND COMPUTING

Matija Kostelac

**MODELLING A DECARBONIZED MULTI-ENERGY
INDUSTRY FACILITY AS A FLEXIBILITY SERVICE
PROVIDER UNDER PRICE UNCERTAINTY**

DOCTORAL THESIS

Zagreb, 2024



University of Zagreb

FACULTY OF ELECTRICAL ENGINEERING AND COMPUTING

Matija Kostelac

**MODELLING A DECARBONIZED MULTI-ENERGY
INDUSTRY FACILITY AS A FLEXIBILITY SERVICE
PROVIDER UNDER PRICE UNCERTAINTY**

DOCTORAL THESIS

Supervisor: Associate Professor Tomislav Capuder, PhD

Zagreb, 2024



Sveučilište u Zagrebu
FAKULTET ELEKTROTEHNIKE I RAČUNARSTVA

Matija Kostelac

**MODELIRANJE DEKARBONIZIRANOGA
VIŠEENERGIJSKOGA INDUSTRIJSKOGA
POSTROJENJA KAO PRUŽATELJA USLUGA
FLEKSIBILNOSTI U UVJETIMA CJENOVNE
NESIGURNOSTI**

DOKTORSKI RAD

Mentor: izv. prof. dr. sc. Tomislav Capuder

Zagreb, 2024.

The doctoral thesis was completed at the University of Zagreb Faculty of Electrical Engineering and Computing, Department of Energy and Power Systems, Zagreb, Croatia.

Supervisor: Associate Professor Tomislav Capuder, PhD

Doctoral thesis has: 99 pages

Doctoral thesis number: _____

About the Supervisor

Tomislav Capuder was born in 1983 in Zagreb. He received his bachelor's and doctoral degrees from the Faculty of Electrical Engineering and Computing, University of Zagreb. At the same Faculty, he was elected as the assistant professor in 2016, and in 2020 as the associate professor. During his doctoral and postdoctoral studies, he spent several months in training at the University of Manchester in the UK. He won the Silver Josip Lončar Award for the best doctoral dissertation at Faculty of Electrical Engineering and Computing in 2013/2014, the Science Award of the Faculty of Electrical Engineering and Computing for 2015, Vera Johanides Award of the Croatian Academy of Engineering and many others.

His area of interest covers integrated energy infrastructure, multi-energy systems, electric power systems planning and operation, energy markets, modeling and optimization of electric power system, with emphasis on advanced distribution networks.

He is the author of a chapter in a book, 3 editorial books, more than 50 papers in category A journals and more than 80 papers in conference proceedings with international peer-review, and over 100 technical studies. He is the Editorial Board member in several international scientific and technical journals (International Transactions on Electrical Energy Systems is indexed in the Current Content database). In 2016, he received the award for the best reviewer of the IEEE Transactions on Smart Grid and the award for the best reviewer of the International Journal on Electrical Power and Energy Systems (both journals are indexed in the Current Content database), while in 2019 he received the award for the best reviewer of the IEEE Transactions on Smart Grid and IEEE Transactions on Power Systems.

He is the leader of several international and national research and development projects.

He was the secretary of international conferences Smart Grid World Forum 2010 and European Energy Market 2011, as well as the chairman of the board of international conference IEEE EUROCON 2013. He was also one of the presidents of the program committee of the international conference IEEE ENERGYCON 2014, and one of the members of the program committee of IEEE ENERGYCON 2016 and IEEE Energycon 2018. He was the president of international conference Medpower 2018.

He is a member of scientific and technical associations HRO CIGRE, SDEWES, IEEE, and he serves as a president of the Power & Energy Chapter in the Croatian IEEE section.

He speaks excellent English and speaks German at an intermediate level.

He is married and father of three children.

<https://orcid.org/0000-0002-7657-150X>

<https://scholar.google.hr/citations?hl=hr&user=I2dX-pkAAAAJ>

<https://www.scopus.com/authid/detail.uri?authorId=35222878400>

<https://www.webofscience.com/wos/author/record/1497711>

O mentoru

Tomislav Capuder rođen je 1983. godine u Zagrebu. Diplomirao je i doktorirao na Fakultetu elektrotehnike i računarstva Sveučilišta u Zagrebu. Na istom Fakultetu izabran je u znanstveno-nastavno zvanje docent 2016. godine, a 2020. Godine u znanstveno-nastavno zvanje izvanredni profesor. Tijekom doktorskog i poslijedoktorskog studija proveo je više mjeseci na usavršavanju na Sveučilištu u Manchesteru u Velikoj Britaniji. Dobitnik je nagrade Srebrni Josip Lončar za najbolju doktorsku disertaciju Fakulteta elektrotehnike i računarstva u 2013/2014 godini, Nagrade za znanost Fakulteta elektrotehnike i računarstva za 2015 godinu, Nagrade Vera Johanides Hrvatske akademije tehničkih znanosti te mnogih drugih.

Istraživački interesi obuhvaćaju integrirane energetske infrastrukture, višegeneracijske sustave, planiranje i vođenje elektroenergetskih sustava, tržišta energije, modeliranje i optimiranje elektroenergetskog sustava, s naglaskom na napredne distribucijske mreže.

Autor je poglavlja u knjizi, 3 uredničke knjige, više od 50 radova u časopisima kategorije A i više od 80 radova u zbornicima skupova s međunarodnom recenzijom, te preko 100 stručnih studija i elaborata. Član je uredničkih odbora nekoliko međunarodnih znanstveno stručnih časopisa (od čega je International Transactions on Electrical Energy Systems indeksira u Current Content bazi). U 2016. godini dobio je nagradu za najboljeg recenzenta časopisa IEEE Transactions on Smart Grid i nagradu za najboljeg recenzenta časopisa International Journal on Electrical Power and Energy Systems (oba časopisa indeksirana su u bazi Current Content), dok je u 2019. godini dobio je nagradu za najboljeg recenzenta časopisa IEEE Transactions on Smart Grid i IEEE Transactions on Power Systems.

Voditelj je više međunarodnih i nacionalni znanstveno-istraživačkih i razvojnih projekata.

Bio je tajnik međunarodnih konferencija Smart Grid World Forum 2010 i European Energy Market 2011 te predsjednik Organizacijskog odbora međunarodne konferencije IEEE EUROCON 2013. Također bio jedan od predsjednika programskog odbora međunarodne konferencije IEEE ENERGYCON 2014, te je jedan od članova programskog odbora IEEE ENERGYCON 2016 i IEEE Energycon 2018. Bio je predsjednik međunarodne konferencije Medpower 2018.

Član je znanstvenih i stručnih udruga HRO CIGRE, SDEWES, IEEE, a u Hrvatskoj sekciji IEEE trenutno obnaša dužnost Predsjednika Odjela za energetiku.

Izvršno se služi engleskim jezikom te na srednjoj razini koristi njemačkim jezikom.

Oženjen je i otac troje djece.

<https://orcid.org/0000-0002-7657-150X>

<https://scholar.google.hr/citations?hl=hr&user=I2dX-pkAAAAJ>

<https://www.scopus.com/authid/detail.uri?authorId=35222878400>

<https://www.webofscience.com/wos/author/record/1497711>

Abstract

With the current state of the power system where a lot of effort is being put into reducing greenhouse gas emissions at all levels, from production to consumption. This has resulted in strategies and plans for switching from classical electricity production methods, utilising fossil fuels, to environmentally cleaner renewable energy sources. It has also brought a change in the paradigm where before electricity production was handled by large centralised production units in favour of smaller distributed production. Distributed production is largely based on renewable energy sources that replace classic production based on fossil fuels. End-users started to become active participants in the power system with their local production and participate in different demand response programs. It is also important to emphasize the need for emission reduction at the consumer side. Most of the industrial facilities utilize fossil fuels, which produce large amounts of local emissions. Emission reduction can be implemented by replacing fossil fuels and incorporating renewable energy sources along with the facilities' internal flexibility to assist their operation.

Industrial facilities are a unique type of end-user. They are large centralised consumers whose production costs are largely dependent on energy procurement. Lowering their production costs can lead to a more competitive product. They have high flexibility potential since they are easier to control and automate than other end-users. They can also individually participate in the energy markets. The main concepts, where an industrial facility activates its flexibility potential, are demand response and integrating and shifting between multiple energy vectors. Demand response is a concept where end-users change their consumption pattern as a result of external signals. It is usually implemented through direct or indirect incentives. The models proposed in this thesis utilize indirect price-responsive demand response which schedules its production based on outside price signals, in this case the day-ahead market prices. Multi-energy systems concept entails that the system contains different energy vectors that can complement each other i.e. they can switch between each other when it is beneficial or it can be stored to use later. Prices in the electricity day-ahead market are not known beforehand so the model needs to take into account price uncertainty. Two different models are proposed and analysed through a two-stage stochastic optimisation model and a robust optimisation model, where the robust optimisation model outperforms the first one in terms of computational time. This model was then compared to a business-as-usual model without flexibility. Using its inherent flexibility, the proposed model outperforms the business-as-usual model and is able to mitigate market uncertainty.

Industrial facilities are responsible for local emissions, meaning that they have to purchase them in the emissions market, adding additional cost to their production process. To reduce their local emissions and carbon footprint as a whole, this thesis proposes switching from tra-

ditional fossil fuels to hydrogen technologies. They provide even more flexibility to the system since they can use excess electricity to produce hydrogen, or they can consume hydrogen to produce electricity and heat. Hydrogen can also be stored for future use. With a combination of hydrogen technologies and renewable energy sources, the industrial facility manages to almost entirely reduce its carbon footprint while completely avoiding local emissions. From the economical point of view, the current hydrogen technologies, on average, are still not up to par with the traditional ones . Future hydrogen technologies, reported in the literature, showcase better results depending on future price trends. The most promising benefit of the hydrogen-based system is that it is not very sensitive to market price changes since it can have high autonomy from the rest of the power system.

Keywords: industry facility; electricity market; demand-response; emission reduction; hydrogen technologies

MODELIRANJE DEKARBONIZIRANOGA VIŠEENERGIJSKOGA INDUSTRIJSKOGA POSTROJENJA KAO PRUŽATELJA USLUGA FLEKSIBILNOSTI U UVJETIMA CJENOVNE NESIGURNOSTI

Kako bi se smanjio negativan utjecaj klimatskih promjena puno truda se ulaže na smanjenje emisija stakleničkih plinova na svim razinama elektroenergetskog sustava. Veliki naglasak je na prelasku s klasičnih načina proizvodnje električne energije, korištenjem fosilnih goriva, na ekološki čistije obnovljive izvore energije. Također se događa promjena u paradigmi gdje se velika centralizirana proizvodnja električne energije zamjenjuje u korist manjih distribuiranih jedinica proizvodnje. Distribuirana proizvodnja se velikim dijelom temelji na obnovljivim izvorima energije kako bi zamijenila klasičnu proizvodnju baziranu na fosilnim gorivima. Krajnji korisnici postaju aktivni sudionici elektroenergetskog sustava jer mogu imati lokalnu proizvodnju i sudjelovati u različitim programima. Također je važno provesti smanjenje emisija na strani potrošača. Većina industrijskih postrojenja koristi fosilna goriva koja proizvode velike količine lokalnih emisija. Smanjenje emisija može se provesti zamjenom fosilnih goriva i uključivanjem obnovljivih izvora energije zajedno s unutarnjom fleksibilnošću postrojenja koja im pomaže u radu.

Industrijski potrošači su jako bitni sudionici elektroenergetskog sustava, čineći oko 25% ukupne potrošnje primarne energije u Europskoj uniji. Oni su centralizirani energetske intenzivni potrošači koji mogu djelovati samostalno bez potrebe za agregacijom s drugim potrošačima. Također, imaju visoku razinu kontrole i automatizacije svojih podsustava i pomoćnih uređaja. Zbog toga imaju puno veći potencijal fleksibilnosti. Troškovi njihove proizvodnje uvelike ovise o cijeni energenata, te se njihovim smanjenjem postiže veća konkurentnost proizvoda. Glavni koncepti koje će industrijsko postrojenje koristiti za postizanje svog potencijala fleksibilnosti su odziv potrošnje te kroz integriranje sustava više energetske vektora.

U radu će se prikazati mogućnosti industrijskih potrošača u tranziciji prema zelenoj energiji i njihova integracija na veleprodajna energetska tržišta. Industrijski potrošač modeliran je na temelju odziv potrošnje, gdje se raspored proizvodnog lanca optimizira s obzirom na vanjske utjecaje. Drugi dio modela je optimizacija pomoćnih uređaja koji se koriste za zadovoljavanje energetske potrebe proizvodnog lanca. Ova dva dijela modela međusobno se nadopunjuju, pružajući dodatnu fleksibilnost, budući da mogu pokrivati nedostatke jedni drugima. Energetske uređaje mogu koristiti različite izvore energije kako bi zadovoljili potrošnju postrojenja. Tradicionalno su izvori energije bili prirodni plin i/ili električna energija zbog njihove dostupnosti i cijene. Uzimajući u obzir naknade/dozvole za emisije za koje će industrija biti odgovorna, oni su potaknuti da ih smanje. Većina emisija proizvedena je izravno iz fosilnih goriva koja se ko-

riste lokalno ili neizravno iz električne energije kupljene na tržištu. U ovoj disertaciji predlaže se smanjenje emisija u dva koraka. Prvo je potrebno zamijeniti tradicionalno korištena fosilna goriva s vodikom, budući da su se njihove tehnologije pokazale primjerenima s operativnog stajališta. Mogu se koristiti za proizvodnju električne i toplinske energije te kao spremnik energije. Vodik se također može lokalno proizvesti korištenjem električne energije. Drugi korak je integracijom obnovljivih izvora energije, kao što je fotonaponska elektrana, kako bi se smanjila potreba za uvozom električne energije i pružila pomoć vodikovim tehnologijama u radu. Proizvodnja električne energije iz fotonapona ne proizvodi emisije, čime se smanjuje ukupni ugljični otisak postrojenja.

Ukratko, disertacija će prikazati mogućnosti industrijskog potrošača koji koristi fleksibilnost odziva potrošnje i energetske uređaja. Također, će integrirati rad industrijsko postrojenje na neizvjesnom tržištu električne energije. Veliki naglasak bit će stavljen na smanjenje emisije stakleničkih plinova korištenjem vodikovih tehnologija i obnovljivih izvora energije kako bi se zamijenile tehnologije temeljene na fosilnim gorivima. Prema tome izvorni znanstveni doprinosi ovog rada su sljedeći:

- Matematički model višeenergijskog industrijskog potrošača s odzivom potrošnje sa planiranjem procesa, integriran u neizvjesnom okruženju različitih energetske tržišta.
- Matematički model višerazinskog višeenergijskog industrijskog potrošača koji iskorištava interakciju vodika i obnovljivih izvora energije.

Koncept odziv potrošnje nije nov, ali je dobio na popularnosti zahvaljujući promjenama koje su se dogodile u elektroenergetskom sustavu. U osnovi, ovim programom krajnji korisnici mogu promijeniti svoj obrazac potrošnje od planiranog kako bi ostvarili određenu dobit. Dobit od sudjelovanja u ovom programu je obično financijske prirode, bilo kroz izravna plaćanja ili kroz smanjenje troškova električne energije. Iz perspektive operatora sustava, odziv potrošnje pruža dodatnu fleksibilnost koju može koristiti umjesto klasičnih pružatelja pomoćnih usluga. To je dodatno naglašeno povećanjem obnovljivih izvora energije koji zahtijevaju veću fleksibilnost i smanjenjem tradicionalnih izvora električne energije koji su povijesno pružali usluge fleksibilnosti. Također se može koristiti za lokalne svrhe kao što je upravljanje zagušenjem u mreži ili regulacija napona u distribucijskoj mreži. Odziv potrošnje može se koristiti za uravnoteženje proizvodnje i potrošnje bilančnih grupa. Odziv potrošnje obično ne zahtijeva velika ulaganja, barem u usporedbi s klasičnim pružateljima fleksibilnosti kao što su plinske turbine. Obično se u literaturi odziv potrošnje dijeli na cjenovni i poticajni. S programom odziv potrošnje koji se temelji na poticajima, pružatelja usluge fleksibilnosti je pozvan od treće strane da izvrši uslugu, bilo da je to operater sustava ili neka druga bilančna grupa, i za to dobiva dogovorenu naknadu. Provođenje ovakvog načina odziv potrošnje se može automatizirati tako

da se aktivira kada dobije vanjski signal i kada se ispune određeni uvjeti (obično ih postavlja pružatelj usluge). Najbolji primjer bi bili termostatski kontrolirani tipovi jedinica (hladnjaci, klima-uređaji, grijači prostora, itd.) koji mogu automatski smanjiti ili povećati svoju snagu na zahtjev dok god ostaju između unaprijed definiranih temperaturnih ograničenja koje je postavio pružatelj usluga odziva potrošnje. U odzivu potrošnje koji se temelji na cjenovnim poticajima, raspored potrošnje krajnjeg korisnika ili promijene njihove proizvodnje se temelji na vanjskim cijene. Te cijene koje krajnji korisnik uzima u obzir mogu doći iz različitih izvora kao što je tržište dan unaprijed, od agregatora ili opskrbljivača u vidu vremenski promjenjivih tarifa.

Literatura obično postavlja industrijska postrojenja kao ključna u integraciji odziva potrošnje u elektroenergetskom sustavu. Iako su važni, dosta ih zanemaruje u korist manjih potrošača iz drugih sektora. Iz tržišne perspektive glavne prepreke odziva potrošnje industrijskih postrojenja uključuju nepotpuna i nekonkurentna tržišta, nedostatak podataka čije prikupljanje možda nije isplativo i nesigurnosti na tržištu koje mogu spriječiti sudjelovanje. Iz društvene perspektive sudionici možda neće htjeti izvršiti potrebna ulaganja ili slijepo prihvatiti opremu koja im se daje kao sredstvo poticaja bila ona dobra za njih ili ne. Osim toga, gubitak udobnosti/proizvodnje glavna je briga za industrijske potrošače jer može izazvati veće gubitke nego što je dobit od sudjelovanja u programu odziva potrošnje. Tehnološke prepreke mogu uključivati bilo koju tehnologiju, vještinu ili znanje potrebnu za pravilno sudjelovanje u programu odziv potrošnje. Iz regulatorne perspektive, većina politika u postojećim elektroenergetskim sustavima se još uvijek temelji na velikim generatorima ostavljajući manje prostora za sudjelovanje u programu odziva potrošnje.

Višenergijski sustav je vrsta sustava koji sadrži različite energetske vektore koji mogu surađivati i nadopunjavati se, te pohranjujući energiju u različitim oblicima za kasniju upotrebu. Prebacivanje između energetske vektora obično se vrši kao odgovor na vanjske signale, npr. sustav prelazi na lokalnu proizvodnju električne energije u vrijeme visokih cijena električne energije. Dodatno, ova vrsta sustava može pružiti usluge fleksibilnosti operateru sustava. Konceptualno višeenergijski sustavi vrlo su slični konceptu odziva potrošnje budući da oba pružaju unutarnju fleksibilnost sustava. Za razliku od odziva potrošnje, višeenergijski sustav neće imati gubitke u proizvodnji jer će se njegova potrošnja zadovoljiti drugim energetske vektorom. Na njega utječu samo različite učinkovitosti energetske vektora. Fleksibilnost odziva potrošnje i fleksibilnost iz više energetske vektora se mogu koristiti zajedno kako bi se nadopunjavale i pomogle industrijskom postrojenju da postigne veće uštede.

U radovima koji su dio ovog istraživanja napravljeno je više model kako bi se prikazao rad industrijskog postrojenja. Prvi model industrijskog potrošača se natječe pod neizvjesnim cjenovnim uvjetima na tržištu dan unaprijed. Postrojenje također mora podmiriti troškove odstupanje od planirane potrošnje/proizvodnje prema cijeni temeljenoj na cijenama sekundarne regulacije. Tržišni model postavljen je kao dvostupanjski stohastički model s neizvjesnom ci-

jenom električne energije na dan unaprijed tržištu. Glavna fleksibilnost koja se koristi u ovom modelu dolazi s promjenom između dva energetska vektora, električne energije i plina. Ovaj model predstavlja poboljšanje tradicionalnog industrijskog postrojenja bez potrebe za značajnim promjenama. U idućoj iteraciji, model je poboljšán u uvođenjem odziva potrošnje. Odziv potrošnje je program u kojem korisnik može promijeniti svoj obrazac potrošnje na temelju izravnog poticaja ili vanjskog signala. Proizvodni procesni lanac industrijskog potrošača modeliran je kao odziv potrošnje koji reagira na vanjske cijene. Industrijski potrošač mora proizvesti željenu količinu krajnjeg proizvoda, ali može pomicati svoju proizvodnju kroz cijeli horizont optimizacije. Model je izrađen kao dvostupanjski stohastički i kao robusni model. Robusni model se pokazao superiornijim i prema rezultatima i iz perspektive računarske složenosti. Analiza je pokazala da je odziv potražnje imao veći utjecaj od višeenergijskog, iako se njegov utjecaj nije zanemariv s obzirom na to da doprinosi smanjenju troškova. Aktivno sudjelovanje na tržištu i korištenje različitih opcija fleksibilnosti dalo je bolje rezultate od pasivnog koje predstavlja tradicionalni pristup vođenja industrijskog postrojenja. Zbog svoje velike fleksibilnosti, predloženo industrijsko postrojenje se može prilagoditi neizvjesnim prilikama na tržištu, te nije jako osjetljivo na nagle promjene cijena.

U nastojanju da se umanjili negativni učinci klimatskih promjena mnoge su se zemlje krenule provoditi politike za njihovo smanjenje kroz različite međunarodne, nacionalne ili lokalne sporazume. Počevši od Kyoto protokola iz 1997. godine te nastavljajući s Pariškim sporazumom iz 2016. godine. Predvodnik u svemu ovom je Europska unija s vlastitim skupom politika kojima je cilj postići klimatsku neutralnost do 2050. godine kroz Europski zeleni plan s ranijim ciljem postizanja 55% manjih neto emisija stakleničkih plinova do 2030. godine u usporedbi s razinama iz 1990. godine kroz Spremnost za 55 paket. Paket Čista energija za sve Europljane usmjeren je na dekarbonizaciju energetskog sustava kroz energetsku učinkovitost, obnovljive izvore energije, regulaciju upravljanja i druge nezakonodavne inicijative. Iz perspektive industrijskih postrojenja, ona će dobiti besplatne dozvole za količinu emisiju stakleničkih plinova na temelju 10% instalacija s najboljim rezultatima prema određenom proizvodu. Metodologija ne uzima u obzir tehnologiju ili korištene energente, što znači da će industrijska postrojenja koja ne dostignu referentnu vrijednost od 10% dobiti manje emisijskih jedinica nego što im je potrebno te će morati smanjiti svoje emisije ili kupiti dodatne emisije. Za manje izložene sektore besplatne kvote se više neće dodjeljivati od 2023. godine, što znači da će industrijska postrojenja morati plaćati sve emisije koje proizvedu. Dekarbonizaciji industrijskih postrojenja može se pristupiti s različitih točaka gledišta. Neki tome pristupaju iz perspektive energetske učinkovitosti, bolje učinkovitosti resursa, boljeg iskorištavanja nusproizvoda, optimizacije proizvodnog procesa, supstitucije fosilnih goriva, integracije obnovljivih izvora energije i elektrifikacije

postrojenja. Ova doktorska disertacija će se fokusirati na neke od ovih koncepata, uglavnom na optimizaciju proizvodnog procesa, zamjenu fosilnih goriva i integraciju obnovljivih izvora energije. Ostali koncepti su zanemareni uglavnom zato što su specifični s obzirom na vrstu industrijskog procesa i finalnog proizvoda. Glavne prepreke za brže i efikasnije smanje emisija koje su prepoznate u literaturu su ekonomske naravi, manjak informacija i razmjena znanja, nedostatak obuke osoblja, nesklonost usvajanju novih tehnologija i manjak poticaja i regulacija

Nastojanjem da se smanje emisije stakleničkih plinova, vodik se pokazao kao energetski vektor koji može zamijeniti fosilna goriva. Tehnologije vodika nisu novi koncept, ali su njihova istraživanja su dobila na snazi s novim poticajima na globalnoj razini. Prema njihovom predviđanju, oko 60% svih smanjenja emisija stakleničkih plinova doći će iz obnovljivih izvora energije, zelenog vodika i elektrifikacije korištenjem tehnologija s niskim udjelom ugljika. Glavna prednost vodika je što se može koristiti za različite primjene u elektroenergetskom sustavu. Također, ne proizvodi nikakve lokalne emisije, ako se proizvodi iz čiste električne energije (npr. obnovljivi izvori energije) može se smatrati da ne proizvodi nikakve emisije. Iako se u razvoj vodikovih tehnologija ulažu veliki naponi, moglo bi ga biti teško implementirati u kratkom roku jer postoje tehničke i infrastrukturne prepreke u energetski intenzivnim primjenama. Iz perspektive industrijskih postrojenja, literatura prepoznaje vodikov potencijal u naporima da dekarbonizacije elektroenergetskog sustava. Može se proizvesti korištenjem viška proizvodnje električne energije ili potrošiti za proizvodnju električne i toplinske energije kada je to potrebno. Također funkcionira kao kratkoročno ili srednjoročno spremište energije. Budući da može manipulirati viškom i manjkom električne energije, pruža dodatnu fleksibilnost za balansiranje industrijskog sustava.

Prijašnji model industrijskog postrojenja prikazao je kako se boljim upravljanjem klasična industrijska postrojenja mogu integrirati na energetska tržišta. U novom modelu koncept proizvodnog procesa ostaje isti te se zamjenjuje dio koji koristi prirodni plin s vodikom te se uspoređuju ta dva postrojenja. U oba postrojenja je dodan sustav za proizvodnju električne energije iz fotonapona. Emisije iz industrijskog sustava mogu se podijeliti na izravne i neizravne. Izravne emisije nastaju lokalno u industrijskom postrojenju, dok su neizravne emisije rezultat proizvodnje električne energije u elektroenergetskom sustavu koji je postrojenje kupilo. Iako industrijsko postrojenje nije odgovorno za neizravne emisije, ono se ubraja u njihov ukupni ugljični otisak i povećava globalne emisije. Važno je uključiti i te emisije kako se proizvodnja emisija ne bi prenijela s lokalnih na globalne. Smanjenje ugljičnog otiska industrijskog postrojenja temeljenog na vodik u iznosi oko 40% kada sustav pokušava minimizirati troškove s mogućnošću gotovo potpunog smanjenja ugljičnog otiska. To znači da je ova vrsta sustava dovoljno fleksibilna da može raditi gotovo neovisno o ostatku elektroenergetskog sustava. Lokalne emisije su potpuno uklonjene što pozitivno utječe na zdravlje radnika i lokalnog stanovništva. Industrijsko postrojenje je međutim ekonomski vođeno, što znači da će njegovo ponašanje uvelike ovisiti

o troškovima. Provedena je analiza osjetljivosti sadašnjih, prošlih i budućih kretanja cijena električne energije i plina. Sustav temeljen na vodikom bio je lošiji u većem broju slučajeva od sustava temeljenog na plinu. Iako lošiji velike promjene cijena puno manje utječu na njegove ukupne troškove, što znači da se može lako prilagoditi različitim skupovima cijena. Važno je napomenuti da sustav u kojem su dodane nove tehnologije vodika iz literature u prosjeku ima manje troškove. Iz čega se zaključuje da će se u budućnosti značajno poboljšati potencijal industrijskih postrojenja temeljenih na vodikom ovisno o napretku tehnologije i o budućim kretanjima cijena. Vrijedno je napomenuti da će se cijene emisija vjerojatno rasti u budućnosti, čime će se vrijednost dekarbonizirana industrijska postrojenja značajno povećati. Također se očekuje smanjenje specifičnih emisija za proizvodnju električne energije s obzirom na dekarbonizaciju ostatka elektroenergetskog sustava.

Zaključno industrijska postrojenja pokazuju veliki potencijal za aktivno sudjelovanje na elektroenergetskom tržištu. U radu je istraženo njihovo natjecanje na dan unaprijed tržištu električne energije, program odziva potrošnje i suradnja više energijskih vektora koje postrojenja mogu koristiti kako bi smanjila svoje troškove. Cjenovna nesigurnost tržišta je također uzeta u obzir kako bi se dobili što realniji uvjeti rada postrojenja. Također je predložena zamjena prirodnog plina s vodikom i integracija obnovljivih izvora energije u svrhu smanjile emisije stakleničkih plinova koje ovakvo postrojenje proizvodi. Napravljena je analiza osjetljivosti s obzirom na potencijalna kretanja cijena električne energije i plina kako bi se usporedilo klasično postrojenje s postrojenjem baziranim na vodikom.

Ključne riječi: industrijsko postrojenje; tržište električne energije; odziv potrošnje; smanjenje emisija; vodikove tehnologije

Contents

- 1. Introduction 1**
 - 1.1. Background and Motivation 1
 - 1.2. Objective of the Thesis 1
 - 1.3. Structure of the Thesis 2

- 2. Industrial Prosumers as a flexibility provider 4**
 - 2.1. Energy-Intensive Industrial Prosumer 4
 - 2.2. Industrial Prosumer as a Demand Response Flexibility Provider 5
 - 2.3. Multi-Energy System Concept 8

- 3. Decarbonisation of Industrial Prosumer Using Hydrogen Technologies 10**
 - 3.1. Decarbonisation of Industrial Prosumer in the Power System 10
 - 3.2. Hydrogen Technologies Overview 12

- 4. Optimisation modelling 15**
 - 4.1. Mixed Integer Linear Programming 15
 - 4.2. Two-Stage Stochastic Model 17
 - 4.3. Robust Optimisation Model 18
 - 4.4. Indicator Constraint Linearisation 19

- 5. Main Scientific Contributions 21**
 - 5.1. Demand response and energy market modelling of multi-energy industrial consumer 21
 - 5.2. Decarbonisation Model of Multi-Energy Industrial Prosumer 22

- 6. List of Publications 24**
 - 6.1. Journal Papers 24
 - 6.1.1. Published 24
 - 6.2. International Conference Papers 25
 - 6.2.1. Presented and Published 25

6.3. National Conference Papers	25
6.3.1. Presented and Published	25
7. Author's Contribution to the Publications	26
8. Conclusion and Future Work	28
8.1. Conclusion of the Thesis	28
8.2. Future Work	29
Bibliography	30
Abbreviation	42
Publications	44
Biography	97
Životopis	98

Chapter 1

Introduction

1.1 Background and Motivation

In a traditional power system with centralised production and monopolistic utility companies, the end-users were passive consumers. With the paradigm change, they were given the possibility to become an active part of the power system through various methods. Industrial consumers are prime targets to employ these methods, making up around 25% [1] of the total primary consumption in the European Union. They are centralised, energy-intensive consumers who can act on their own without the need for aggregation with other consumers. Additionally, they have a high level of control and automation of their subsystems and utility devices [2]. Having high energy consumption they are responsible for large amounts of greenhouse gas emissions (GHG). Following the European Commission climate plan to lower emissions by at least 55% until 2030 [3] and emission allowances that will be forced on the industrial sector, it would be beneficial for them to act proactively and lower them. With the combined implementation of renewable energy sources (RES) and some energy storage systems, industrial facilities can achieve emission reduction while keeping the operational cost low [4]. They also have inherent flexibility through multiple local energy systems interactions, as shown in [5], and demand response techniques, [6]. Both can help industrial plants to adhere to their market-obligated exports and imports and to balance the intermittent and uncertain renewable generation. Hydrogen technologies have been shown to be adequate for electricity storage and heat production [7], thus making them compatible to support intermittent PV production. All of the above-mentioned concepts will be used to help industrial prosumers towards green energy transition.

1.2 Objective of the Thesis

The thesis will showcase the possibilities of industrial prosumers in the green energy transition and their integration into the wholesale energy market. The first part of the industrial prosumer

is modelled as a demand response entity where the schedule of its production chain is optimised. Each process in the production chain represents one or more consumption sectors. The second part of the model optimises utility devices which are used to satisfy the demand of the production chain. These two parts of the model complement each other, providing additional flexibility, since they can cover for each other shortcomings. Utility devices can utilize different energy sources to satisfy the plant's construction. Traditionally, energy sources were natural gas and/or electricity due to their availability and price. Most of the emissions are produced directly from fossil fuels used locally or indirectly from market-bought electricity. Considering emission fees/allowances that the industry will be responsible for (need to pay for), they are incentivised to lower them. Emissions can therefore be reduced in two ways. The first one is to replace the traditionally used fossil fuels with hydrogen, as hydrogen technologies have proven to be adequate from an operational standpoint. They can be used for electricity and heat production and as energy storage. The second way is the integration of renewable energy sources, such as photovoltaics (PV), to reduce the need for electricity import and provide assistance to hydrogen technologies. Electricity production from PV does not produce emissions, thus it reduces the carbon footprint of the plant.

In summary, the thesis will showcase possibilities of industrial prosumer utilizing flexibility from demand response and utility devices. It will also integrate an industrial plant onto the uncertain electricity market. Great emphasis will be placed on greenhouse gas emission reduction using hydrogen technologies and renewable energy sources to replace technologies based on fossil fuels.

Contribution of the thesis are as follows:

- Mathematical model of multi-energy industrial prosumer with process scheduling demand response considering uncertainty of energy market prices.
- Mathematical model of a decarbonised multi-energy industrial prosumer capturing values of energy interactions at different process stages.

1.3 Structure of the Thesis

The rest of the thesis is structured as following:

- Chapter 2 describes the industrial system from the power system perspective and gives an overview on demand response and multi-energy system techniques.
- Chapter 3 gives an overview on decarbonisation of power system and industrial prosumer and an overview on hydrogen technologies.
- Chapter 4 presents optimisation techniques used to analyse concept presented in this thesis.
- Chapter 5 highlights the main contributions presented in the thesis.

- Chapter 6 presents the list of all relevant publications.
- Chapter 7 summarises the author's contribution to the publications.
- Chapter 8 concludes the thesis and proposes the direction for future work.

Chapter 2

Industrial Prosumers as a flexibility provider

2.1 Energy-Intensive Industrial Prosumer

Industrial plants are very important entities in the power system and as such can effectively participate in various programs. Since they are energy intensive it might be beneficial for them to lower their operational costs by offering various products offered on the energy market. Although industrial facilities are important, the literature usually neglects them in favour of smaller end-users such as household level. It should be noted that market participation of small-scale end-users, such as households, is hindered by their small individual power and energy. Thus they need to be grouped with other entities through aggregators [8] into energy communities [9], virtual power plants [10] or some other similar entity. While industrial plants can be grouped with other entities, they can also have an impact on the power system operating individually [11]. Their operation is usually highly automatised [12] making it easier to perform various activities on the power market.

The main challenge with industrial prosumers is that they are complex, highly interconnected systems that are different from one another. Proper research needs to be conducted for each system to determine the parts that have flexibility potential [13]. There are various industries recognised and thoroughly analysed by different entities, such as the European Commission, for identifying the potential of introducing different demand-side management activities. The paper and pulp production industry [14] is dominated by heat consumption. The cement production industry [15] uses a lot of heavy machines for crushing raw materials and a kiln for heating the ingredients to high temperatures. The non-ferrous metals industry [16] mainly uses electrolysis consuming large amounts of electricity. The food production industry [17] is highly specific based on the product but usually contains heavy machinery. Chlor-alkali process industry [18] is also based on an electrolysis process to produce chlorine and sodium hydroxide

which can then be used in different processes. It also produces hydrogen as a side product which can be used for electricity or heat production. Steelmaking industry consumption [19] is dominated by the high heating needs used for smelting ore or scraps. It is usually produced in blast furnaces from fossil fuels (coal, oil or natural gas) or from electric arc furnaces and in smaller capacity from biofuels and waste [20]. Most of the consumption in aluminium production is tied to the electrolytic reduction process to separate aluminium from oxygen [21].

2.2 Industrial Prosumer as a Demand Response Flexibility Provider

The concept of the demand response (DR) is not new, but it gained in popularity owing to the changes that happened in the power system. Essentially in this program, the end-users can change their consumption pattern from the planned one in exchange for receiving certain benefits. Benefits are usually financial in nature, either through direct payments or through electricity cost reduction. From a System operator (SO) perspective, the DR provides additional flexibility that it can utilize instead of classic ancillary services [22]. This is further emphasised with the increase in renewable energy sources, which require more flexibility, as well as with the decrease in traditional electricity sources which provided the flexibility [23]. It can also be used for local purposes such as congestion management [24] or voltage regulation in distribution networks [25]. It is also used to balance the production and consumption of balance responsible parties [26]. Demand response usually does not require large investments, at least when compared to classical flexibility providers such as gas turbines. The analysis of the demand response potential in Germany showcased its possibilities under different scenarios [27]. In their most pessimistic scenario, it was concluded that the investments into the demand response are economically competitive to gas turbine installation. Industrial and commercial sectors were responsible for most of the demand response potential. Similar research was conducted for countries in Northern Europe where demand response potential from different sectors is analysed [28]. In total, demand response potential was found to be in the range of 15 to 29% share of peak load. Demand response flexibility from industry made up a 4 to 7% share of the peak load, while households made up for 5 to 13% share of the peak load. The household contribution was larger than that of the industry mainly due to high heating needs during cold weather periods in the observed countries (Sweden, Finland and Norway). The study also provided the remark that due to large amounts of flexible hydropower in the analysed countries, the demand response may not be strongly incentivised. The analysis of the demand response potential in Germany [29] found it to be a good successful assistance to classical flexibility providers with a shortcoming that it might not be readily available under certain conditions, seasons or times of the day e.g. high demand from air conditioning and air supply systems correlate with high

PV production. They found that it is important to recognise these conditions to improve the potential of the demand response. The study also analysed different sectors of consumption with a conclusion that the industrial sector should be the highest priority for demand response, due to lower costs of implementation and better response.

Usually in the literature, the DR is divided into price-based and incentive-based [30]. With an incentive-based DR program, the flexibility provider is invited to perform the service by the third party, be it the SO or another balancing responsible party, and receives benefits for it [31]. This DR activation can be automated to trigger when the outer signal is sent and the right conditions are met (usually set by the DR provider) [32]. The best example would be thermostatically controlled type units (refrigerators, air-conditioners, space heaters, etc.) that can lower or increase their power automatically on demand while remaining between predefined temperature limits set by the DR provider [33]. In a price-based DR program, the end-users schedule or change their production based on the price impulse [34]. Prices that the end-user receives can come from different sources like day-ahead market [35] or from an aggregator or supplier in terms of time-varying tariffs [36]. The paper [37] proposes a multiple pricing approach to groups of end-users clustered together. It considers different patterns among end-users and behaviour changes so that it can offer the right price for the right consumer. The bidirectional interaction between the power grid and end-user (building) responding to dynamic pricing is showcased using game theory in [38]. The goal of the power grid is to reduce demand fluctuations while the end-user is trying to lower its overall costs. The methodology was tested on a campus building in Hong Kong where this interaction managed to lower the demand fluctuation by about 40% while lowering the electricity cost of the end-user by 2.5–8.3%. The thermal capacity of a building can be used to provide DR services through heating, ventilating, and air-conditioning (HVAC) units as is showcased in [39]. The important aspect of this DR approach is to lower discomfort for users i.e. that each user can define a satisfactory range of temperature. User discomfort and loss of consumption are an important part of the DR since they can make DR worth less. User discomfort is usually harder to quantify thus making it prevalent in literature. The paper [40] presents an algorithm for cost-comfort tradeoff so that it can improve household automated price-responsive DR. Loss of consumption or load shedding can lead to major losses for certain end-users (e.g. Industrial plants) making it less viable for them to participate in DR program. The load-shifting method is often used to circumvent loss of production. With it, the end-user would ideally move the load to a more favourable time thus providing demand response while keeping its consumption at the same volume [41]. Unfortunately, it might be impossible to shift all consumption, leading to potential losses in revenue that need to be accounted for when calculating profitability. Paper [42] showcased the possibilities to earn profit from load shifting in real-time energy market utilising by solving a finite-horizon Markov decision process problem. In conclusion, this research managed to increase its profit

by 55% when compared to a benchmark problem.

The literature usually places industrial plants as pivotal in the integration of demand response to the power system. Although important, they are usually neglected in most literature in favour of consumers from other sectors [43]. In [44] the authors concluded that the industries are technically more than capable of providing demand response services, but are lacking from a regulatory and economic standpoint. The solution from their point of view would entail that market rules be adjusted towards easier demand response provision and provide enough incentive for both demand response providers and system operator. Paper [45] provides insightful challenges and barriers for industrial demand response based on the market, technological, social and regulation aspects. From the market perspective, the main barriers include incomplete and uncompetitive markets, lack of data which might not be cost-effective to collect and uncertainties in the market that can hinder participation. From the social perspective, the participants might be unwilling to make necessary investments or blindly accept equipment provided to them as a means of incentive. Additionally, loss of comfort and production is a major concern for industrial consumers. Technological barriers can include any technology, skill or knowledge needed to properly participate in the demand response programs. From the regulatory perspective, most of the policies in the existing power systems are still based on large-scale generators leaving less room for adequate participation in demand response. Similarly [46] provides an outlook about key issues considering demand response application of multi-energy industrial parks. From their point of view, more effort should be placed on research that takes into account both the supply and the demand side. Also, they have noted that most of the research in the literature observes short-term benefits of demand response while neglecting medium/long-term demand response. From the market perspective, they think that more policies and funds should be developed to incentivise industries to participate in demand response programs. From their analysis, demand response has better potential when combined with other energy vectors, as it can switch when needed. This leads to the improvements in comfort index on which they place major concerns.

The methodology for industrial demand response is based on batch process scheduling and is presented in [47]. The paper considers different scenarios, including renewable energy sources (RES) and battery storage systems (BSS). Demand response is modelled as a price-responsive based on different smart pricing schemes such as day-ahead pricing, time-of-use pricing, peak pricing, inclining block rates and critical peak pricing. A similar, albeit a bit simplified, model is adapted to a real-world industrial plant by the same authors in [48]. Huang et. al. [49] provide the optimisation framework based on a price-based demand response of steel powder manufacturing. Real-time prices are considered to be unknown beforehand, thus requiring forecasting in the form of artificial neural networks which are then integrated into the optimisation model. Their results have shown that this combination managed to balance energy demand and

reduce costs while satisfying production targets. The possibilities of demand response in metal casting industries are presented in [?], based on the minimisation of operation costs on a day-ahead market while maximising reserve provision when participating in the ancillary services market. Mixed-integer programming approach is used incorporating manufacturing constraints and market requirements. Helin et. al. [50] showcased the economic benefits of pulp and paper industries operating in the Nordic intra-day power market while considering original production optimised gains based on spot price forecasts. They found that in most studies technical or theoretical viewpoints are addressed more often than economical, which they find crucial for any energy-intensive industry to consider participating in any form of flexibility program. A case study for day-ahead scheduling with real-time demand response management in the chlor-alkali production industry is proposed in [51]. The system also contains photovoltaic thermal systems, wind energy conversion systems and fuel cells. Demand response is based on a contract and incentive-based scheme.

2.3 Multi-Energy System Concept

The multi-energy system is a type of system that contains different energy vectors that can cooperate together and complement each other by shifting between one another or by storing energy in different forms for later use. Shifting between energy vectors is usually done as a response to outside signals, e.g. the system will switch to local electricity production during times of high electricity prices. Additionally, this type of system can provide flexibility services to the system operator [52]. Conceptually, multi-energy systems are very similar to the demand response concept as they both provide internal flexibility to the system. Unlike demand response, the multi-energy system will not have production losses since its consumption will be satisfied through different energy vectors. It is only affected by the efficiencies when switching between energy vectors. They can also be used simultaneously to complement each other [53]. The optimisation model where a multi-energy system comprised of consumers and combined cooling heating and power plant is proposed in [54]. Demand response is utilised to adjust electricity, heating and cooling consumption that the users can have. Similar to demand response, it can also be a great tool in the transition towards a decarbonised power system [55]. It can be used to mitigate uncertain production of wind and solar production as presented in [56]. The paper uses adaptive robust optimisation for scheduling multi-energy microgrids considering different time scales. Different layouts of multi-energy microgrids are presented in [57]. The operation is considered in grid-connected mode and isolation mode. Multi-energy flexibility is used to compensate for renewable energy generation, and demand and adhere to contractual electricity import/export. It is also used to balance the microgrid in isolation mode. Electric vehicle integration in multi-energy systems is presented in [58]. Features of the multi-energy system

are modelled by considering combined heat and power generation, thermal energy storage, and auxiliary boilers along with price-based and incentive-based demand response. A case study on a real-life multi-energy building is presented in [59]. The optimisation is presented in two steps: the first step roughly scheduling the building and the second stage is online convex optimization used to track in real-time the objective set by the scheduling level. The authors demonstrate achieving net positive revenue and satisfy all constraints 97.32% of the time. The multi-energy system concept is not only applicable to end-users. Some research is proposing the creation of hybrid energy systems. Such a system is proposed in [60] where electricity, gas and thermal grid are considered working together. They also note that the change to the hybrid system would bring adjustments in the energy infrastructure, transformation technologies, energy system modelling, planning and economic frameworks, which can lead to high investment costs and needs to be justified considering cost savings. Authors in [61] provide a comprehensive review of different energy networks focusing on interactions and interdependencies between multi-energy networks to ease their integration together.

Chapter 3

Decarbonisation of Industrial Prosumer Using Hydrogen Technologies

3.1 Decarbonisation of Industrial Prosumer in the Power System

In an effort to reduce the negative effects of climate change, many countries have agreed to implement policies for the reduction of greenhouse gas emissions through various international, national or local agreements, starting with the Kyoto Protocol from 1997 [62] and continuing with Paris agreement from 2016 [63]. At the forefront is the European Union with its own set of policies aiming to reach climate neutrality by the year 2050 through European Green Deal [64] with an earlier goal to achieve 55% less net greenhouse gas emissions by 2030, compared to 1990 levels through fit for 55 package [3]. Clean energy for all Europeans package [65] is focused on decarbonisation of energy system through energy efficiency, renewable energy sources, governance regulation and other non-legislative initiatives. From the perspective of industrial plants, they will receive free allowances to emit greenhouse gases based on the 10% best-performing installations for certain products [66]. Methodology does not take into account technology or fuel used meaning that the industrial facility that does not reach the 10% benchmark will receive fewer allowances than it needs and will have to reduce its emissions or buy additional allowances. It is expected that for less exposed sectors, the free allowances will not be allocated by 2023, meaning that industrial plants will have to buy all of their emissions.

With these policies in mind, all levels of the power system have gone through great changes in order to adapt to the above requirements. Renewable energy sources, such as photovoltaic and wind power plants, are major players in this transition. Traditional power plants with high emissions, utilizing fossil fuels, are slowly being replaced with green technologies on both system and local levels. The paper [67] has presented an economically viable 100% renewable

system for Germany to maximally reduce greenhouse gas emissions. On a local scale 362 European cities were analyzed in [68] based on their preparedness to become climate-neutral. The research showed that although policies and incentives are being employed, efforts should be intensified to reach this goal, especially in terms of energy storage integration. The project [69] proposes innovative energy management solutions for the integration of distributed renewable energy sources and storage technologies in order to help speed up the decarbonisation of the power system. The transport system is another major sector that is going through a similar transition. The main way for it is through a combination of electric vehicles and renewable energy sources, making them emission-free [70]. Demand response is also an important technique that is expected to assist renewable energy sources in efforts to decarbonise the power system [71], as it has the capability to mitigate the negative effects of uncertainty renewable energy production. Demand response is covered in more detail in chapter 2.2. Mitigation of local emissions should also be the focus, even if they are only transferred to the global level. Their reduction has a positive impact on the health of the local population and workers in the case of industrial facilities [72]. Considering only expected CO_2 emissions reduction, hundreds of millions of fewer premature deaths worldwide could be mitigated as reported in [73].

Industrial facilities are also part of the green energy transition. Their decarbonisation can be approached from multiple angles. Some of them are as follows: from the energy efficiency angle, better resource efficiency, better utilisation of byproducts, production process optimisation, fossil fuel substitution, renewable energy sources integration and facility electrification. This thesis will focus on some of these concepts; mainly production process optimisation, fossil fuel substitution and renewable energy sources integration. Other concepts are not captured by this work, mainly because they are usually specific based on the type of industrial process and final product. Renewable energy generation is usually considered for integration in industrial facilities as presented by [74]. In the paper, an investment analysis of photovoltaic and battery storage system is provided, in order to reduce energy costs of a generic industrial facility. With the higher flexibility system, the industry facility can lower its emissions by being less dependent on the electricity import. The paper and pulp industry is one of the top five most energy-intensive industries. This type of industry has great potential for decarbonisation from raw material to production, transport and waste recycling [75]. Main decarbonisation techniques would entail better forestation policies during the raw material gathering, process optimisation, electrification and substitution of outdated technologies during the production process. Transportation is a major issue which would require the substitution of fossil fuels to decarbonise. The paper additionally puts great emphasis on recycling as a means of reaching net-zero production and forest conservation. The main barriers that the authors have recognised are economic, lack of information and knowledge sharing and lack of staff training. The cement industry is another major CO_2 producer. The problem with this industry is that most of the emissions are

produced by the production process (kilning) and not by energy use [76]. The main barriers to decarbonisation are lack of awareness, aversion to adopting of new technologies and inertia in construction regulations [77]. The ceramics industry is another energy-intensive high-emission industry [78]. The authors of the paper recognised that the main decarbonisation path is electrification and biofuel utilisation and that the main barriers are economic, lack of knowledge and incentives/regulation for smaller facilities. The analysis of the lime production industry has shown that although a lot can be done to decarbonise it, the main path would be to create innovative alternative routes for cold/no-combustion decarbonisation of $CaCO_3$ [79]. The steel-making industry is usually based on coal burning and the efforts to decarbonise are being made by switching to green alternatives like electricity and hydrogen. Authors from [80] have conducted the analysis of countries ready to perform this transition with a conclusion that only EU countries are ready for it. Other countries either do not show a strong commitment to the energy transition, are technologically behind or lag behind in the implementation of low-carbon production electricity technologies.

3.2 Hydrogen Technologies Overview

Following the efforts to reduce greenhouse gas emissions, hydrogen is considered as an energy vector to partially replace fossil fuels [81]. Hydrogen technologies are not a new concept but their research has gained traction with new incentives on a global scale [82]. According to their prediction around 60% of all greenhouse gas emission reduction will come from renewable energy sources, green hydrogen and low carbon electrification. The main benefit of hydrogen is that it is very versatile and can be used to cover energy demand in a variety of different applications in the power system. It also does not produce any local emissions and if produced from clean electricity (e.g. renewable energy sources) can be considered emission-free [83]. Although great effort is placed on hydrogen it might be difficult to implement in the short-term as there are technical and infrastructure barriers in large-scale application [84]. From the perspective of industrial facilities, the literature recognises hydrogen potential in efforts to decarbonise the industrial sector. Green hydrogen industrial application potential is presented in [85].

Hydrogen production from renewable and non-renewable energy sources is analysed in [86]. Fossil fuel hydrogen production is taken as a benchmark to compare with other technologies as it is the most reliable and commercialized. Biomass and water-based production of hydrogen yielded approximately similar results as fossil fuel hydrogen production, while the production of hydrogen with renewable energy sources had limitations on the commercialization front. The main barriers that the authors have recognised are technological, lack of transport, investment risk and lack of international standards, though they believe that through technological devel-

opment and with a rise in economic viability these barriers will be solved. Even though, there are challenges to the integration of hydrogen production from renewable energy sources they are not neglected in the literature. Hydrogen as an energy storage is also an important topic as it is highly effective short/medium-term storage [87]. Different types of hydrogen storage are presented in [88], from physical and chemical types of storage. From there, the analysis of the underground hydrogen compressed air storage had the best results and has shown the biggest potential. The authors from [89] also advocate for underground hydrogen storage as the best future technology. Hydrogen storage is also usually coupled with renewable energy sources in order to cover for their intermittent and uncertain nature [90]. Integration of hydrogen in the literature is considered in many different systems. Long-term hydrogen storage is proposed in a microgrid with 100% renewable energy generation [91]. The paper provides the methodology for operation and for finding the best sizing values for such a system. Hydrogen storage is considered in industrial facilities as well, usually as a substitution for coal or gas as is the case for the steel industry [92]. A comprehensive review of possibilities of hydrogen integration in the iron and steel industry is presented in [93]. Their analysis showed that hydrogen metallurgical transition could reduce CO_2 emissions by 62.53% in 2050 when compared to 2020. The paper also notes that this will mostly depend on economic factors and future technologies. It is also utilised in some industrial processes meaning that they already have means of hydrogen production making investment costs lower [94]. Heat production from hydrogen is another important research topic. The possibilities of green hydrogen in heat production are examined by Samastil et. al. [95] in order to decarbonise the heat demand sector in Great Britain. Their results have shown that there is potential for 20% of heat production from hydrogen. From the perspective of the power system, hydrogen can be used as a flexibility service provider. The paper [96] discusses the integration of power to hydrogen and heat with seasonal hydrogen storage in a system with very high renewable energy penetration. The flexibility of the hydrogen system is used to cover generation-load uncertainties and N-1 contingency of crucial devices. The flexibility of hydrogen can also be used for profit maximisation in the day-ahead electricity market. This concept is presented by Miljan et. al. [97], who propose day-ahead electricity market participation of a large-scale battery storage system and electrolyser while simulating market clearing in a bilevel model. The paper analysed profits and utilisation for different sets of installed power capacities of devices. Most of the above-mentioned literature focuses on the local production of hydrogen since transportation and procurement of hydrogen have still not been adequately solved. Some of the prominent solutions suggest using the natural gas grid for hydrogen transportation [98]. With this transportation solution, the hydrogen market could be made to follow natural gas market mechanisms. Pavic et. al. [99] consider a multi-market environment where natural gas, electricity and hydrogen can be procured, while also providing ancillary services for the system operator in the form of automatic frequency restoration reserve. The proposed

system is comprised of hydrogen technologies, renewable energy sources and a battery storage system. With this or similar changes, hydrogen could improve economically and become much more interesting for investors.

Chapter 4

Optimisation modelling

To showcase the ideas presented in this thesis we have utilised methods from operational research discipline. This discipline combines techniques from different fields of mathematical sciences such as modelling, statistics, and optimization. Operational research is conceived as an analytic method to improve the decision-making process. The sub-discipline of operational research that was used, combines mathematical modelling in combination with optimisation where the model is solved to reach the global optimum for the given objective function and corresponding constraints. There are a lot of sub-fields of optimisation based on the modelling complexity, requirements and data availability of the given problem. Our models fall into the sphere of convex programming where the objective function is either convex or concave for minimisation or maximisation respectively over a convex set of constraints. Types of convex programming are but are not limited to:

- Linear programming (LP)
- Second-order cone programming (SOCP)
- Semidefinite programming (SDP)
- Conic programming
- Geometric programming

Our specific model belongs to a subgroup of linear programs called Mixed-integer linear programs. Two of the models belong to two other subgroups of linear programs that are designed to deal with uncertain parameters called: Two-stage stochastic and robust optimisation mixed-integer linear programs.

4.1 Mixed Integer Linear Programming

From the historical perspective, many people have tried to efficiently solve this type of problem like Jean-Baptiste Joseph Fourier in 1827, Leonid Kantorovich in 1939 and Frank Lauren Hitchcock in 1941. The most notable breakthrough came with George B. Dantzig who, in

1947, developed a general linear programming formulation and invented the simplex method that could solve these problems in almost all cases. The computational time for this algorithm was proved to be in polynomial time. Another notable solver technique came with Narendra Karmarkar in 1984 who introduced the Interior-point method. In modern solvers, these methods were improved upon with many different techniques to accelerate the time needed to solve these problems. Mixed-integer linear programs are solved with above mention techniques with the addition of a branch and bound (branch and cut) technique. This method breaks the main problem into sub-problems that form a root tree which is searched for optimal solution while discarding those that do not produce better solution than the current best. Although linear optimisation is solved in polynomial time, the addition of branch and bound methods makes the problem NP-hard (non-deterministic polynomial-time hardness). They are harder to solve, but they greatly improve the possibility of modelling.

Linear optimisation models mandate that all constraints and objective functions are linear i.e. there are no multiplications of any two variables and that all variables are continuous non-negative. Their main strengths are being easier to solve than more complex models, as mentioned above. Additionally, they are exact models that are always guaranteed to reach the global optimum of any given problem. Their flaws are that more complex problems are not able to be written in this form or that they require major assumptions which deviate the problem solution from the proper solution. The standard form of a linear model in matrix form is shown in expressions (4.1)-(4.3), where x is a variable matrix and C , A and b are objective function, left-hand side and right-hand side matrices respectively. The objective function (4.1) is subjected to a set of (4.2) while all variables are continuous and non-negative (4.3).

$$\max C^T x \tag{4.1}$$

$$\text{s.t. } Ax \leq b \tag{4.2}$$

$$x \geq 0, \quad x \in X \tag{4.3}$$

Linear models are expanded into mixed integer linear models when one or more variables are not continuous but are rather an integer number i.e. takes the value of the whole number $x \in \{0, 1, 2, 3, 4, \dots\}$. A special subset of integer variables are binary variables that must always take on the following two values $x \in \{0, 1\}$. These are the most used type of integer variables as they can adequately model different states of certain processes.

4.2 Two-Stage Stochastic Model

This subsection describes the models used when some of the parameters are uncertain or are not exactly known. Uncertain parameters are usually predicted using techniques from statistical analysis. The analysis will usually provide a distribution function for an uncertain parameter which is then discretized based on their probability of occurrence to create uncertain scenarios which can be used in optimisation. The sum of all probabilities of occurrence must be equal to 1 (100%). Each scenario represents the possible realization of an uncertain parameter. Two-stage stochastic model will then take into account all scenarios to solve the model. The model is made of two stages. In the first-stage, the decision must be made before the realisation of uncertainty and in the second-stage, we optimize the behaviour after the realisation of uncertainty. The model recognises the first-stage variables (here-and-now) and the second-stage variables (wait-and-see). The results of first-stage variables must be the same for each scenario while taking into account possible realizations of all scenarios. The second-stage variables are scenario-specific and are calculated separately based on the results of first-stage variables and the realization of stochastic parameters. Every second-stage variable that contributes to the objective function is multiplied by the probability of occurrence of the scenario that it is defined for. When compared with the deterministic model, this model will have N times more variables, that are recognised as second-stage, where N is the number of scenarios. Additionally, every constraint must be written for each uncertain scenario unless it only contains first-stage variables and no stochastic scenarios. This will multiply the number of constraints by N where N is a number of scenarios. For this reason, two-stage stochastic models can be computationally much harder to solve, especially if a large number of scenarios are used. The standard form for this model is very similar to the one shown in section 4.1 with additions mentioned in this section. The standard model is shown in (4.4)-(4.7), where x denotes first-stage variables, y_ω denotes second-stage variables, C , Q , T , W and H denotes parameter matrices and λ_ω probability of occurrence. Equation (4.5) shows constraints that do not have any second-stage variable or stochastic scenario and are thus written only once. On the other hand, equation (4.6) shows constraints that must be repeated for every stochastic scenario. The results of the objective function represent expected results, based on all scenarios, while the real result will depend on the actual realization of uncertain parameter. This kind of model is by its nature risk-averse because it does not take into account any of the user's preferences (e.g. willingness to take an option with lower possibility but higher profit potential). Please take into account that such behaviour of modelling is possible but is out of the scope of this research. The flaw of these models, apart from computational time, is they are very dependent on the quality of uncertain parameter prediction and can yield bad results if the actual realization of uncertain parameters is not accounted for.

$$\min C^T x + \sum_{\omega \in \Omega} Q_\omega^T y_\omega \lambda_\omega \quad (4.4)$$

$$A x = b \quad (4.5)$$

$$T_{\omega} x + W_{\omega} y_{\omega} = H_{\omega}, \quad \forall \omega \in \Omega \quad (4.6)$$

$$x \in X, \quad y_{\omega} \in Y, \quad \forall \omega \in \Omega \quad (4.7)$$

4.3 Robust Optimisation Model

Robust optimisation is another model that deals with uncertain parameters. It also requires that uncertain parameter is predicted using some other technique. An uncertain parameter, known as a robust set, is modelled as a deviation of the parameter for its reference value in both directions, usually symmetrically. An example of the robust set is shown in (4.8) where u is the uncertain parameter, u_{ref} the reference value and Δ deviation from the reference value. The uncertain parameter can take any value in this interval. Unlike the model from section 4.2, the robust model does not consider any probability of occurrence but rather considers that every realization of the robust set has the same probability. The robust optimisation model will solve the problem based on the worst possible realization of uncertain parameters while being feasible on the whole interval. The standard model is shown in the matrix form in equations (4.9)-(4.11), where x denotes variables, u denotes robust set and A and B matrices parameters of the model. As it is seen in the objective function (4.9), the variables x are minimised for the maximum (worst-case) value of u . Since this model in its nature considered as a worst-case scenario, it can be considered quite conservative with results. It can skew the results too much towards the worst-case so the results can be much worse in case of different realisations. The model is usually better suited for complex technical systems where worst-case scenarios can lead to system failure. To reduce the conservativeness of the results we introduce the budget of uncertainty (4.12), where " Γ " denotes the defined budget of uncertainty. The budget of uncertainty sets the amount of deviation that is allowed for the whole robust set. The value of the uncertainty budget is between 0% and 100%, where 0% means that no deviation is allowed so the robust set will take on reference value and 100% means that the robust set will take on worst-case value. For values in between robust set will have worst-case results for the allowed deviation.

$$u \in [u_{ref} - \Delta, u_{ref} + \Delta] \quad (4.8)$$

$$\min_{x \in X} \max_{u \in U} u^T x \quad (4.9)$$

$$A x = B \quad (4.10)$$

$$x \geq 0, \quad x \in X \quad (4.11)$$

$$\sum_{u \in U} \frac{|u - u_{ref}|}{\Delta} \leq \Gamma \quad (4.12)$$

In this form, the model cannot be solved using conventional solvers. The duality theorem needs to be used to linearise this problem. The duality theorem states that any optimisation problem can be viewed from a primal and dual perspective. If the primal problem is minimisation then the dual problem should be maximisation. The strong duality theorem states that if the primal problem has a feasible solution then the dual problem must have a feasible solution, and both results of the objective functions should be identical. In our case, if we change the inner maximisation problem to its dual problem maximisation will be changed to minimisation which then changes the min-max problem to just minimisation. Since variables in the inner maximisation problem are only the robust set meaning that only constraints with them should be transformed. This also solves the multiplication of x and u variables from the original objective function. The inner maximisation problem contains only non-negative continuous variables meaning that dual transformation is trivial to perform using a primal-dual transformation table. Absolute value from uncertainty budget constraint (4.12) is transformed into constraints (4.13)-(4.15). The dual formulation of this problem is shown in (4.16)-(4.18), where $\lambda^1 - \lambda^5$ denotes new variables in the dual formulation. As it can be seen from given constraints all multiplication of variables is removed making the model linear. This dual model is then integrated with the outer minimisation part of the model adding the rest of the objective function and constraints in their original form.

$$\frac{u - u_{ref}}{\Delta} \leq \gamma_k, \quad \forall u \in U \quad (4.13)$$

$$-\frac{u - u_{ref}}{\Delta} \leq \gamma_k, \quad \forall u \in U \quad (4.14)$$

$$\sum_{u \in U} \gamma_k \leq \Gamma \quad (4.15)$$

$$\min \Gamma \lambda^5 + \sum_{u \in U} (u_{ref} + \Delta) \lambda^1 - \sum_{u \in U} (u_{ref} - \Delta) \lambda^2 + \sum_{u \in U} u_{ref} (\lambda^3 - \lambda^4) \quad (4.16)$$

$$\lambda^1 - \lambda^2 + \lambda^3 - \lambda^4 \geq x, \quad \forall u \in U \quad (4.17)$$

$$-\Delta \lambda^3 - \Delta \lambda^4 + \lambda^5 \geq 0, \quad \forall u \in U \quad (4.18)$$

4.4 Indicator Constraint Linearisation

Indicator constraints are special types of constraints that are implemented in certain solvers like Gurobi [100]. These are if-then constraints shown in (4.19), where if the state of binary variable

(x) is true then constraints on the right must be enforced and if x is not true then the constraint is neglected from the model. The mathematical model of this constraint is shown in (4.20) which is not linear because it contains a multiplication of continuous and binary variables. Their linear form is written using big M , where M is a big enough number that must be determined by the user's upper/lower limit that the user knows will never be surpassed (for all intents and purposes M should impersonate +/- infinity). When there is inequality on the right-hand side the expression goes as follows 4.21. In the case of equality constraint on the right side (4.22), the linearised formulation is created with two opposite inequality constraints in (4.23) and (4.24).

$$x = 1 \rightarrow Ay \leq B \quad (4.19)$$

$$A y x \leq B \quad (4.20)$$

$$A \cdot y \leq B + M(1 - x) \quad (4.21)$$

$$x = 1 \rightarrow A y = B \quad (4.22)$$

$$A y \leq B + M(1 - x) \quad (4.23)$$

$$A y \geq B - M(1 - x) \quad (4.24)$$

Chapter 5

Main Scientific Contributions

The main scientific contributions of this thesis are separated into two parts. Both contributions deal with energy-intensive industrial prosumers in the green energy transition. The first part deals with the modelling of process scheduling demand response and integration in the energy market. The second part covers the reduction of greenhouse gas emissions and carbon footprint for industrial prosumers. Decarbonisation is conducted through various different techniques, such as the integration of renewable energy sources, the introduction of hydrogen technologies as a substitute for fossil fuels and the utilization of local flexibility for better management of electricity.

5.1 Demand response and energy market modelling of multi-energy industrial consumer

With the changes in the power system, end-users are placed at the forefront. Traditionally passive participants can now participate in several different programs to provide services to system operators or better manage their energy consumption. There are also incentives for local green electricity production. Industrial facilities are energy-intensive energy consumers and as individuals have a higher impact on the power system. They can actively participate in the electricity market, though it can lead to penalties if they deviate from their planned consumption/production pattern. To circumnavigate these penalties and better adjust to market conditions they can utilise internal flexibility. Flexibility can be gained from multiple sources. Industrial facilities are considered multi-energy systems, which means that they operate with multiple energy vectors simultaneously. These energy vectors can interact with each other by transforming from one to another or storing them to be used later. Switching from one energy vector to another can be beneficial if the cost of one is high. Multi-energy industrial prosumer model operating under uncertain day-ahead market conditions is presented in [P₄]. It also pays prices based on secondary regulation prices for deviating from its planned consumption/production.

The market model is set as a two-stage stochastic model with uncertain electricity prices. The model is improved in [P₁] with the introduction of demand response. The demand response is a program where the users can change their consumption patterns based on direct incentives or on outside signals. The production process chain of the industrial prosumer is modelled as a price-responsive demand response. The industrial prosumer must produce the desired amount of the end product but it can shift production throughout the optimisation horizon. The model is created as both a two-stage stochastic and a robust model. The robust model was deemed better both from the result and computational perspective. The analysis showed that the demand response had a bigger impact than multi-energy although its impact should not be neglected. The active market participation and utilization of different flexibility options yielded better results than the passive business-as-usual approach.

5.2 Decarbonisation Model of Multi-Energy Industrial Prosumer

In order to mitigate the negative effects of climate change a lot of effort is placed on emissions reduction on all levels in the power system. End-users are also part of this transition usually employing local renewable energy systems and decarbonising their heating. Industrial prosumers are special types of end-users that need to buy emissions allowances for emissions that they produce directly, making it a good incentive to lower them. Additionally, there are indirect emissions produced by buying electricity from the market. As mentioned before, renewable energy sources are a good way to lower emissions as they produce clean electricity. Their major flaw is intermittent nature and unpredictable production making it difficult to adhere to its planned consumption curve in order to bypass imbalance penalties. Internal flexibility can be very helpful in balancing the system as is explained in the previous section 5.1. Another decarbonisation technique is to replace locally consumed fossil fuels. Hydrogen as an energy vector, has been proven as a promising replacement. It can be produced using excess electricity production or consumed for electricity and heat production when needed. It also functions as a short or medium-term energy storage. Since it can manipulate deficit and surplus electricity it provides additional flexibility for balancing the industrial system. Possibilities of hydrogen as an energy vector are showcased in [P₃] and [P₅] and compared with different concept systems, gas-based traditional systems and fully electrified systems. From a purely economic perspective, hydrogen was shown as the worst option but it showed great promise from the flexibility and emission reduction. Emissions from the industrial system are separated into direct and indirect. Direct emissions are produced locally in the industrial facility, while indirect emissions are the result of electricity production in the power system that the facility has imported. Although industrial facilities are not directly responsible for indirect emissions it counts towards their

overall carbon footprint and global emissions. It is important to also include these emissions so that local emissions are not only transferred to indirect emissions. The hydrogen system is integrated into industrial prosumer alongside photovoltaic system [P₂]. Hydrogen technologies include electrolyser for hydrogen production, hydrogen storage and fuel cell for electricity and heat production. On baseline carbon footprint reduction of hydrogen-based industrial plants is around 40% with the possibility of almost completely reducing its carbon footprint. Meaning that this type of system is flexible enough so that it can operate almost independently from the rest of the system. Local emissions are completely removed which has a positive impact on the health of workers and the local populace. Industrial facility is however economically driven meaning that its behaviour will largely depend on it. The sensitivity analysis of current, past and future price trends of electricity and gas was conducted. The hydrogen-based system performed worse in more cases than the gas-based system. Although worse large price changes affect its total costs much less, meaning it can easily adapt to different price sets. It is important to note that the system in which the new hydrogen technologies from the literature are added has lower costs on average. This means that with the progress of technology and depending on future price trends hydrogen-based industrial facilities show significant potential to become leading technology. It is worth noting that the emissions prices will likely change in the future which can help hydrogen-based industrial facilities to become more profitable. Also, it is expected that the specific emissions for electricity production will decrease as the whole power system is being decarbonised.

Chapter 6

List of Publications

Relevant publications that cover the main contributions of this paper are shown in this chapter. They cover the modelling of industrial prosumers considering demand response process scheduling, multi-energy aspect and the uncertain nature of the energy market. Other main topics cover decarbonisation techniques mainly achieved by utilizing hydrogen technologies as a replacement for traditional fossil fuels. Other papers that are not mentioned in this chapter are loosely based on this topic and can be found under the author's biography. Papers from the domestic conferences are also omitted.

6.1 Journal Papers

6.1.1 Published

- [P₁] M. Kostelac, I. Pavić, N. Zhang, T. Capuder, "Uncertainty modelling of an industry facility as a multi-energy demand response provider," *Applied Energy*, Volume 307, 2022, 118215, ISSN 0306-2619, doi: 10.1016/j.apenergy.2021.118215
- [P₂] M. Kostelac, I. Pavić, T. Capuder, "Economic and environmental valuation of green hydrogen decarbonisation process for price responsive multi-energy industry prosumer," *Applied Energy*, Volume 347, 2023, 121484, ISSN 0306-2619, doi: 10.1016/j.apenergy.2023.121484
- [P₃] M. Kostelac, L. Herenčić, and T. Capuder, "Planning and Operational Aspects of Individual and Clustered Multi-Energy Microgrid Options," *Energies*, vol. 15, no. 4, p. 1317, Feb. 2022, doi: 10.3390/en15041317

6.2 International Conference Papers

6.2.1 Presented and Published

- [P₄] M. Kostelac, I. Pavić and T. Capuder, "Mathematical model of flexible multi-energy industrial prosumer under uncertainty," 2020 International Conference on Smart Energy Systems and Technologies (SEST), Istanbul, Turkey, 2020, pp. 1-6,
doi: 10.1109/SEST48500.2020.9203240
- [P₅] M. Kostelac, L. Herenčić and T. Capuder, "Optimal Cooperative Scheduling of Multi-Energy Microgrids Under Uncertainty," 2021 International Conference on Smart Energy Systems and Technologies (SEST), Vaasa, Finland, 2021, pp. 1-6,
doi: 10.1109/SEST50973.2021.9543123

6.3 National Conference Papers

6.3.1 Presented and Published

- [P₆] M. Kostelac, I. Pavić, T. Capuder, "Integracija vodikovih tehnologija u višeenergijska industrijska postrojenja", 15. savjetovanje HRO CIGRE, Šibenik, Hrvatska, 2023. str. 1-10 (predavanje, domaća recenzija, cjeloviti rad (in extenso), znanstveni)

Chapter 7

Author's Contribution to the Publications

The contributions of the thesis have been accomplished between 2020 and 2023 at the University of Zagreb Faculty of Electrical Engineering and Computing, Unska 3, HR-10000 Zagreb, Croatia. The research was conducted while working on the following projects:

- Project Innovative Modelling and Laboratory Tested Solutions for Next Generation of Distribution Networks (IMAGINE), co-funded by the Croatian Science Foundation (HRZZ) and Croatian Distribution System Operator (HEP-Operator distribucijskog sustava d.o.o.) under grant agreement PAR-2018
- Project Connected Stationary Battery Energy Storage (USBSE), funded by the European Union through the European Regional Development Fund Operational Programme Competitiveness and Cohesion 2014-2020 of the Republic of Croatia under project under grant agreement KK.01.1.1.04.0034

The main contribution in every paper from the list presented in Chapter 6 is given below:

- [P₁] In the published journal paper "*Uncertainty modelling of an industry facility as a multi-energy demand response provider*": literature review, definition and implementation of two-stage stochastic and robust model based on a price-responsive demand response and market participation of multi-energy industrial prosumer, comparison with passive business-as-usual model.
- [P₂] In the published journal paper "*Economic and environmental valuation of green hydrogen decarbonisation process for price responsive multi-energy industry prosumer*": literature review, defining and formulating a mathematical and optimisation hydrogen-based industry facility layout model, emission and sensitivity analysis compared to classic gas-based system.
- [P₃] In the published journal paper "*Planning and Operational Aspects of Individual and Clustered Multi-Energy Microgrid Options*": literature review, modeling and the analysis of hydrogen technologies for purposes of emissions reduction in different setups in the microgrid sub-systems.

- [P₄] item In the published paper presented in the international conference "***Mathematical model of flexible multi-energy industrial prosumer under uncertainty***": literature review, two-stage stochastic model of multi-energy industrial prosumer operating on a day-ahead electricity and gas market.
- [P₅] item In the published paper presented in the international conference "***Optimal Cooperative Scheduling of Multi-Energy Microgrids Under Uncertainty***": literature review, possibilities of hydrogen technologies for electricity and heat production as a decarbonisation option.

Chapter 8

Conclusion and Future Work

8.1 Conclusion of the Thesis

The thesis is centred around industrial facilities focusing on their role in the green energy transition. Traditionally end-users were passive participants in the power system. With the change in paradigm, they are incentivised to start participating in different programs and in turn, lower their costs. Production cost in the industrial facility is highly correlated with energy costs meaning that its reduction will make the product more competitive on the global market. Industrial facilities have high flexibility potential and as such have the ability to participate in various programs. Price-responsive demand response can be utilized to schedule the production process of the industrial plant i.e. consumption of various consumption sectors based on the outside price signals from the electricity market. Likewise, they are usually comprised of multiple energy vectors that can satisfy different consumption. The idea of a multi-energy system is that different energy vectors can be used to satisfy certain consumption of industrial facilities (e.g. electricity and gas can be used to produce required heating). Flexibility from both of these concepts can be used to balance the unpredictable production from renewable energy sources and to adjust to uncertain electricity market prices. The results of the stochastic optimisation showcased that industrial facilities are able to participate in an uncertain electricity market. It has enough flexibility so it can mitigate the negative effects of not knowing the exact prices.

In efforts to mitigate the negative effects of climate change, the European Union has placed a lot of policies to decarbonise the power system. Industrial facilities are large energy consumers and as such produce large amounts of emissions either directly or indirectly. Furthermore, they need to buy emission allowances adding additional costs to the facility. Mitigating emissions will provide economic benefits to the industrial facility while addressing the need to stop climate change. Local emissions can be mitigated by switching traditionally used fossil fuels with hydrogen in combination with renewable energy sources. Hydrogen can be produced using excess electricity or consumed to produce electricity and heat. It can also be stored in seasonal storage

for future use. Indirect emissions can be mitigated by lowering the need for electricity import making the industrial facility mostly sustainable. Analysis showcased that this type of industrial facility can almost completely reduce its carbon footprint. On the other hand, economic sensitivity analysis was less in favour of hydrogen-based facilities, while newer technologies had better results. Although their performance was not the best it had much smaller oscillations meaning that is much less dependent on the market prices. This means that hydrogen technologies still have room for improvement and will become even better with better technologies and higher commercialisation.

8.2 Future Work

The future work that the author thinks would help decarbonised industrial facilities to lower their energy costs is to participate in different markets. Futures market contracts can mitigate the risk from the price volatility on the day-ahead market. They are more reflective of the traditional industrial system operation providing better incentives for them to slowly enter the market environment. On the futures market, you enter a short/long position with someone else agreeing to buy/sell a set amount of electricity on a day-ahead market. Day-ahead price is then settled between participants to match the futures price. Intra-day electricity market trading could also be integrated especially if photovoltaic uncertainty is to be considered in the model. Since the uncertainty of photovoltaic production was neglected, industrial plants were always able to follow their consumption curve so it was never had to pay imbalance settlements. With the photovoltaic uncertainty intra-day market would be a good way for industrial plants to fix their consumption curve. The demand response in this thesis was price-based so for future work it would be interesting to have some sort of incentive-based demand response or a combination of both. The implementation of incentive-based demand response would depend on the scheme, whether it was directly from the system operator, from the aggregator or some similar entity. It could also provide ancillary services, probably manual frequency restoration reserve. Providing upwards or downwards capacity and activation of that capacity could also be analysed. I would require thorough analysis to determine viability of each specific industrial facility to participate in ancillary services. All of this market participation is proposed because the decarbonised industrial facility has a lot of flexibility. The longer-term analysis would also be beneficial to better capture the usefulness of hydrogen storage, as it is more suitable for that application. It would also analyse the behaviour in different seasons as some parameters are dependent on it like electricity price and photovoltaic production. A more detailed model for electrolyser and fuel cell would also be beneficial. The analysis includes the emission market to find the breaking point of emission price where the industrial facility is incentivised to severely change its behaviour.

Bibliography

- [1] European Commission, EU energy in figures - Publications Office of the EU, 2020, Available: <https://op.europa.eu/es/publication-detail/-/publication/87b16988-f740-11ea-991b-01aa75ed71a1>
- [2] Ashok, S., Banerjee, R., “Load-management applications for the industrial sector”, *Applied Energy*, Vol. 66, No. 2, 2000, pp. 105-111, Available: <https://www.sciencedirect.com/science/article/pii/S0306261999001257>
- [3] European Parliament, “Fit for 55 - The EU’s plan for a green transition - Consilium”, Available: <https://www.consilium.europa.eu/en/policies/green-deal/fit-for-55-the-eu-plan-for-a-green-transition/>
- [4] Marques Lameirinhas, R. A., Torres, J. P. N., de Melo Cunha, J. P., “A photovoltaic technology review: History, fundamentals and applications”, *Energies*, Vol. 15, No. 5, 2022, Available: <https://www.mdpi.com/1996-1073/15/5/1823>
- [5] Mancò, G., Tesio, U., Guelpa, E., Verda, V., “A review on multi energy systems modelling and optimization”, *Applied Thermal Engineering*, Vol. 236, 2024, p. 121871, Available: <https://www.sciencedirect.com/science/article/pii/S1359431123019002>
- [6] Hussain, I., Mohsin, S., Basit, A., Khan, Z. A., Qasim, U., Javaid, N., “A review on demand response: Pricing, optimization, and appliance scheduling”, *Procedia Computer Science*, Vol. 52, 2015, pp. 843-850, the 6th International Conference on Ambient Systems, Networks and Technologies (ANT-2015), the 5th International Conference on Sustainable Energy Information Technology (SEIT-2015), Available: <https://www.sciencedirect.com/science/article/pii/S1877050915009412>
- [7] El-Shafie, M., Kambara, S., Hayakawa, Y., “Hydrogen Production Technologies Overview”, *Journal of Power and Energy Engineering*, Vol. 07, No. 01, 2019, pp. 107–154.
- [8] Carreiro, A. M., Jorge, H. M., Antunes, C. H., “Energy management systems aggregators: A literature survey”, *Renewable and Sustainable Energy Reviews*, Vol. 73,

- 2017, pp. 1160-1172, Available: <https://www.sciencedirect.com/science/article/pii/S1364032117301776>
- [9] Grzanić, M., Morales, J. M., Pineda, S., Capuder, T., “Electricity cost-sharing in energy communities under dynamic pricing and uncertainty”, *IEEE Access*, Vol. 9, 2021, pp. 30 225-30 241.
- [10] Wenfei, Y., Fei, Z., Mingshen, W., “Optimal operation strategy of virtual power plant with building inverter air conditioner”, in *2023 IEEE International Conference on Power Science and Technology (ICPST)*, 2023, pp. 557-561.
- [11] D’Ettorre, F., Banaei, M., Ebrahimi, R., Pourmousavi, S. A., Blomgren, E., Kowalski, J., Bohdanowicz, Z., Łopaciuk Gonczaryk, B., Biele, C., Madsen, H., “Exploiting demand-side flexibility: State-of-the-art, open issues and social perspective”, *Renewable and Sustainable Energy Reviews*, Vol. 165, 2022, p. 112605, Available: <https://www.sciencedirect.com/science/article/pii/S1364032122005007>
- [12] Kao, H.-A., Jin, W., Siegel, D., Lee, J., “A cyber physical interface for automation systems—methodology and examples”, *Machines*, Vol. 3, No. 2, 2015, pp. 93–106, Available: <https://www.mdpi.com/2075-1702/3/2/93>
- [13] Andrei, M., Thollander, P., Sannö, A., “Knowledge demands for energy management in manufacturing industry - a systematic literature review”, *Renewable and Sustainable Energy Reviews*, Vol. 159, 2022, p. 112168, Available: <https://www.sciencedirect.com/science/article/pii/S1364032122000958>
- [14] Suhr, M., Klein, G., Kourti, I., Rodrigo Gonzalo, M., Giner Santonja, G., Roudier, S., Delgado Sancho, L., *Best Available Techniques (BAT) Reference Document for the Production of Pulp, Paper and Board*, 2015.
- [15] Schorcht, F., Kourti, I., Scalet, B. M., Roudier, S., Sancho, L. D., *Best Available Techniques (BAT) Reference Document for the Production of Cement, Lime and Magnesium Oxide*, 2013.
- [16] Cusano, G., Gonzalo, M. R., Farrell, F., Remus, R., Roudier, S., Sancho, L. D., *Best Available Techniques (BAT) Reference Document for the Non-Ferrous Metals Industries*, 2017.
- [17] Santonja, G. G., Karlis, P., , Brinkmann, T., Roudier, S., *Best Available Techniques (BAT) Reference Document on Food, Drink and Milk Industries*, 2019.
- [18] Brinkmann, T., Giner Santonja, G., Schorcht, F., Roudier, S., Delgado Sancho, L., *Best Available Techniques Reference Document for the Production of Chlor-alkali*, 2014.

- [19] Remus, R., Roudier, S., Aguado-Monsonet, M. A., Delgado Sancho, L., Best available techniques - iron and steel production, 2013, Vol. BREF-IS.
- [20] He, K., Wang, L., “A review of energy use and energy-efficient technologies for the iron and steel industry”, *Renewable and Sustainable Energy Reviews*, Vol. 70, 2017, pp. 1022 - 1039.
- [21] Todd, D., Caufield, M., Helms, B., Starke, M. R., Kirby, B. J., Kueck, J. D., “Providing Reliability Services through Demand Response: A Preliminary Evaluation of the Demand Response Capabilities of Alcoa Inc.”, Tech. Rep., 01/2009 2009.
- [22] Kiliccote, S., Piette, M. A., Koch, E., Hennage, D., “Utilizing automated demand response in commercial buildings as non-spinning reserve product for ancillary services markets”, in 2011 50th IEEE Conference on Decision and Control and European Control Conference, 2011, pp. 4354-4360.
- [23] Arun, C., Aswinraj, R., Bijoy, M. T., Nidheesh, M., Rohikaa Micky, R., “Day ahead demand response using load shifting technique in presence of increased renewable penetration”, in 2022 IEEE 7th International conference for Convergence in Technology (I2CT), 2022, pp. 1-6.
- [24] Gržanić, M., Capuder, T., “Collaboration model between distribution system operator and flexible prosumers based on a unique dynamic price for electricity and flexibility”, *Applied Energy*, Vol. 350, 2023, p. 121735, Available: <https://www.sciencedirect.com/science/article/pii/S0306261923010991>
- [25] Zhang, M., Zhang, Z., Yi, H., Tang, X., “Demand response featured dynamic voltage regulation of active distribution network”, in 2022 IEEE/IAS Industrial and Commercial Power System Asia (ICPS Asia), 2022, pp. 1034-1039.
- [26] Zhao, Y., Peng, D., Zhang, H., Zhao, H., “Optimal scheduling strategy of load aggregator considering user demand response potential”, in 2022 First International Conference on Cyber-Energy Systems and Intelligent Energy (ICCSIE), 2023, pp. 1-5.
- [27] Gils, H. C., “Economic potential for future demand response in germany – modeling approach and case study”, *Applied Energy*, Vol. 162, 2016, pp. 401-415, Available: <https://www.sciencedirect.com/science/article/pii/S0306261915013100>
- [28] Söder, L., Lund, P. D., Koduvere, H., Bolkesjø, T. F., Rossebø, G. H., Rosenlund-Soysal, E., Skytte, K., Katz, J., Blumberga, D., “A review of demand side flexibility potential in northern europe”, *Renewable and Sustainable Energy Reviews*, Vol. 91, 2018, pp. 654-664, Available: <https://www.sciencedirect.com/science/article/pii/S1364032118302053>

- [29] Müller, T., Möst, D., “Demand response potential: Available when needed?”, *Energy Policy*, Vol. 115, 2018, pp. 181-198, Available: <https://www.sciencedirect.com/science/article/pii/S0301421517308509>
- [30] Dranka, G. G., Ferreira, P., “Review and assessment of the different categories of demand response potentials”, *Energy*, Vol. 179, 2019, pp. 280-294, Available: <https://www.sciencedirect.com/science/article/pii/S0360544219308722>
- [31] Gul, S. S., Suchitra, D., “A two level model of energy market considering incentive based demand response”, in *2023 International Conference on Recent Advances in Electrical, Electronics, Ubiquitous Communication, and Computational Intelligence (RAEEUCCI)*, 2023, pp. 1-6.
- [32] Maneebang, K., Methapatara, K., Kudtongngam, J., “A demand side management solution: Fully automated demand response using openadr2.0b coordinating with bems pilot project”, in *2020 International Conference on Smart Grids and Energy Systems (SGES)*, 2020, pp. 30-35.
- [33] Tindemans, S. H., Trovato, V., Strbac, G., “Decentralized control of thermostatic loads for flexible demand response”, *IEEE Transactions on Control Systems Technology*, Vol. 23, No. 5, 2015, pp. 1685-1700.
- [34] Si, J., Bao, G., Liu, H., Sun, M., Zhou, L., Tan, M., Wang, L., Jiang, C., “A bi-level optimization model for independent system operator considering price-based demand response”, in *2022 IEEE/IAS Industrial and Commercial Power System Asia (ICPS Asia)*, 2022, pp. 451-457.
- [35] Duan, Q., “A price-based demand response scheduling model in day-ahead electricity market”, in *2016 IEEE Power and Energy Society General Meeting (PESGM)*, 2016, pp. 1-5.
- [36] Etxegarai, A., Bereziartua, A., Dañobeitia, J. A., Abarrategi, O., Saldaña, G., “Impact of price-based demand response programs for residential customers”, in *2018 19th IEEE Mediterranean Electrotechnical Conference (MELECON)*, 2018, pp. 204-208.
- [37] Meng, F., Ma, Q., Liu, Z., Zeng, X.-J., “Multiple dynamic pricing for demand response with adaptive clustering-based customer segmentation in smart grids”, *Applied Energy*, Vol. 333, 2023, p. 120626, Available: <https://www.sciencedirect.com/science/article/pii/S0306261922018839>
- [38] Tang, R., Wang, S., Li, H., “Game theory based interactive demand side management responding to dynamic pricing in price-based demand response

- of smart grids”, *Applied Energy*, Vol. 250, 2019, pp. 118-130, Available: <https://www.sciencedirect.com/science/article/pii/S0306261919308396>
- [39] Kim, Y.-J., “Optimal price based demand response of hvac systems in multizone office buildings considering thermal preferences of individual occupants buildings”, *IEEE Transactions on Industrial Informatics*, Vol. 14, No. 11, 2018, pp. 5060-5073.
- [40] Althaher, S., Mancarella, P., Mutale, J., “Automated demand response from home energy management system under dynamic pricing and power and comfort constraints”, *IEEE Transactions on Smart Grid*, Vol. 6, No. 4, 2015, pp. 1874-1883.
- [41] Xu, Q., Ding, Y., Yan, Q., Zheng, A., Du, P., “Day-ahead load peak shedding/shifting scheme based on potential load values utilization: Theory and practice of policy-driven demand response in china”, *IEEE Access*, Vol. 5, 2017, pp. 22 892-22 901.
- [42] Wang, S., Bi, S., Zhang, Y.-J. A., “Demand response management for profit maximizing energy loads in real-time electricity market”, *IEEE Transactions on Power Systems*, Vol. 33, No. 6, 2018, pp. 6387-6396.
- [43] Golmohamadi, H., “Demand-side management in industrial sector: A review of heavy industries”, *Renewable and Sustainable Energy Reviews*, Vol. 156, 2022, p. 111963, Available: <https://www.sciencedirect.com/science/article/pii/S1364032121012284>
- [44] Shoreh, M. H., Siano, P., Shafie-khah, M., Loia, V., Catalão, J. P., “A survey of industrial applications of demand response”, *Electric Power Systems Research*, Vol. 141, 2016, pp. 31-49, Available: <https://www.sciencedirect.com/science/article/pii/S0378779616302632>
- [45] Shafie-khah, M., Siano, P., Aghaei, J., Masoum, M. A. S., Li, F., Catalão, J. P. S., “Comprehensive review of the recent advances in industrial and commercial dr”, *IEEE Transactions on Industrial Informatics*, Vol. 15, No. 7, 2019, pp. 3757-3771.
- [46] Chen, Z., Sun, Y., Ai, X., Malik, S. M., Yang, L., “Integrated demand response characteristics of industrial park: A review”, *Journal of Modern Power Systems and Clean Energy*, Vol. 8, No. 1, 2020, pp. 15-26.
- [47] Gholian, A., Mohsenian-Rad, H., Hua, Y., “Optimal Industrial Load Control in Smart Grid”, *IEEE Transactions on Smart Grid*, Vol. 7, No. 5, 2016, pp. 2305-2316.
- [48] Gholian, A., Mohsenian-Rad, H., Yingbo Hua, Joe Qin, “Optimal industrial load control in smart grid: A case study for oil refineries”, in *2013 IEEE Power Energy Society General Meeting*, 2013, pp. 1-5.

- [49] Huang, X., Hong, S. H., Li, Y., “Hour-ahead price based energy management scheme for industrial facilities”, *IEEE Transactions on Industrial Informatics*, Vol. 13, No. 6, 2017, pp. 2886-2898.
- [50] Helin, K., Käki, A., Zakeri, B., Lahdelma, R., Syri, S., “Economic potential of industrial demand side management in pulp and paper industry”, *Energy*, Vol. 141, 2017, pp. 1681-1694, Available: <https://www.sciencedirect.com/science/article/pii/S0360544217319333>
- [51] Wang, X., El-Farra, N. H., Palazoglu, A., “Optimal scheduling of demand responsive industrial production with hybrid renewable energy systems”, *Renewable Energy*, Vol. 100, 2017, pp. 53-64, special Issue: Control and Optimization of Renewable Energy Systems, Available: <https://www.sciencedirect.com/science/article/pii/S096014811630461X>
- [52] Mancarella, P., Chicco, G., “Integrated energy and ancillary services provision in multi-energy systems”, in *2013 IREP Symposium Bulk Power System Dynamics and Control - IX Optimization, Security and Control of the Emerging Power Grid*, 2013, pp. 1-19.
- [53] Vahid-Ghavidel, M., Javadi, M. S., Gough, M., Santos, S. F., Shafie-khah, M., Catalão, J. P., “Demand response programs in multi-energy systems: A review”, *Energies*, Vol. 13, No. 17, 2020, Available: <https://www.mdpi.com/1996-1073/13/17/4332>
- [54] Jiang, Z., Hao, R., Ai, Q., Yu, Z., Xiao, F., “Extended multi-energy demand response scheme for industrial integrated energy system”, *IET Generation, Transmission Distribution*, Vol. 12, No. 13, 2018, pp. 3186-3192.
- [55] Ma, H., Sun, Q., Chen, L., Chen, Q., Zhao, T., He, K., Xu, F., Min, Y., Wang, S., Zhou, G., “Cogeneration transition for energy system decarbonization: From basic to flexible and complementary multi-energy sources”, *Renewable and Sustainable Energy Reviews*, Vol. 187, 2023, p. 113709, Available: <https://www.sciencedirect.com/science/article/pii/S136403212300566X>
- [56] Zhang, C., Xu, Y., Dong, Z. Y., Yang, L. F., “Multitimescale Coordinated Adaptive Robust Operation for Industrial Multienergy Microgrids With Load Allocation”, *IEEE Transactions on Industrial Informatics*, Vol. 16, No. 5, 2020, pp. 3051-3063.
- [57] Holjevac, N., Capuder, T., Zhang, N., Kuzle, I., Kang, C., “Corrective receding horizon scheduling of flexible distributed multi-energy microgrids”, *Applied Energy*, Vol. 207, 2017, pp. 176-194, transformative Innovations for a Sustainable Future – Part II.

- [58] Shafie-Khah, M., Vahid-Ghavidel, M., Di Somma, M., Graditi, G., Siano, P., Catalão, J. P., “Management of renewable-based multi-energy microgrids in the presence of electric vehicles”, *IET Renewable Power Generation*, Vol. 14, No. 3, 2020, pp. 417–426.
- [59] Lesage-Landry, A., Wang, H., Shames, I., Mancarella, P., Taylor, J. A., “Online convex optimization of multi-energy building-to-grid ancillary services”, *IEEE Transactions on Control Systems Technology*, Vol. 28, No. 6, 2020, pp. 2416-2431.
- [60] Ramsebner, J., Haas, R., Auer, H., Ajanovic, A., Gawlik, W., Maier, C., Nemeč-Begluk, S., Nacht, T., Puchegger, M., “From single to multi-energy and hybrid grids: Historic growth and future vision”, *Renewable and Sustainable Energy Reviews*, Vol. 151, 2021, p. 111520, Available: <https://www.sciencedirect.com/science/article/pii/S136403212100798X>
- [61] Hosseini, S. H. R., Allahham, A., Walker, S. L., Taylor, P., “Optimal planning and operation of multi-vector energy networks: A systematic review”, *Renewable and Sustainable Energy Reviews*, Vol. 133, 2020, p. 110216, Available: <https://www.sciencedirect.com/science/article/pii/S1364032120305050>
- [62] “Kyoto Protocol to the United Nations Framework Convention on Climate Change”, 1997, 2303 U.N.T.S. 162.
- [63] “Paris Agreement to the United Nations Framework Convention on Climate Change”, 2015, T.I.A.S. No. 16-1104.
- [64] “The European Green Deal”, Available: https://commission.europa.eu/strategy-and-policy/priorities-2019-2024/european-green-deal_en
- [65] “Clean energy for all Europeans package”, Available: https://energy.ec.europa.eu/topics/energy-strategy/clean-energy-all-europeans-package_en
- [66] “European Climate Law | Climate Action”, Available: https://ec.europa.eu/clima/policies/eu-climate-action/law_en
- [67] Traber, T., Hegner, F. S., Fell, H.-J., “An economically viable 100
- [68] Ulpiani, G., Vettors, N., Shtjefni, D., Kakoulaki, G., Taylor, N., “Let’s hear it from the cities: On the role of renewable energy in reaching climate neutrality in urban europe”, *Renewable and Sustainable Energy Reviews*, Vol. 183, 2023, p. 113444, Available: <https://www.sciencedirect.com/science/article/pii/S1364032123003015>

- [69] LazaroIU, A. C., Panait, C., Popescu, C. L., Popescu, M. O., “Renewable energy sources for decarbonization of smart cities”, in 2023 IEEE International Smart Cities Conference (ISC2), 2023, pp. 1-4.
- [70] Ali, Q., Di Silvestre, M. L., Lombardi, P., Sanseverino, E. R., Zizzo, G., “The role of renewable energy generation in electric vehicles transition and decarbonization of transportation sector”, in 2023 IEEE International Conference on Environment and Electrical Engineering and 2023 IEEE Industrial and Commercial Power Systems Europe (EEEIC / ICPS Europe), 2023, pp. 1-6.
- [71] Chantzis, G., Giama, E., Nižetić, S., Papadopoulos, A. M., “The potential of demand response as a tool for decarbonization in the energy transition”, *Energy and Buildings*, Vol. 296, 2023, p. 113255, Available: <https://www.sciencedirect.com/science/article/pii/S0378778823004851>
- [72] Manisalidis, I., Stavropoulou, E., Stavropoulos, A., Bezirtzoglou, E., “Environmental and health impacts of air pollution: A review”, *Frontiers in Public Health*, Vol. 8, 2020, Available: <https://www.frontiersin.org/articles/10.3389/fpubh.2020.00014>
- [73] Shindell, D., Faluvegi, G., Seltzer, K., Shindell, C., “Quantified, localized health benefits of accelerated carbon dioxide emissions reductions”, *Nature Climate Change*, Vol. 8, No. 4, 2018, pp. 291–295.
- [74] Čović, N., Braeuer, F., McKenna, R., Pandžić, H., “Optimal pv and battery investment of market-participating industry facilities”, *IEEE Transactions on Power Systems*, Vol. 36, No. 4, 2021, pp. 3441-3452.
- [75] Furszyfer Del Rio, D. D., Sovacool, B. K., Griffiths, S., Bazilian, M., Kim, J., Foley, A. M., Rooney, D., “Decarbonizing the pulp and paper industry: A critical and systematic review of sociotechnical developments and policy options”, *Renewable and Sustainable Energy Reviews*, Vol. 167, 2022, p. 112706, Available: <https://www.sciencedirect.com/science/article/pii/S1364032122005950>
- [76] Kamra, J., Mani, A. P., Tripathi, V. M., “Decarbonization trajectory in cement industry”, in 2023 8th International Conference on Smart and Sustainable Technologies (SpliTech), 2023, pp. 1-5.
- [77] Griffiths, S., Sovacool, B. K., Furszyfer Del Rio, D. D., Foley, A. M., Bazilian, M. D., Kim, J., Uratani, J. M., “Decarbonizing the cement and concrete industry: A systematic review of socio-technical systems, technological innovations, and policy options”, *Renewable and Sustainable Energy Reviews*, Vol. 180, 2023, p. 113291, Available: <https://www.sciencedirect.com/science/article/pii/S1364032123001478>

- [78] Furszyfer Del Rio, D. D., Sovacool, B. K., Foley, A. M., Griffiths, S., Bazilian, M., Kim, J., Rooney, D., “Decarbonizing the ceramics industry: A systematic and critical review of policy options, developments and sociotechnical systems”, *Renewable and Sustainable Energy Reviews*, Vol. 157, 2022, p. 112081, Available: <https://www.sciencedirect.com/science/article/pii/S1364032122000119>
- [79] Simoni, M., Wilkes, M. D., Brown, S., Provis, J. L., Kinoshita, H., Hanein, T., “Decarbonising the lime industry: State-of-the-art”, *Renewable and Sustainable Energy Reviews*, Vol. 168, 2022, p. 112765, Available: <https://www.sciencedirect.com/science/article/pii/S1364032122006505>
- [80] Arens, M., Åhman, M., Vogl, V., “Which countries are prepared to green their coal-based steel industry with electricity? - reviewing climate and energy policy as well as the implementation of renewable electricity”, *Renewable and Sustainable Energy Reviews*, Vol. 143, 2021, p. 110938, Available: <https://www.sciencedirect.com/science/article/pii/S1364032121002306>
- [81] Smitkova, M. F., Janicek, F., Martins, F., “Hydrogen economy : Brief sumarization of hydrogen economy”, in *2022 International Conference on Electrical, Computer and Energy Technologies (ICECET)*, 2022, pp. 1-5.
- [82] Lebrouhi, B., Djoupo, J., Lamrani, B., Benabdelaziz, K., Kousksou, T., “Global hydrogen development - a technological and geopolitical overview”, *International Journal of Hydrogen Energy*, Vol. 47, No. 11, 2022, pp. 7016-7048, Available: <https://www.sciencedirect.com/science/article/pii/S0360319921047765>
- [83] Zainal, B. S., Ker, P. J., Mohamed, H., Ong, H. C., Fattah, I., Rahman, S. A., Nghiem, L. D., Mahlia, T. M. I., “Recent advancement and assessment of green hydrogen production technologies”, *Renewable and Sustainable Energy Reviews*, Vol. 189, 2024, p. 113941, Available: <https://www.sciencedirect.com/science/article/pii/S1364032123007992>
- [84] Lagioia, G., Spinelli, M. P., Amicarelli, V., “Blue and green hydrogen energy to meet european union decarbonisation objectives. an overview of perspectives and the current state of affairs”, *International Journal of Hydrogen Energy*, Vol. 48, No. 4, 2023, pp. 1304-1322, Available: <https://www.sciencedirect.com/science/article/pii/S0360319922046675>
- [85] Eicke, L., De Blasio, N., “Green hydrogen value chains in the industrial sector—geopolitical and market implications”, *Energy Research Social Science*,

- Vol. 93, 2022, p. 102847, Available: <https://www.sciencedirect.com/science/article/pii/S2214629622003504>
- [86] Amin, M., Shah, H. H., Fareed, A. G., Khan, W. U., Chung, E., Zia, A., Rahman Farooqi, Z. U., Lee, C., “Hydrogen production through renewable and non-renewable energy processes and their impact on climate change”, *International Journal of Hydrogen Energy*, Vol. 47, No. 77, 2022, pp. 33 112-33 134, Available: <https://www.sciencedirect.com/science/article/pii/S0360319922032244>
- [87] huan ZHANG, Y., chao JIA, Z., ming YUAN, Z., YANG, T., QI, Y., liang ZHAO, D., “Development and application of hydrogen storage”, *Journal of Iron and Steel Research, International*, Vol. 22, No. 9, 2015, pp. 757-770, Available: <https://www.sciencedirect.com/science/article/pii/S1006706X15300698>
- [88] Zhao, D., Li, Z., “Feasibility investigation of hydrogen generation storage”, in 2021 3rd International Academic Exchange Conference on Science and Technology Innovation (IAECST), 2021, pp. 1898-1905.
- [89] Zhu, Y., “From hydrogen production to storage: A process for sustainable development of underground hydrogen storage in caverns”, in 2021 3rd International Academic Exchange Conference on Science and Technology Innovation (IAECST), 2021, pp. 1658-1663.
- [90] chao Fan, X., qing Wang, W., jing Shi, R., jiang Cheng, Z., “Hybrid pluripotent coupling system with wind and photovoltaic-hydrogen energy storage and the coal chemical industry in hami, xinjiang”, *Renewable and Sustainable Energy Reviews*, Vol. 72, 2017, pp. 950-960, Available: <https://www.sciencedirect.com/science/article/pii/S1364032117300989>
- [91] Li, B., “Build 100% renewable energy based power station and microgrid clusters through hydrogen-centric storage systems”, in 2020 4th International Conference on HVDC (HVDC), 2020, pp. 1253-1257.
- [92] Liu, W., Zuo, H., Wang, J., Xue, Q., Ren, B., Yang, F., “The production and application of hydrogen in steel industry”, *International Journal of Hydrogen Energy*, Vol. 46, No. 17, 2021, pp. 10 548-10 569, Available: <https://www.sciencedirect.com/science/article/pii/S0360319920347376>
- [93] Chang, Y., Wan, F., Yao, X., Wang, J., Han, Y., Li, H., “Influence of hydrogen production on the co2 emissions reduction of hydrogen metallurgy transformation in iron and steel industry”, *Energy Reports*, Vol. 9, 2023, pp. 3057-3071, Available: <https://www.sciencedirect.com/science/article/pii/S2352484723000914>

- [94] Ostadi, M., Paso, K. G., Rodriguez-Fabia, S., Øi, L. E., Manenti, F., Hillestad, M., “Process integration of green hydrogen: Decarbonization of chemical industries”, *Energies*, Vol. 13, No. 18, 2020, Available: <https://www.mdpi.com/1996-1073/13/18/4859>
- [95] Samsatli, S., Samsatli, N. J., “The role of renewable hydrogen and inter-seasonal storage in decarbonising heat – comprehensive optimisation of future renewable energy value chains”, *Applied Energy*, Vol. 233-234, 2019, pp. 854-893, Available: <https://www.sciencedirect.com/science/article/pii/S0306261918314715>
- [96] Pan, G., Gu, W., Lu, Y., Qiu, H., Lu, S., Yao, S., “Optimal planning for electricity-hydrogen integrated energy system considering power to hydrogen and heat and seasonal storage”, *IEEE Transactions on Sustainable Energy*, Vol. 11, No. 4, 2020, pp. 2662-2676.
- [97] Miljan, P., Tomsic, Z., Pandzic, H., “Optimal bidding for a large battery-electrolyzer facility in the day-ahead market”, in *2022 IEEE 21st Mediterranean Electrotechnical Conference (MELECON)*. IEEE, 2022, pp. 201–206.
- [98] Danieli, P., Lazzaretto, A., Al-Zaili, J., Sayma, A., Masi, M., Carraro, G., “The potential of the natural gas grid to accommodate hydrogen as an energy vector in transition towards a fully renewable energy system”, *Applied Energy*, Vol. 313, 2022, p. 118843, Available: <https://www.sciencedirect.com/science/article/pii/S0306261922002811>
- [99] Pavić, I., Čović, N., Pandžić, H., “Pv–battery-hydrogen plant: Cutting green hydrogen costs through multi-market positioning”, *Applied Energy*, Vol. 328, 2022, p. 120103, Available: <https://www.sciencedirect.com/science/article/pii/S0306261922013605>
- [100] Gurobi Optimization, LLC, “Gurobi Optimizer Reference Manual”, Available: <https://www.gurobi.com>

Abbreviation

BSS	Battery storage system
DR	Demand response
GHG	Greenhouse gas
MES	Multi-energy system
MILP	Mixed-integer linear programming
PV	Photovoltaic
RES	Renewable energy sources
SO	System operator

Publications

As a part of this thesis, there will be a total of five papers of which three are published in journals and two in international conferences. One journal paper, three international conference papers and two conference papers written in Croatian and presented at a national conference are omitted from this thesis and can be found in the biography section.

Journal Papers

Published

- [P₁] M. Kostelac, I. Pavić, N. Zhang, T. Capuder, "Uncertainty modelling of an industry facility as a multi-energy demand response provider," *Applied Energy*, Volume 307, 2022, 118215, ISSN 0306-2619, doi: 10.1016/j.apenergy.2021.118215
- [P₂] M. Kostelac, I. Pavić, T. Capuder, "Economic and environmental valuation of green hydrogen decarbonisation process for price responsive multi-energy industry prosumer," *Applied Energy*, Volume 347, 2023, 121484, ISSN 0306-2619, doi: 10.1016/j.apenergy.2023.121484
- [P₃] M. Kostelac, L. Herenčić, and T. Capuder, "Planning and Operational Aspects of Individual and Clustered Multi-Energy Microgrid Options," *Energies*, vol. 15, no. 4, p. 1317, Feb. 2022, doi: 10.3390/en15041317

International Conference Papers

Presented and Published

- [P₄] M. Kostelac, I. Pavić and T. Capuder, "Mathematical model of flexible multi-energy industrial prosumer under uncertainty," 2020 International Conference on Smart Energy Systems and Technologies (SEST), Istanbul, Turkey, 2020, pp. 1-6, doi: 10.1109/SEST48500.2020.9203240

- [P₅] M. Kostelac, L. Herenčić and T. Capuder, "Optimal Cooperative Scheduling of Multi-Energy Microgrids Under Uncertainty," 2021 International Conference on Smart Energy Systems and Technologies (SEST), Vaasa, Finland, 2021, pp. 1-6, doi: 10.1109/SEST50973.2021.9543123

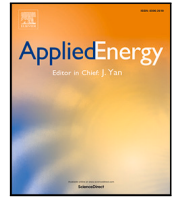

Uncertainty modelling of an industry facility as a multi-energy demand response provider

Matija Kostelac^{a,*}, Ivan Pavić^a, Ning Zhang^b, Tomislav Capuder^a

^a Faculty of Electrical Engineering and Computing, University of Zagreb, Zagreb, Croatia

^b Department of Electrical Engineering, Tsinghua University, Beijing, China

ARTICLE INFO

Keywords:

Demand response
Energy flow modelling
Flexibility
Industry facility
Multi-energy system
Robust optimisation

ABSTRACT

While the latest European energy regulations emphasise the active power system participation of the household level end-users, the large industrial facilities are still not fully exploiting all the market opportunities to decrease their costs and become more competitive. Significant cost reduction can be achieved by offering flexibility services in the electricity market. This is especially valid in the case when the industrial consumers are multi-energy hubs where shifting and optimising usage of input energy vectors creates additional opportunities. Research gaps were identified and a price responsive demand response model for a multi-energy industry facility under uncertainty was developed. The uncertainty aspects are modelled both by the robust optimisation and by the two-stage stochastic optimisation. Additionally, we develop a linear energy flow-based model of an industrial steam system which better encompasses losses and makes the model more realistic. The model is validated on a real-world case of a multi-energy industry facility and the results indicate that cost savings of up to 18 % can be achieved compared to the passive and deterministic, mass flow-based business-as-usual behaviour.

1. Introduction

Industrial plants are complex systems comprised of multiple interconnected processes and devices. They usually incorporate multiple energy vectors and local electricity and heat production. Since they are energy-intensive, energy costs take a major part in their overall production expenditures. Thus, proper energy consumption management can lead to an increase in profit and to a more competitive product. Industry in EU accounts for around 25% of total electricity consumption [1] and large industrial consumers can have rated power in the order of tens of megawatts for both electricity and heat [2].

In recent years the power system experienced major changes, from high penetration of renewable sources to liberalisation of electricity markets. Nowadays, there are multiple ways of buying electricity from intermediate power suppliers to directly competing on the power exchange. The most relevant organised energy market is the day-ahead market (DAM) where producers and consumers place bids and offer ahead of delivery time. After the gate closure, the bids and offers are processed and the volumes and prices are publicly announced. The participants must obey those schedules in real-time. In EU markets, all deviations which occur in real-time are subject to imbalance prices [3,4], reducing the profit of the participant [5,6]. The electricity prices on DAM are unknown before the market-clearing, meaning they

need to be considered as an uncertain parameter. There are different techniques for modelling and dealing with uncertainty. For a more detailed overview of electricity markets, we refer to [7] and for a concrete market structure explanation of our reference market used in this paper we refer to [8]. Further on, for market participation overview of renewable and distributed energy resources, we refer to [9], while ENTSO-E market report [10] provides a good insight in the development of electricity markets and coupling between balancing and energy markets across Europe. Large industrial prosumers with the capacity of several tens of MWs can settle their electricity needs directly on the DAM. When planning their operation in response to the electricity market price changes, they become exposed to multiple uncertainties which, if not dealt adequately, can reflect negatively on the end-product costs.

Demand response (DR) is defined as a change in the electricity consumption pattern of the end-user in response to some signal (compared to the no-response pattern) [11,12]. Benefits for the end-users are usually in form of incentive payments or discounts. System operator benefits from DR by having an additional source for energy balancing [13]. Overall DR has been proven as a valuable asset in decarbonisation of energy system as discussed by authors in [14], where

* Corresponding author.

E-mail address: matija.kostelac@fer.hr (M. Kostelac).

Nomenclature

$\alpha_{p, t}$	Number of time process p has started up to time t
$\beta_{p, t}$	Electrical load of process p at the time t
χ	Gas bid on day ahead market
ΔC_t^{el}	Electricity price variance in hour t
$\delta_{p, t}$	Heating load of process p at the time t
$\epsilon_{b, t}$	Indicate whether the boiler b operate at time t
η_e^E	Efficiency of electric motor e
η_g^G	Efficiency of gas motor g
η_n^N	Efficiency of turbine n
η_v^V	Efficiency of valve v
η_n^{gen}	Efficiency of generator connected to turbine n
Γ	Uncertainty budget
$\gamma_{p, t}$	Motor load of process p at the time t
$l_{p, t}$	Indicate whether the process p is interrupted at the time t
$\zeta_{b, t}$	Indicate whether the boiler b is in warm state at time t
λ	Dual variables in robust optimisation
$\mu_{p, t}$	Amount of materials inside process p at the time t
$\nu_{b, t}$	Indicate whether the boiler b started from cold state at time t
$\omega_{p, t}$	Number of time process p has ended up to time t
$\bar{\mu}_{p, t}$	Material that entered process p at the time t
$\phi_{v, t}$	Indicate whether the valve v operate at time t
λ	Dual variables in robust optimisation
$\mu_{p, t}$	Amount of materials inside process p at the time t
$\kappa_{b, t}$	Indicate whether the boiler b started from warm state at time t
$\alpha_{p, t}$	Number of time process p has started up to time t
$\bar{\mu}_{p, t}$	Material that entered process p at the time t
$\phi_{v, t}$	Indicate whether the valve v operate at time t
π_t	Electricity bid on day ahead market at time t
Ψ, ψ	Set and index for each stochastic scenario
$\rho_{n, t}$	Indicate whether the turbine n operate at time t
$\sigma_{i, t}$	Storage of initial material i at the time t
τ_r, t	Storage of intermediate material r at the time t
$\theta_{b, t}$	Indicate whether the boiler b is in cold state at time t
$\underline{\mu}_{p, t}$	Material that left process p at the time t
$v_{f, t}$	Storage of final product f at the time t

ξ_ψ	Probability of scenario ψ
$\zeta_{b, t}$	Indicate whether the boiler b is in warm state at time t
$a_{e, t}$	Output power of electric motor e at the time t
B, b	Set and index for each boiler
B_b^{cdt}	Time needed for boiler b to cool down
B_b^{cs}	Additional gas needed to star boiler b from cold state
B_b^k, B_b^l	Slope and y-intercept for gas-to-heat conversion of boiler b
B_b^{ws}	Additional gas needed to star boiler b from warm state
C_t^{el}	Price of electricity in hour t
C^{gas}	Price of gas
$d_{g, t}$	Output power of gas motor g at the time t
E, e	Set and index for each electric motor
F, f	Set and index for each final product
G, g	Set and index for each gas motor
$h_{b, t}$	Gas input of boiler b at the time t
HtP_n	Heat to power ratio of turbine n
I, i	Set and index for each intermediate material
$I_{e,p}^{P-E}$	Process-electric motor coefficient matrix
$I_{g,p}^{P-G}$	Process-gas motor coefficient matrix
$I_{f,p}^{PI-F}$	Process input-final material coefficient matrix
$I_{r,p}^{PI-I}$	Process input-intermediate material coefficient matrix
$I_{i,p}^{PI-R}$	Process input-raw material coefficient matrix
$I_{f,p}^{PO-F}$	Process output-final material coefficient matrix
$I_{r,p}^{PO-I}$	Process output-intermediate material coefficient matrix
$I_{i,p}^{PO-R}$	Process output-raw material coefficient matrix
$I_{b,s}^{S-B}$	Pressure level-boiler coefficient matrix
$I_{n,s}^{S-N}$	Pressure level-turbine coefficient matrix
$I_{p,s}^{S-P}$	Pressure level-process coefficient matrix
$I_{v,s}^{S-V}$	Pressure level-valve coefficient matrix
$k_{n, t}$	Input power of turbine n at the time t
N, n	Set and index for each turbine
$o_{b, t}$	Output power of boiler b at the time t
P, p	Set and index for each process
p_p^l, \max	Maximum input of a process
p_p^l, \min	Minimum input of a process
p_p^l	Length of process i
p_p^{Dl}	Length of interruption of process i
$p_p^{El,k}, p_p^{El,l}$	Slope and y-intercept for electric load of process p
R, r	Set and index for each raw material
S, s	Set and index for each steam pressure level
$S_f^{F,max}$	Maximum storage of final product f
$S_f^{F,min}$	Minimum storage of final product f

they analyse role and value of DR in large-scale 100% renewable power system. Industrial plants are suitable for DR provision due to their high energy needs leading to potentially significant DR capacities. Ideally,

the industry would provide DR services without incurring losses in production [15]. This paper will focus on the price-responsive DR, which adjusts its consumption based on predicted market prices. Multi-energy

$S_f^{f,goal}$	Amount of final product f needed
$S_i^{I,max}$	Maximum storage of intermediate material i
$S_i^{I,min}$	Minimum storage of intermediate material i
$S_i^{I,0}$	Initial storage state of intermediate material i
$S_r^{R,max}$	Maximum storage of raw material r
$S_r^{R,min}$	Minimum storage of raw material r
T, t	Set and index for each time step
$u_{g, t}$	Indicate whether the gas motor g operate at time t
V, v	Set and index for each valve
$x_{p, t}$	Indicate whether the process p operate at time t
$y_{e, t}$	Indicate whether the electric motor e operate at time t

flexibility can be used to lessen production losses while providing DR services by switching between different energy vectors [16].

In this paper, we developed models for the operation of the industrial facility with integrated price-responsive demand response and cast them both as two-stage stochastic and robust mixed-integer linear programs (MILP) to deal with uncertainty.

1.1. Relevant literature

In the relevant literature review, we identified several research gaps. First, to the authors' knowledge, all papers dealing with linear models of steam/heat industry facilities rely on the mass flow modelling approach. These models are easy to implement, however they neglect the process losses and result in unrealistic operational states which lead to penalties. Refs. [17–20] fall into this category as they present different MILP optimisation approaches to modelling industrial steam and the power system interaction. In [17] only the steam part of the system is considered. The authors use four different optimisation types (objective functions) such as fuel minimisation and electricity production maximisation. Ref. [18] proposes a simple optimisation model of a steam plant only considering one point in time. The results are compared with a real operation state of a certain petrochemical plant. In [19] optimisation of the CHP plant is presented. It is based on the maximisation of the profit from selling electricity and heat. A CHP model is presented in [20] where the mass flow model is used in optimisation, however with constant enthalpy. The second class of modelling approaches belong to the mixed-integer nonlinear programming (MINLP) class which are more accurate in terms of capturing the complexity in models, but also yield higher computational time and/or do not guarantee global optimum.

In [21,22] the emphasis is on detailed modelling of multiple extraction steam turbines. However, there is no interaction with the market or analysis of savings due to flexibility provision. A way of dealing with bilinear turbine constraints by fixing certain variables as parameters is shown in [23]. Parameters are fixed using an iterative approach where after every optimisation, simulation is used for parameter adjusting until model convergence is achieved. Unlike the above work, this paper proposes a detailed linear model of gas boilers and heat recovery steam generators, modelling them with start-up costs, minimum uptime and downtime, different efficiency regions and different fuels. The model keeps the simplicity and low computational time characteristic for MILP, while still accounting for losses. Details are elaborated in Section 2.2.

The second gap identified is the absence of adequate modelling of the industry facilities responding to market signals. In literature where this is analysed, the uncertainties in the process or market participation are completely neglected. To the authors' knowledge, only a few papers are dealing with this topic like [20,24,25]. The authors of [20] use a bit simpler process formulation for load scheduling from the work in [24] and ours. The goal of their model is to achieve more efficient optimisation of CHP operation through the process scheduling. The paper does not use any form of dynamic electricity pricing, but a single price of electricity for the entire optimisation horizon. The second paper [24] presents the formulation for load control of batch processes. Their optimisation goal is profit maximisation from the production of the final product and they only consider electricity as an expenditure. Their electricity pricing is deterministic and based on different smart pricing schemes like time-of-use and peak pricing. Paper [26] is prior work from the same authors on this subject and is based on a case study of a real industrial plant. Third mentioned paper [25] uses multi-objective optimisation method to solve industrial load scheduling problem. The optimisation is deterministic, considering time of use electricity price data. The objective is to reduce cost of electricity while maintaining user satisfaction. Furthermore, there are other paper showcasing benefits of industrial DR, not solely based on load scheduling. For example, paper [27] is using adaptive robust optimisation for scheduling of multi-energy microgrid considering different time scales. The uncertainty in their comes from stochastic wind and solar production, while load shifting and multi-energy flexibility is used to mitigate this uncertainty. Additionally, in [28] neural network model of industrial load is trained to estimate the real power consumption of the load. The forecast is then used to determine the optimal load voltage profile to minimise energy consumption.

The literature review does not recognise the opportunities offered by optimal process scheduling and multi-energy flexibility within an industrial facility operating as a market entity nor does it discuss modelling for flexible rescheduling of these inner processes.

1.2. Contribution and organisation

The state-of-the art literature only superficially addresses the challenges of industrial facility demand response provision and lacks correct and complete mathematical representations. Furthermore, electricity price uncertainty is not adequately covered in industrial optimisation models. Therefore, we propose an innovative modelling approach which encompasses all those shortcomings where main scientific contributions of this paper are:

- Linear energy-flow model for an industrial steam system which considers losses and yields a far more accurate energy schedule compared to the state-of-the-art mass-flow based model described in the literature.
- Model of a novel price-responsive demand response based on daily production scheduling of multi-energy industrial prosumer, which results in additional energy savings for the industry prosumer.
- Formulation of a new two-stage stochastic and robust market-driven optimisation model of the multi-energy industrial prosumer.

The remaining of the paper is organised as follows. Section 2 provides concept description of the proposed models. Section 3 provides mathematical framework of the reference model with market participation along with the robust and two-stage stochastic formulations. Section 4 presents the case study and parameters used in optimisation. Section 5 elaborates on the results and benefits of optimisation for both models and compares them to the business as usual approach. Chapter 6 concludes the paper.

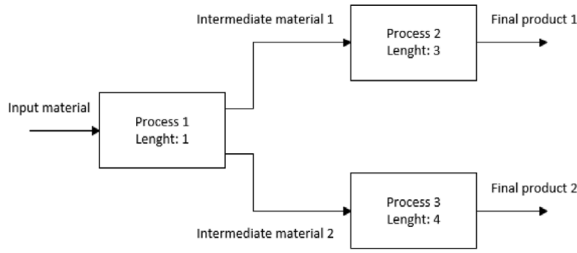

Fig. 1. Generic industrial process scheme.

2. Model description

2.1. Concept of the industrial system

Industrial plants usually consist of multi-stage operations where the material goes through several transformations/refinements to reach the final product, e.g. cement production as in [2]. Generic industrial facility model is shown in Fig. 1. It is based on the scheduling of batch and continuous processes. Batch units take input material at the beginning of each batch cycle and give the output product at the end of the cycle, while in the continuous process the inputs and the outputs are fed and produced continuously. In terms of mathematical implementation in optimisation model presented in Section 3, continuous and batch processes will use same the variables and constraints, but the process duration of continuous process will always be 1 h (one optimisation step). The first number on Fig. 1, in the square, is the ordinal number of the process and the second number indicates the length of the process in hours. Thus, process 1 is a continuous process and processes 2 and 3 are batch processes. These units are chained together to simulate the operation of an industrial plant. Two process chains can be identified in Fig. 1: 1–2 and 1–3. Process units may have different types of loads that are satisfied using different devices (e.g. heat load is satisfied with gas boilers).

We consider that the analysed industrial prosumer buys electricity and gas from their respective day-ahead markets. Prices on the day-ahead market are unknown beforehand, so the model will have to deal with this uncertainty. Since they are subject to predictions, they are prone to errors. The gas price is assumed to be known since its variability is negligible. Three different models are created. The first model represents business as usual approach (BaU) and does not employ demand response or multi-energy flexibility. Its primary purpose is the comparison with other models and is it made as a robust model for a better comparison with the robust model. The remaining two models deal with uncertainty in different ways. These models will be explained in more detail in chapters 3 and 4. Models are named as follows:

- Robust model without demand response and multi-energy flexibility (BaU)
- Two-stage stochastic model with demand response (SO)
- Robust model with demand response (RO)

2.2. Energy flow

This paper proposes a linear optimisation approach for steam flow inside an industrial-grade steam system based on a heat energy flow. Linear optimisation models may be limiting in terms of modelling as opposed to nonlinear models. However, they are significantly faster and can reach the global optimum. Usually, when using linear models, the state-of-the-art literature in the relevant area considers simplified mass-flow modelling for steam systems modelling [17–20]. This simplification/approximation has certain pitfalls which can easily be explained on the example of a simple steam system. Steam is usually produced on higher or different pressure levels than needed, so it needs

to be reduced to appropriate levels via relief valves or turbines. In mass-flow models, input and output flow from a turbine is equal and has either a linear relation for output electricity or an assumption is made on the constant enthalpy of input and output steam. The same modelling principle is used for valves but without the electricity output. Since the above approach does not adequately incorporate process losses, this paper proposed a new energy-flow based modelling approach that resolves the above-mentioned issue. The Eq. (2.1) represents the law of conservation of energy for a turbine, which says that input energy is equal to the sum of output heating energy (out), mechanical energy (mh) and losses inside the turbine (loss). Mechanical energy is defined with heat to power ratio (HtP) and losses with the efficiency coefficient as shown in (2.2) and (2.3) respectively. By combining Eqs. (2.1)–(2.3) a heating input–output relation is created as shown in (2.4). Eq. (2.5) calculates electricity output from a generator which is the mechanical output multiplied by the generator efficiency. The valve is a much simpler device so its input–output energy is calculated using efficiency as shown in (2.6). Operating input–output variables of a boiler is shown in (2.7). However, a more detailed model of a boiler will be shown in Section 3.1. Please note that while the efficiencies are going to be kept constant in our model, they can be modelled as dependent on operating point with piecewise-linear approximation or some similar method [29,30].

$$k^{in} = k^{out} + k^{mh} + k^{loss} \quad (2.1)$$

$$k^{mh} = k^{out} \cdot HtP \quad (2.2)$$

$$k^{loss} = k^{in} \cdot \eta^N \quad (2.3)$$

$$k^{out} = k^{in} \cdot \frac{1 - \eta^N}{1 + HtP} \quad (2.4)$$

$$k^{el} = k^{mh} \cdot \eta^{gen} \quad (2.5)$$

$$I^{out} = I^{in} \cdot \eta^v \quad (2.6)$$

$$h = o \cdot B^k + B^l \quad (2.7)$$

The difference between these two approaches can be seen in Figs. 2 and 3. Fig. 2 shows the energy and the mass flow through a turbine and Fig. 3 through a valve. Numbers in these figures are normalised so they are easier to compare. We assume that the demand is fixed and the same in both modelling cases and we normalise it to 0.5 for both steam pressure levels. The first thing that can be noticed in these two figures is that there is a difference in gas consumption when using different devices in energy flow modelling (1.18 in Fig. 2a when using turbine and 1.17 in Fig. 3a when using a valve). On the other hand, even though different devices are utilised in the process, the gas consumption is the same in both cases of mass flow (1.12 both in Fig. 2b and Fig. 3b). Secondly, it can be seen that electricity production affects both turbine input and gas consumption in energy flow modelling (Fig. 2a). Last and probably the most important thing to notice is the difference in gas consumption of boilers. In the case of mass flow, it is lower, because losses are neglected and electricity production is not taken into account. This simple visualisation of modelling differences clearly shows that mass flow models cannot accurately reflect the real operational conditions of an industrial facility.

3. Mathematical framework

The described problem is solved as a mixed-integer linear program (MILP) modelling the market and demand uncertainties. This section provides a mathematical framework for the concepts explained in Appendix. Two models are created to compare their effectiveness in dealing with uncertainty. The first one is a two-stage stochastic optimisation (SO) which uses uncertainty scenarios created from uncertain data whose probability distribution is known. The second model is robust optimisation (RO) which deals with uncertainty through robust sets whose probability distribution does not have to be known. For a more detailed framework on stochastic modelling the reader is directed

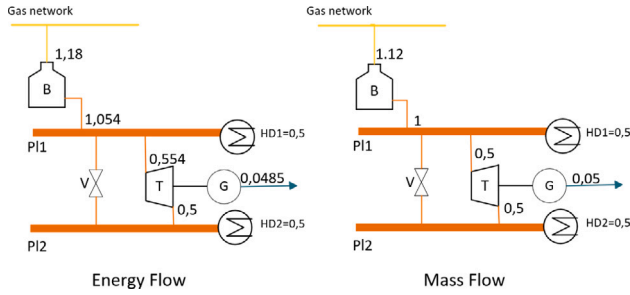

Fig. 2. Energy and mass flow through turbine.

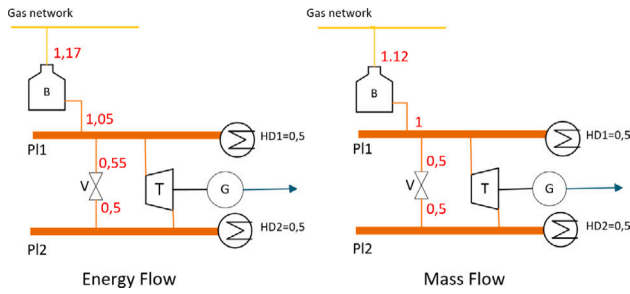

Fig. 3. Energy and mass flow through valve.

to [31,32]. Ref. [33] provides concepts and examples on stochastic modelling in various electricity markets (DAM, intraday, futures, etc.) and from a standpoint of different market participants. For a general framework concerning robust optimisation, we refer to [34,35] and for a more practical implementation of robust optimisation focusing on computational attractiveness and modelling power to [36]. The reference model is created as a base for all three models, RO, SO and BaU since most of the variables and constraints are shared between them. The specific formulation of RO, SO and BaU, will be presented and explained in Sections 3.2–3.4.

3.1. Reference model

To the best of the authors knowledge, only two papers from the field of modelling industrial plants recognise the benefits of scheduling industrial processes interlinked with energy devices inside of an industrial plant [20,24]. In all other cases, the demand is presented as a single cumulative value for the entire facility. This modelling approach creates additional flexibility options by sifting processes in time, as long as the quality and quantity of the final product are maintained. In the proposed model one optimisation step is equal to one hour and the optimisation horizon is set to 24 h (one day). A detailed demand model of an industrial plant with process scheduling is described further in this section.

Variables α and ω denote how many batch cycles have started/finished during the optimisation. For example, if the duration of one batch cycle is 3 h and the process is ongoing for 4 h, this means that the process has finished one batch cycle, $\omega = 1$, and is 1 h into the second cycle, $\alpha = 2$. The constraints (3.1) and (3.2) are mathematical formulation that is keeping track of the amount of process starts/ends. Materials are taken by the process only at the beginning of the batch cycle (i.e. $\alpha_{p,t} - \alpha_{p,t-1} = 1$) and output products are produced at the end of the batch cycle (i.e. $\omega_{p,t} - \omega_{p,t-1} = 1$). In the optimisation model, the process outputs are modelled as if they are finalised at the beginning of step $t + 1$, although in reality they are finalised at the end of step t . Eqs. (3.3) and (3.4) limit minimum and maximum amount of inputs to process. Variable $\mu_{p,t}$ is used for tracking the amount of materials that was inputted or outputted in each batch process as shown

in (3.5). This variable is important, since some parts of the model can be dependent on the volume of materials that process is working on. To maintain the mass conservation law, total process output must be equal to process input, which is enforced by (3.6) and (3.7). These two constraints are if-then constraints, called indicator constraints, and are explained in Appendix. In short, if the term on the left side is true then the constraint on the right side must be enforced, if the term is false no additional constraint is enforced.

$$(\alpha_{p,t} - 1) \cdot P_p^I + 1 \leq \sum_{k=1}^I x_{p,k} \leq \alpha_{p,t} \cdot P_p^I \quad (3.1)$$

$$\omega_{p,t} \cdot P_p^I \leq \sum_{k=1}^I x_{p,k} \leq (\omega_{p,t} + 1) \cdot P_p^I - 1 \quad (3.2)$$

$$\bar{\mu}_{p,t} \leq P_p^{I, \max} \cdot (\alpha_{p,t} - \alpha_{p,t-1}) \quad (3.3)$$

$$\bar{\mu}_{p,t} \geq P_p^{I, \min} \cdot (\alpha_{p,t} - \alpha_{p,t-1}) \quad (3.4)$$

$$\mu_{p,t} = \mu_{p,t-1} + \bar{\mu}_{p,t} - \underline{\mu}_{p,t} \quad (3.5)$$

$$\omega_{p,t} - \omega_{p,t-1} = 1 \rightarrow \underline{\mu}_{p,t+1} = \mu_{p,t} \quad (3.6)$$

$$\omega_{p,t} - \omega_{p,t-1} = 0 \rightarrow \underline{\mu}_{p,t+1} = 0 \quad (3.7)$$

During the production some processes can be interrupted for a certain amount of time, i.e. they can shift their production without losing progress or impacting the end product. When the process has started and before it finishes it must be either in running mode ($x_{p,t} = 1$) or in interrupted mode ($i_{p,t} = 1$). To convey this behaviour next three equations are introduced. Eq. (3.8) ensures that the process can only be interrupted when it is running, (3.9) models that the process is either running or is interrupted and (3.10) ensures that if the process is running at least one of the binary variables, $i_{p,t}$ or $x_{p,t}$, must be equal to 1. Eq. (3.11) defines the maximum length of interruption at the start of each process batch cycle.

$$i_{p,t} \leq \alpha_{p,t} - \omega_{p,t} \quad (3.8)$$

$$i_{p,t} + x_{p,t} \leq 1 \quad (3.9)$$

$$i_{p,t} + x_{p,t} \geq \alpha_{p,t} - \omega_{p,t} \quad (3.10)$$

$$\alpha_{p,t} - \alpha_{p,t-1} = 1 \rightarrow \sum_{k=t}^{t+P_p^I + P_p^{DI}} i_{p,k} \leq P_p^{DI} \quad (3.11)$$

The load of the process depends on the current state that it is in: operational or interrupted. When in the operation state, the process is producing/refining the product and its load is linearly dependent on volume of material the process is working on. The interrupted state considers that the process has started but was halted in order to shift demand. In this state, the process can have a fixed predefined load which is needed so the progress of the process is not lost. For example in aluminium production, the temperature must not fall below a certain threshold, so heating energy is needed [37]. Each process can have 3 types of load: electric, heat and mechanical (motor). Eqs. (3.12), (3.14) and (3.15) calculate the electrical, mechanical and heating load when process is in operation, respectively. If the process is interrupted fixed load is calculated with (3.13) and (3.16).

$$x_{p,t} = 1 \rightarrow \beta_{p,t} = \mu_{p,t} \cdot P_p^{El,k} + P_p^{El,l} \quad (3.12)$$

$$i_{p,t} = 1 \rightarrow \beta_{p,t} = P_p^{El,D} \quad (3.13)$$

$$x_{p,t} = 1 \rightarrow \gamma_{p,t} = \mu_{s,p,t} \cdot P_p^{Ml,k} + P_p^{Ml,k} \quad (3.14)$$

$$x_{p,t} = 1 \rightarrow \delta_{p,t} = \mu_{p,t} \cdot P_p^{Hl,k} + P_p^{Hl,k} \quad (3.15)$$

$$i_{p,t} = 1 \rightarrow \delta_{p,t} = P_p^{Hl,D} \quad (3.16)$$

The proposed model considers two types of materials, raw and intermediate materials. Raw materials are supplied to the process as input and intermediate materials are produced during plant operation and are needed for other subsequent processes. Final products are

overall outputs from our plant. Both types of material and final product have initial storage value (set in the hour 0) and their minimum and maximum storage is defined with (3.17), (3.19) and (3.21). If an intermediate material cannot be stored, minimum and maximum values are set to 0. This means that the material must be used immediately after it is produced. Eqs. (3.18), (3.20) and (3.22) connect storage (raw materials, intermediate materials and final products respectively) with inputs and outputs from the processes. Coefficients in these I matrices correspond to ratio of materials; for example if process 1 takes raw material 1 and 2 in ratio 60% and 40% respectively, coefficients will be $I_{1,1}^{PI-R} = 0.6$ and $I_{2,1}^{PI-R} = 0.4$. Coefficients for other materials and products, not used by this process, will be zero. Intermediate storage and final storage are defined for every $t \in (T + 1)$ so that the process that finished in the last hour can output their products in hour $T + 1$. All intermediate materials supplied in hour zero must be at least equal to intermediate material in the hour $T + 1$ as shown in (3.23). Similarly, the amount of final product that needs to be produced by the end of optimisation horizon ($T + 1$) is defined by (3.24).

$$S_i^{R,min} \leq \sigma_{r,t} \leq S_i^{R,max} \quad (3.17)$$

$$\sigma_{r,t} = \sigma_{r,t-1} - \sum_{k=1}^P I_{r,k}^{PI-R} \cdot \bar{\mu}_{k,t} + \sum_{k=1}^P I_{r,k}^{PO-R} \cdot \underline{\mu}_{k,t} \quad (3.18)$$

$$S_r^{I,min} \leq \tau_{i,t} \leq S_r^{I,max} \quad (3.19)$$

$$\tau_{i,t} = \tau_{i,t-1} - \sum_{k=1}^P I_{i,k}^{PI-I} \cdot \bar{\mu}_{k,t} + \sum_{k=1}^P I_{i,k}^{PO-I} \cdot \underline{\mu}_{k,t} \quad (3.20)$$

$$S_f^{F,min} \leq v_{f,t} \leq S_f^{F,max} \quad (3.21)$$

$$v_{f,t} = v_{f,t-1} - \sum_{k=1}^P I_{f,k}^{PI-F} \cdot \bar{\mu}_{k,t} + \sum_{k=1}^P I_{f,k}^{PO-F} \cdot \underline{\mu}_{k,t} \quad (3.22)$$

$$\tau_{f,T+1} \geq S^{1,0} \quad (3.23)$$

$$v_{f,T+1} \geq S^{F,min} \quad (3.24)$$

A process can have different modes of operation. For example process with length of “n” and input “m” can also work in half mode (length $\frac{n}{2}$, input $\frac{m}{2}$). To model this behaviour we introduce a term subprocess. It is physically the same as its corresponding process but with different parameters. In terms of mathematical implementation subprocesses are modelled exactly the same as processes with Eqs. (3.1)–(3.24). Both the process and its subprocess cannot work at the same time, which is enforced with (3.25).

$$x_{p,t} + x_{p,t}^{Subprocess} \leq 1 \quad (3.25)$$

The industrial facility can satisfy the process loads by using various devices. Electricity load can be satisfied by purchasing it from the electricity day-ahead market or by generating it from generators connected to the steam turbines. The mechanical load can be satisfied either by electric motors or gas motors. The steam system consist of different pressure levels. Steam production units and loads are connected to specific pressure level. Turbines and valves connect different pressure levels and reduce the pressure of steam. All devices in the model use at least four general constraints. First, two of those constraints, limit the minimum and maximum output power (in case of electric motors, gas motors and boilers) or input power (in case of turbines and valves), shown in (3.26). The other two constraints are for minimum and maximum ramp rate, shown in (3.27) and (3.28). Variables and parameters for electric motors are used as an example for these general constraints.

$$E_{e,t}^{min} \cdot y_{e,t} \leq a_{e,t} \leq E_{e,t}^{max} \cdot y_{e,t} \quad (3.26)$$

$$a_{e,t} - a_{e,t-1} \leq E_e^{rampdown} \quad (3.27)$$

$$a_{e,t-1} - a_{e,t} \leq E_e^{rampup} \quad (3.28)$$

Except for the Eqs. (3.26)–(3.28), boilers need an additional set of constraints to work properly. They have three different states, *on* state

when it is in operation and two *off* states entitled *warm* and *cold* and defined by (3.29). When the boiler shuts down it transitions from *on* state to *warm* state constrained by (3.30). When the cooldown time has passed and if the boiler did not start again, it must transition to *cold* state (3.31). Eqs. (3.32) and (3.33) ensure that impossible transitions between states cannot happen, e.g. from *cold* to *warm* state. When the boiler is starting it requires additional energy input depending on which state it is in, *worm* or *cold*. Constraints (3.34) and (3.35), set binary variables $v_{b,t}$ and $\kappa_{b,t}$ to 1 if the boiler has started from *cold* or *warm* state, respectively. With (3.36)–(3.38), starting binary variable are hard constrained so they can only be 1 in case of (3.34) and (3.35). Total gas used by the boiler in each hour is calculated using (3.39).

$$e_{b,t} + \zeta_{b,t} + \theta_{b,t} = 1 \quad (3.29)$$

$$\zeta_{b,t} \geq e_{b,t-1} - e_{b,t} + \zeta_{b,t-1} - \theta_{b,t} \quad (3.30)$$

$$\theta_{b,t} \geq \sum_{k=t-B_b^{cdt}}^t (\zeta_{b,k} + \theta_{b,k}) - B_b^{cdt} - e_{b,t} + 1 \quad (3.31)$$

$$\zeta_{b,t} + \theta_{b,t-1} \leq 1 \quad (3.32)$$

$$\theta_{b,t} + e_{b,t-1} \leq 1 \quad (3.33)$$

$$\theta_{b,t-1} - \theta_{b,t} \leq v_{b,t} \quad (3.34)$$

$$\zeta_{b,t-1} - \zeta_{b,t} - \theta_{b,t} \leq \kappa_{b,t} \quad (3.35)$$

$$e_{b,t-1} + \kappa_{b,t} + v_{b,t} \leq 1 \quad (3.36)$$

$$\theta_{b,t} + \zeta_{b,t} + \kappa_{b,t} \leq 1 \quad (3.37)$$

$$\theta_{b,t} + \zeta_{b,t} + v_{b,t} \leq 1 \quad (3.38)$$

$$h_{b,t} = o_{b,t} \cdot B_b^k + e_{b,t} \cdot B_b^l + v_{b,t} \cdot B_b^{cs} + \kappa_{b,t} \cdot B_b^{BWS} \quad (3.39)$$

Electric and gas motors are connected to their belonging process via matrices $I_{i,p}^{P-E}$ and $I_{g,p}^{P-G}$ where 1 means that the motor is connected to that specific process as shown in (3.40). Eq. (3.41) allows that only one motor connected to the process, either gas or electric, can work at the same time. The heat energy balance equation for each pressure level is defined by (3.42). Matrices $I_{p,s}^{S-P}$ and $I_{b,s}^{S-B}$ are equal to 1 if the load or the process is connected to that pressure level. For turbines and valves, $I_{n,s}^{S-N}$ and $I_{v,s}^{S-V}$ are -1 if they extract steam from that pressure level and 1 if they output steam to that pressure level. Please note that when the steam is outputted Eqs. (2.4) and (2.6) are used.

$$\gamma_{p,t} = \sum_{k=1}^E I_{k,p}^{P-E} \cdot a_{k,t} + \sum_{k=1}^G I_{k,p}^{P-G} \cdot d_{k,t} \quad (3.40)$$

$$\sum_{k=1}^E I_{k,p}^{P-E} \cdot y_{k,t} + \sum_{k=1}^G I_{k,p}^{P-G} \cdot u_{k,t} \leq 1 \quad (3.41)$$

$$\sum_{k=1}^P I_{k,s}^{S-P} \cdot \delta_{k,t} = \sum_{k=1}^B I_{k,s}^{S-B} \cdot o_{k,t} + \sum_{k=1}^N I_{k,s}^{S-N} \cdot k_{k,t} + \sum_{k=1}^V I_{k,s}^{S-V} \cdot l_{k,t} \quad (3.42)$$

Energy is bought for the next 24 h period on electricity and gas DAM. In electricity DAM, bids are separated into 24 parts, one for each hour, while in gas DAM one bid is made for the entire 24 h period. The proposed industrial plant is considered to be a perfectly inelastic price taker whose bids are always accepted on DAMs. The reasoning behind this is due to prosumers small size compared to other market players (large supplying and generating companies) and overall market traded volume. Utilising elastic price taker approach is not appropriate for industrial facility and could lead to higher market risks, lower gains and losses in production. If such behaviour is to be modelled, stochastic and robust linear optimisation are not well suited. Methods like bilevel optimisation and game theory [38] are far better suited for it. Eq. (3.43) calculates needed electricity by summing all consumers and producers in each hour. Similarly, the gas volume is calculated using (3.44).

$$\pi_t = \sum_{k=1}^E \frac{a_{k,t}}{\eta_k^E} + \sum_{k=1}^P \beta_{k,t} - \sum_{k=1}^N k_{k,t}^{el} \quad (3.43)$$

$$\chi = \sum_{k=1}^T \left(\sum_{z=1}^G \frac{d_{k,z}}{\eta_k^G} + \sum_{z=1}^B h_{k,z} \right) \quad (3.44)$$

The objective function is cost minimisation of operation; in this case, it is equal to electricity and gas bought from DAM, as shown in (3.45).

$$\sum_{k=1}^T \pi_k \cdot C_k^{el} + \chi \cdot C^{gas} \quad (3.45)$$

3.2. Robust formulation

This section elaborates the formulation of robust optimisation with demand response (RO). The goal of the robust optimisation is to find minimal operational cost based on worst case scenario of electricity prices. Robust formulation of the objective function is (3.46), where $x \in X$ denotes all variables from the reference model. Electricity prices are defined as a robust set where value C_t^{el} can deviate from a reference value $C_t^{el,ref}$ by at most $\pm \Delta C_t^{el}$. The formulation is as follows: $C_t^{el} \in [C_t^{el,ref} - \Delta C_t^{el}, C_t^{el,ref} + \Delta C_t^{el}]$, $\forall t \in T$. This formulation is implemented with (3.47). The Eqs. (3.48) defines the uncertainty budget Γ , where in our case Γ can vary from 0 to T. Formulation in (3.48) is not linear so, instead of it, a set of linearised constraints will be used (3.49)–(3.51). With (3.49) and (3.50) the variation in each hour is calculated. Sum of these variations must not surpass the uncertainty budget as shown in (3.51).

$$\min_{x \in X} \chi \cdot C^{gas} + \max_{C_t^{el}} \sum_{k=1}^T \pi_k \cdot C_k^{el} \quad (3.46)$$

$$C_t^{el,ref} - \Delta C_t^{el} \leq C_t^{el} \leq C_t^{el,ref} + \Delta C_t^{el} \quad (3.47)$$

$$\sum_{k=1}^T \frac{|C_k^{el} - C_k^{el,ref}|}{\Delta C_k^{el}} \leq \Gamma \quad (3.48)$$

$$\frac{C_t^{el} - C_t^{el,ref}}{\Delta C_t^{el}} \leq \Gamma_t \quad (3.49)$$

$$-\frac{C_t^{el} - C_t^{el,ref}}{\Delta C_t^{el}} \leq \Gamma_t \quad (3.50)$$

$$\sum_{k=1}^T \Gamma_k \leq \Gamma \quad (3.51)$$

The problem can be solved by transforming the inner (maximisation) problem into its dual form. The inner problem is classified as a linear program (LP), not MILP, and as such can be easily transformed into its dual form. The transformation to dual is shown in (3.52)–(3.54). For more information on the duality theorem, we refer to [39].

$$\min \Gamma \cdot \lambda^5 + \sum_{k=1}^T (C_k^{el,ref} + \Delta C_k^{el}) \cdot \lambda_k^1 -$$

$$\sum_{k=1}^T (C_k^{el,ref} - \Delta C_k^{el}) \cdot \lambda_k^2 + \sum_{k=1}^T C_k^{el,ref} \cdot (\lambda_k^3 - \lambda_k^4) \quad (3.52)$$

$$\lambda_t^1 - \lambda_t^2 + \lambda_t^3 - \lambda_t^4 \geq \pi_t \quad (3.53)$$

$$-\Delta C_t^{el} \cdot \lambda_t^3 - \Delta C_t^{el} \cdot \lambda_t^4 + \lambda^5 \geq 0 \quad (3.54)$$

When the transformation from primal to dual problem, the objective function changes from maximisation to minimisation. Original min/max problem will then become min/min (or just min) problem which can easily be solved with of-the-shelf solvers [40]. After integrating the dual of the inner problem to the outer problem, we get the objective function as shown in (3.55).

$$\min \chi \cdot C^{gas} + \Gamma \cdot \lambda^5 + \sum_{k=1}^T (C_k^{el,ref} + \Delta C_k^{el}) \cdot \lambda_k^1 -$$

$$\sum_{k=1}^T (C_k^{el,ref} - \Delta C_k^{el}) \cdot \lambda_k^2 + \sum_{k=1}^T C_k^{el,ref} \cdot (\lambda_k^3 - \lambda_k^4) \quad (3.55)$$

The final framework of our RO problem consist of the following constraints and the objective functions: (3.1)–(3.44) and (3.53)–(3.55).

3.3. Two stage stochastic formulation

In SO, the uncertainty is modelled through scenarios and their probability of occurrence. Here we have two types of variables: first stage decision variables (here-and-now) and second stage decision variables (wait-and-see). In the first stage, the decision must be made before the realisation of uncertainty and in the second stage, we optimise the behaviour after the realisation of uncertainty. In the reference model, the first stage variables are π_t and χ , while all other variables are second-stage variables. All second-stage variables and all constraints are defined for every scenario. This means there is Ψ (where Ψ is a number of scenarios) times more second-stage variables and constraints. The objective function is formulated as shown in (3.56). The difference between RO and SO is that RO optimises based on the worst-case scenario and SO optimises based on an average scenario. Our SO problem consist of the following constraints and objective function: (3.1)–(3.44) and (3.56).

$$\sum_{z=1}^{\Psi} \sum_{k=1}^T \pi_k \cdot C_{z,k}^{el} \cdot \xi_z + \chi \cdot C^{gas} \quad (3.56)$$

3.4. Robust model without DR

This section explains the BaU model which is created to mimic the conventional, market passive operation of today's industrial plants. BaU model will use robust optimisation approach with constraints (3.53)–(3.55), so it can be easily compared to RO. BaU is built in two stages. The first stage runs the reference model which, instead of prices, has weight factors in each hour. From this, we will obtain the schedule of all processes (loads). In the second stage, we will remove constraints (3.1)–(3.25) from the reference model and we will set process load variables from the first stage as parameters. By doing this, demand in BaU model became fixed as opposed to RO and SO model where it is dynamic. Also, total demand and final product production in BaU remains the same as in RO and SO. Effectively BaU is only optimising the device schedule. The second stage of BaU model will have two cases. The first case (BaU_1) will run all the same devices as RO effectively removing demand response flexibility from it. The second case (BaU_2) will have all possibilities of shifting between energy vectors removed (same as in BaU_1), as well as demand response flexibility.

4. Case study

A generic industrial plant is designed for testing purposes based on real-world industrial plants such as [2,41–46]. The process unit chain is shown in Fig. 4. It consists of five processes and has 2 chains: 1-2-3 and 1-2-4-5. In total it has three input materials, four intermediate products and two final products. The value next to the material symbol denotes the ratio of that material to the total input or output of that process (when there are multiple inputs or outputs to a process). The length of each process is shown in Fig. 4 in brackets. Processes 1 and 3 can be interrupted for 1 h and process 4 for 2 h. Each process input is limited to 5 tonnes. The requirement for each of the two final products is 15 tonnes. Intermediate materials 2 and 3 start with 5 tonnes while the rest start with 0. There are enough input materials to produce enough final products. Each process has an electric and gas motor for satisfying motor load. The efficiencies of the electric motors are 95% and of gas motors 46.6%. The entire heating system is shown in Fig. 5. It consists of two boilers, the first with higher nominal power and more expensive starting cost and the second with lower nominal power and lower starting cost. Also, there are two turbines and valves for lowering steam pressure. Heat to power ratio of both turbines is 0.1, turbine efficiency is 98% and generator efficiency is 97%. Efficiency of both valves are 80%. Processes 1 and 5 are connected to high-pressure level (1), process 4 to medium pressure level (2) and processes 2 and 3 to low-pressure level (3). SARIMA (seasonal autoregressive integrated

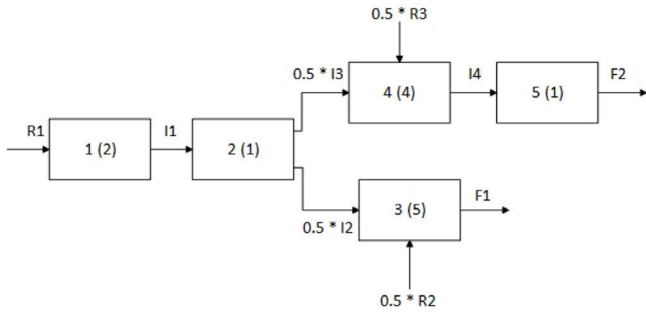

Fig. 4. Industrial processes.

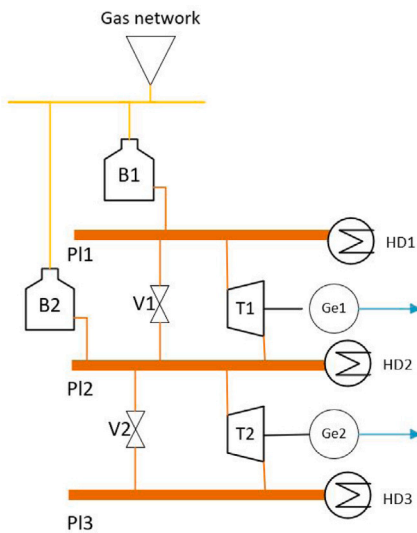

Fig. 5. Heat system.

moving average) model [47] is used to predict the DA electricity prices for Croatian Power Exchange (CROPEX) [48]. In RO and BaU, we will use a mean value and a variance between the upper and lower bound from SARIMA. Three scenarios for SO are created. They correspond to upper, mean and lower values from SARIMA with the probability of $\frac{1}{3}$ each. Four values for uncertainty budget will be used: 0 (mean values), 7 ($\approx 30\%$ variation), 17 ($\approx 70\%$ variation) and 24 (100% variation). The gas price is assumed as it can be predicted accurately and it will be used as a deterministic value of 28 €/MWh according to the statistics from [49] for Croatia.

5. Results and discussion

The model is written in Python 3.8 and it is using Gurobi 9 optimisation solver [40]. PC specifications are AMD Ryzen 5 3600 6-Core 3.59 GHz processor and 16 GB of RAM.

5.1. RO and SO comparison

First, the RO and the SO approach will be compared. Table 1 shows computational time in seconds and the value of the objective function in EUR (€) for the RO and SO approach. The number in brackets denotes the uncertainty budget in RO. We can see that the SO has a higher computational time (5–15 times) than RO due to having much higher number of variables and constraints (one set for each scenario). Usually, in SO a lot more scenarios are used, but adding more scenarios would further increase the computational time. The three scenarios used here are made solely for illustrative purposes and they correspond

Table 1
RO and SO computational time and objective function value.

	RO (0)	RO (7)	RO (17)	RO (24)	SO
Computational time (s)	145	594	1826	115	9595
Objective function (€)	10476	11892	12793	12798	10476

Table 2
Robust optimisation model with mass flow.

Uncertainty budget	0	7	18	24
Objective function (€)	10392.4	11806.5	12700.9	12709.89
Difference (%)	0.8	0.72	0.72	0.69

to the mean price scenario. RO (0) also correspond to the mean price scenario, because variance is 0%. That is why SO and RO (0) have the same objective function result. Significant decrease in computational time from RO(17) and RO(24) happens because it is harder for robust optimisation to calculate worst case scenario when variation is not 0% or 100%. Variations of 0% or 100% are closer to deterministic case in terms of computational time. Further analysis for SO are omitted because of its high computational time and the rest of the paper will focus on the RO approach.

5.2. RO results

In this chapter, the behaviour of processes and devices considering different uncertainty budgets will be showcased. In the RO model, there are two types of flexibility: from multiple energy vectors and demand response. In Fig. 6 we can see the electricity bids of RO for each uncertainty budget and in Fig. 7 the same for gas bids. In these figures, we can see how electricity and gas volumes change following the changes in the uncertainty of electricity prices. As the uncertainty rises (variation is increased), volumes of electricity are reduced in favour of gas, because it is more reliable. This happens mostly due to changes in the scheduling of electric and gas motors and is a result of multi-energy flexibility. Fig. 8 shows in what ratio are electric and gas motors used for each uncertainty budget case. Electric motors are used while uncertainty is lower and are gradually replaced with gas motors as the uncertainty increases with the biggest difference between uncertainty budget 0 and uncertainty budget 7. Fig. 9 shows how the number of active processes changes for each uncertainty budget during the day. These difference are the result of demand response (process schedule optimisation) and change to reduce the risk of uncertainty; for example in uncertainty budget 17 the number of active processes are more evenly spread out than in other cases. This trend can also be noticed in Fig. 6 since the electricity bid curve corresponds to the process schedule. In summary, multi-energy flexibility is expressed through changes in overall consumption of electricity and gas while demand response flexibility is expressed through changes in volumes/number of active processes in each hour. Lastly, robust optimisation model using mass flow (MRO) from chapter 2.2 will be compared with RO. Table 2 shows objective function cost and percentage difference for each uncertainty budget case. MRO case is less than 1% cheaper than RO and market bids are slightly changed (process schedule remains the same). The difference is mainly caused by neglecting losses as explained in chapter 2.2. Although, the difference is not major, it can still be significant as it can cause imbalance penalties on the market which can add up through time.

5.3. RO and BaU comparison

Lastly RO and BaU models will be compared. The goal is to showcase the effectiveness of DR (process sifting) and multi-energy flexibility (energy vector shifting) against business as usual approach. Figs. 10 and 11 shows electricity and gas bids for BaU_1 for each uncertainty budget. In this case, there are slight changes in the bids schedule

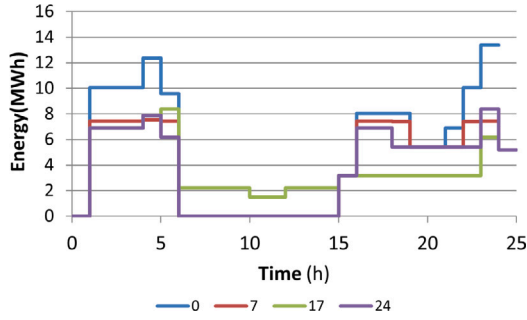

Fig. 6. Electricity bids in RO.

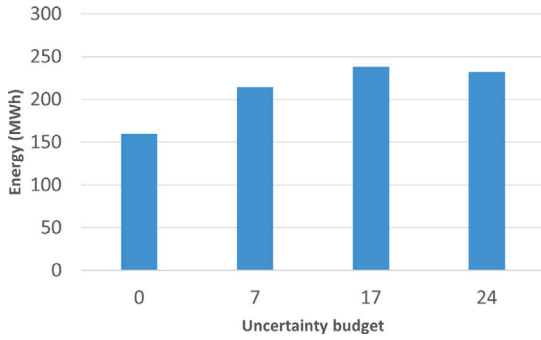

Fig. 7. Gas bids in RO.

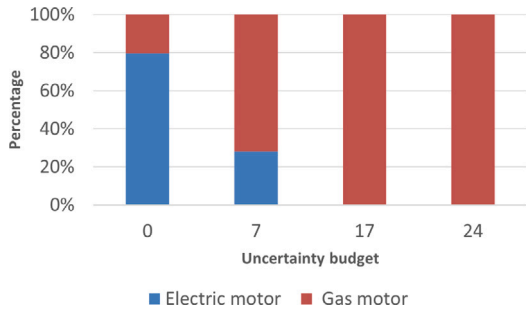

Fig. 8. Electric and gas motors rate of use.

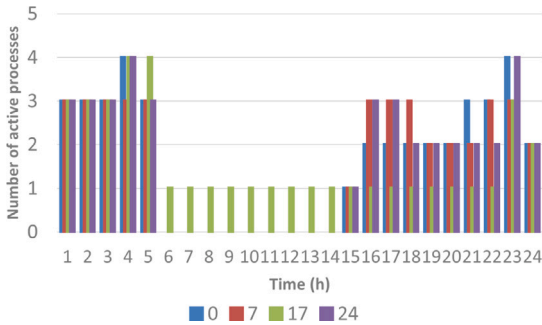

Fig. 9. Process schedule in RO.

as the uncertainty increases, as it is lowering electricity volumes in favour of gas. The schedule change exclusively comes from multi-energy flexibility such as changing electric to gas motors. BaU_1 case is trying to follow the trend from the RO model, but it lacks the flexibility to do so. Table 3 shows the objective value functions of RO, both cases of BaU and the percentage difference between them. RO outperforms BaU_1 by 7% to 11% of savings in operational costs. These savings are

Table 3
RO and BaU objective value comparison.

Uncertainty budget	0	7	17	24
RO (€)	10476	11892.62	12793.43	12798.02
BaU_1 (€)	11826.74	12862.47	13781.31	13781.31
Savings (BaU_1)	11.42%	7.54%	7.17%	7.13%
BaU_2 (€)	12805.11	13876.77	14867.55	14867.55
Savings (BaU_2)	18.19%	14.3%	13.95%	13.92%

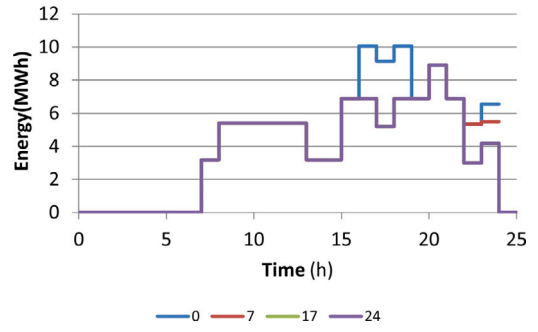

Fig. 10. Electricity bids in BaU_1 .

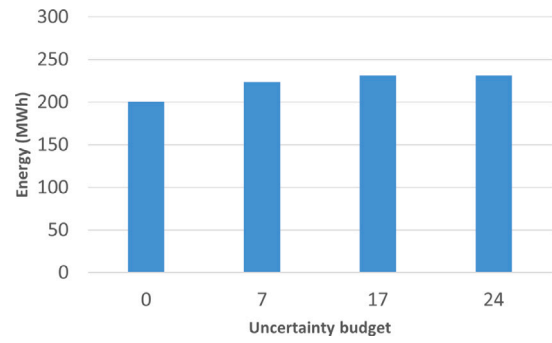

Fig. 11. Gas bids in BaU_1 .

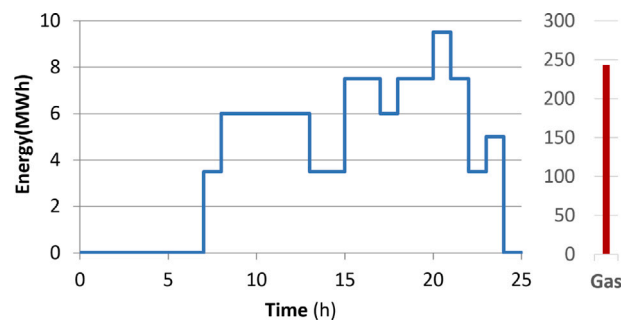

Fig. 12. Electricity and gas bids in BaU_2 .

mainly tied with demand response flexibility (i.e. load shifting). Fig. 12 shows electricity (left graph) and gas (right graph) bids for BaU_2 . Bids are the same in all cases of uncertainty budget because BaU_2 has no flexibility. The RO achieves savings of 14% to 18% when compared to BaU_2 . RO achieves These saving both due to multi-energy flexibility and inner process demand response scheduling capability. The increase in savings as compared to BaU_1 is mainly attributed to multi-energy flexibility i.e. with energy vector shifting.

6. Conclusion

The paper proposes a novel model of price responsive demand response multi-energy industrial prosumer with decomposed production processes as a way to maximise the utilisation of the DR. It is based on the scheduling of batch and continuous processes under uncertainty of day-ahead electricity market. It maintains the benefits of MILP modelling but, unlike the existing literature, takes into account the losses of the steam process and improves the mass-based model dominant in the literature to an energy flow model. This results in realistic energy flows in the industry process eventually expressed as costs savings. Two approaches are used for dealing with the uncertainty of electricity prices: robust optimisation (RO) and two-stage stochastic (SO). RO was deemed better than SO mainly because of much faster computational time. Two testing models were created to mimic the business as usual approach called BaU_1 and BaU_2 . BaU_1 model does not have any demand response flexibility and BaU_2 lacks demand response and multi-energy flexibility. The proposed robust energy flow based optimisation model, incorporating production process DR ended up being 7%–11% more cost-efficient than the BaU_1 and 14% to 18% better than the BaU_2 . These cost savings can directly translate into a reduction of costs of the industry facility products, making it more competitive in their targeted markets.

CRedit authorship contribution statement

Matija Kostelac: Term, Conceptualization, Software, Formal analysis, Investigation, Data curation, Writing – original draft, Visualization, Project administration. **Ivan Pavić:** Term, Conceptualization, Formal analysis, Investigation, Resources, Visualization, Writing – review & editing, Supervision, Project administration. **Ning Zhang:** Writing – review & editing, Supervision, Project administration. **Tomislav Capuder:** Term, Conceptualization, Formal analysis, Resources, Writing – review & editing, Supervision, Project administration, Funding acquisition.

Declaration of competing interest

The authors declare that they have no known competing financial interests or personal relationships that could have appeared to influence the work reported in this paper.

Acknowledgement

The work is supported by Croatian Science Foundation (HRZZ) and Croatian Distribution System Operator (HEP ODS) under the project IMAGINE – Innovative Modelling and Laboratory Tested Solutions for Next Generation of Distribution Networks (PAR-2018-12).

Appendix

Indicator constraints are if-then constraints. If the state of binary variable (x) is true then constraints on the right must be enforced and if x is not true then constraint is neglected from the model, as shown in (A.1). Their linear form is written using big M, where M is a big enough number. The formulation for inequality constraint on the right side is shown in (A.2). In case of equality constraint on the right side (A.3), linearised formulation is shown in (A.4) and (A.5).

$$x = 1 \rightarrow A \cdot y \leq B \quad (\text{A.1})$$

$$A \cdot y \leq B + M \cdot (1 - x) \quad (\text{A.2})$$

$$x = 1 \rightarrow A \cdot y = B \quad (\text{A.3})$$

$$A \cdot y \leq B + M \cdot (1 - x) \quad (\text{A.4})$$

$$A \cdot y \geq B - M \cdot (1 - x) \quad (\text{A.5})$$

References

- [1] Commission European. EU energy in figures - Publications Office of the EU. 2020.
- [2] Schorch Frauke, Kourti Ioanna, Scalet Bianca Maria, Roudier Serge, Sancho Luis Delgado. Best available techniques (BAT) reference document for the production of cement, lime and magnesium oxide. European commission. 2013, p. 2013.
- [3] ENTSO-E. All TSOs' proposal to further specify and harmonise imbalance settlement in accordance with Article 52(2) of the Commission Regulation (EU) 2017/2195 of 23 November 2017 establishing a guideline on electricity balancing. 2019.
- [4] ENTSO-E. ENTSO-E Balancing reports. Technical report, 2020, <https://www.entsoe.eu/news/2020/06/30/2020-entso-e-market-reports/>.
- [5] Eicke Anselm, Ruhnau Oliver, Hirth Lion. Electricity balancing as a market equilibrium: An instrument-based estimation of supply and demand for imbalance energy. *Energy Econ* 2021;102:105455.
- [6] Morales González Juan Miguel, Conejo Antonio J, Madsen Henrik, Pinson Pierre, Zugno Marco. Integrating renewables in electricity markets: Operational problems. *International series in operations research and management science*, Springer; 2014.
- [7] Shahidepour M, Yamin H, Li Z. Market overview in electric power systems. In: *Market operations in electric power systems: forecasting, scheduling, and risk management*. 2002, p. 1–20.
- [8] Beus Mateo, Pavić Ivan, Štrif Ivan, Capuder Tomislav, Pandžić Hrvoje. Electricity market design in Croatia within the European electricity market—Recommendations for further development. *Energies* 2018;11(2).
- [9] Pavić I, Beus M, Pandžić H, Capuder T, Štrif I. Electricity markets overview — Market participation possibilities for renewable and distributed energy resources. In: 2017 14th international conference on the European energy market. 2017, p. 1–5.
- [10] ENTSO-E. ENTSO-E market reports. Technical report, 2020, <https://www.entsoe.eu/news/2020/06/30/2020-entso-e-market-reports/>.
- [11] Arias Luis Alejandro, Rivas Edwin, Santamaria Francisco, Hernandez Victor. A review and analysis of trends related to demand response. *Energies* 2018;11(7).
- [12] Paterakis Nikolaos G, Erdinç Ozan, Catalão João PS. An overview of demand response: Key-elements and international experience. *Renew Sustain Energy Rev* 2017;69:871–91.
- [13] Albadi M H, El-Saadany E F. Demand response in electricity markets: An overview. In: 2007 IEEE power engineering society general meeting. 2007, p. 1–5.
- [14] Misconel Steffi, Zöphel Christoph, Möst Dominik. Assessing the value of demand response in a decarbonized energy system – a large-scale model application. *Appl Energy* 2021;299:117326.
- [15] Heffron Raphael, Körner Marc-Fabian, Wagner Jonathan, Weibelzahl Martin, Fridgen Gilbert. Industrial demand-side flexibility: A key element of a just energy transition and industrial development. *Appl Energy* 2020;269:115026.
- [16] Jiang Z, Hao R, Ai Q, Yu Z, Xiao F. Extended multi-energy demand response scheme for industrial integrated energy system. *IET Gener Transm Distrib* 2018;12(13):3186–92.
- [17] Yeo Yeong-Koo, Roh Hang-Duk, Kim In-Won, Moon II, Chung Yonsoo. Optimal operation of utility systems in petrochemical plants. *Korean J Chem Eng* 2003;20:200–6.
- [18] de Magalhães Eduardo G, Fronza Tiago, Wada Keiko, Secchi Argimiro R. Steam and power optimization in a petrochemical industry. *IFAC Proc Vol* 2006;39(2):839–44.
- [19] Mitra Sumit, Sun Lige, Grossmann Ignacio E. Optimal scheduling of industrial combined heat and power plants under time-sensitive electricity prices. *Energy* 2013;54:194–211.
- [20] Agha Mujtaba H, They Raphael, Hetreux Gilles, Hait Alain, Le Lann Jean Marc. Integrated production and utility system approach for optimizing industrial unit operations. *Energy* 2010;35(2):611–27, ECOS 2008.
- [21] Luo Xianglong, Zhang Bingjian, Chen Ying, Mo Songping. Modeling and optimization of a utility system containing multiple extractions steam turbines. *Energy* 2011;36(5):3501–12.
- [22] Li Zeqiu, Du Wenli, Zhao Liang, Qian Feng. Modeling and optimization of a steam system in a chemical plant containing multiple direct drive steam turbines. *Ind Eng Chem Res* 2014;53(27):11021–32.
- [23] Varbanov PS, Doyle S, Smith R. Modelling and optimization of utility systems. *Chem Eng Res Des* 2004;82(5):561–78.
- [24] Gholian A, Mohsenian-Rad H, Hua Y. Optimal industrial load control in smart grid. *IEEE Trans Smart Grid* 2016;7(5):2305–16.
- [25] He Sheng, Chen Songsong, Gong Feixiang, Yang Shihai, Zhou Ying, Chi Qingqing. Research on modeling method of industrial load controllable characteristics based on multi-objective optimization method algorithm. In: 2021 7th International symposium on mechatronics and industrial informatics. 2021, p. 193–6.
- [26] Gholian A, Mohsenian-Rad H, Hua Yingbo, Qin Joe. Optimal industrial load control in smart grid: A case study for oil refineries. In: 2013 IEEE power energy society general meeting. 2013, p. 1–5.

- [27] Zhang Cuo, Xu Yan, Dong Zhao Yang, Yang Lin Feng. Multitimescale coordinated adaptive robust operation for industrial multienergy microgrids with load allocation. *IEEE Trans Ind Inf* 2020;16(5):3051–63.
- [28] Madhavan Adarsh, Lee Brian, Cañizares Claudio A, Bhattacharya Kankar. A smart voltage optimization approach for industrial load demand response. In: 2019 IEEE Milan powertech. 2019, p. 1–6.
- [29] Holjevac Ninoslav, Capuder Tomislav, Zhang Ning, Kuzle Igor, Kang Chongqing. Corrective receding horizon scheduling of flexible distributed multi-energy microgrids. *Appl Energy* 2017;207:176–94, Transformative Innovations for a Sustainable Future – Part II.
- [30] Almassalkhi M R, Towle A. Enabling city-scale multi-energy optimal dispatch with energy hubs. In: 2016 power systems computation conference. 2016, p. 1–7.
- [31] Prékopa András. Stochastic programming. Dordrecht: Springer Netherlands; 1995.
- [32] Birge John R, Louveaux François. Introduction To Stochastic Programming. Springer Series in Operations Research and Financial Engineering, New York, NY: Springer New York; 2011.
- [33] Conejo Antonio J, Carrión Miguel, Morales Juan M. Decision making under uncertainty in electricity markets. In: Journal of the operational research society. International series in operations research & management science, vol. 153, (1); Boston, MA: Springer US; 2010, p. 174.
- [34] Ben-Tal Aharon, Nemirovski Arkadi. Selected topics in robust convex optimization. *Math Program* 2008;112:125–58.
- [35] Ben-Tal A, El Ghaoui L, Nemirovski AS. Robust optimization. Princeton series in applied mathematics, Princeton University Press; 2009.
- [36] Bertsimas Dimitris, Brown David B, Caramanis Constantine. Theory and applications of robust optimization. 2010.
- [37] Todd DeWayne, Caufield Michael, Helms Brian, Starke Michael R, Kirby Brendan J, Kueck John D. Providing reliability services through demand response: A preliminary evaluation of the demand response capabilities of Alcoa Inc. Technical report, 2009.
- [38] Gržanić Mirna, Capuder Tomislav. Coordinated scheduling of renewable energy balancing group. *Int J Electr Power Energy Syst* 2021;125:106555.
- [39] Boyd Stephen, Vandenberghe Lieven. Convex optimization. Cambridge University Press; 2004.
- [40] Gurobi Optimization, LLC. Gurobi optimizer reference manual. 2021.
- [41] Suhr Michael, Klein Gabriele, Kourti Ioanna, Rodrigo Gonzalo Miguel, Giner Santonja Germán, Roudier Serge, Delgado Sancho Luis. Best available techniques (BAT) reference document for the production of pulp, paper and board. 2015.
- [42] Santonja German Giner, Karlis Panagiotis, , Brinkmann Thomas, Roudier Serge. Best available techniques (BAT) reference document on food, drink and milk industries. In: European commission. 2019, p. 1–820.
- [43] Brinkmann Thomas, Giner Santonja Germán, Schorcht Frauke, Roudier Serge, Delgado Sancho Luis. Best available techniques reference document for the production of Chlor-alkali. 2014.
- [44] Remus Rainer, Roudier Serge, Aguado-Monsonet Miguel A, Delgado Sancho Luis. Best available techniques - iron and steel production. In: Industrial Emissions Directive 2010/75/EU, vol. BREF-IS. 2013, p. 597.
- [45] Cusano Gianluca, Gonzalo Miguel Rodrigo, Farrell Frank, Remus Rainer, Roudier Serge, Sancho Luis Delgado. Best available techniques (BAT) reference document for the non-ferrous metals industries. 2017, p. 1233.
- [46] He Kun, Wang Li. A review of energy use and energy-efficient technologies for the iron and steel industry. *Renew Sustain Energy Rev* 2017;70:1022–39.
- [47] Kumar Vipin, Singh Nitin, Singh Deepak Kumar, Mohanty SR. Short-term electricity price forecasting using hybrid SARIMA and GJR-GARCH model. In: Perez Gregorio Martinez, Mishra Krishn K, Tiwari Shailesh, Trivedi Munesh C, editors. Networking communication and data knowledge engineering. Singapore: Springer Singapore; 2018, p. 299–310.
- [48] CROATIAN ENERGY EXCHANGE - CROATIAN ENERGY EXCHANGE Ltd. - cropex.hr.
- [49] EU-28: industrial prices of natural gas 2019 | Statista, <https://www.statista.com/statistics/1047083/natural-gas-price-european-union-country/>.

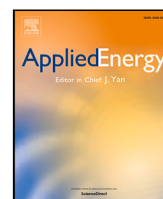

Economic and environmental valuation of green hydrogen decarbonisation process for price responsive multi-energy industry prosumer

Matija Kostelac^{a,*}, Ivan Pavić^b, Tomislav Capuder^a

^a University of Zagreb Faculty of Electrical Engineering and Computing, Zagreb, Croatia

^b SnT – Interdisciplinary Centre for Security, Reliability and Trust, University of Luxembourg, Luxembourg City, Luxembourg

ARTICLE INFO

Keywords:

Green hydrogen
Multi-energy systems
Industry facility
PV generation
Price-responsive flexibility

ABSTRACT

Carbon neutrality is one of the main goals in current power system planning and operation. Many different actions and solutions are presented and implemented so far, incorporating renewable energy sources at all levels of the system. With the raising prices of natural gas and its negative impact on the environment, particularly emphasised over the past two years, new technologies and energy vectors are emerging as potential for its replacement. High importance of the hydrogen energy vector, especially in the decarbonisation of the industry sector, is being put forward due to its advantages of zero greenhouse gas emissions, its capacity for storing energy and capability to balance the production of renewable energy sources. This paper brings a detailed mathematical model of a price driven, demand responsive, multi-energy industry facility, as a logic first implementer of hydrogen technologies due to its high and multi-energy consumption nature. The systematic analyses are conducted over a set of scenarios of local production, considering different hydrogen technologies as well as range of natural gas and electricity prices. The findings of the paper conclude that hydrogen technology implementation into a realistic industrial consumers processes results in zero local emissions production, high level of autonomy and resistance from the market disturbances. When compared with classic industrial layouts, the overall CO₂ footprint is reduced from around 30% to around 85%, depending on the scenario. The sensitivity analysis has proven that hydrogen layouts are comparable to natural gas layouts in terms of total costs, showing that hydrogen options result in lower cost in the range from 25% to 58%, depending on the observed scenario.

1. Introduction

Industry is one of the three dominant categories by final energy consumption in European union, making up around 25% [1]. Industrial facilities are complex systems composed of various processes for refinement from raw materials to final products, usually consuming various forms of energy such as natural gas, electricity and multiple pressure levels of steam or hot water for heat consuming processes. Traditionally, energy required to cover consumption is mostly procured from the external sources and is in smaller capacity produced locally. Being characterised by high energy usage, industrial facilities are responsible for large amount of emissions either indirectly from electricity purchase (emissions produced from electricity generation) or directly from locally consumed fossil fuel. Current climate law of European Union plans to achieve climate neutrality by 2050 for which emissions should have to be lowered by at least 55% by 2030 [2]. Direct emissions produced in industrial facilities can be reduced by replacing fossil fuels with some other energy vector with lower, or

none whatsoever, emissions production. One such emerging energy vector is hydrogen [3]. It can be produced locally from electricity and can replace fossil fuels in local heat and electricity production [4]. These are not the only benefits as it can be used as effective energy storage; moreover some chemical and petrochemical industrial facilities already possess electrolyzers since hydrogen is used as an input into their processes [5,6]. Although this approach negates local emissions, at the same time it creates higher electricity demand which in return increases indirect emissions. To circumnavigate this, in this paper, we introduced local renewable energy generation in terms of photovoltaic (PV) system [7]. Intermittent and unpredictable nature of PV system can be partially mitigated by cooperation with hydrogen technologies [8] and industrial system management. In this paper, hydrogen provides flexibility through energy storage while industrial system processes have the capability to react as price-responsive demand response [9] meaning the product refinement can be rescheduled to complement the rest of the system when required.

* Corresponding author.

E-mail address: matija.kostelac@fer.hr (M. Kostelac).

Nomenclature

$\alpha_{p, t}$	Number of time process p has started up to time t
$\beta_{p, t}$	Electrical load of process p at the time t [MWh]
χ	Gas bought on the market [MWh]
$\chi_{b, t}$	Gas input of boiler b at the time t [MW]
$\delta_{p, t}$	Heating load of process p at the time t [MWh]
$\epsilon_{b, t}$	Indicate whether the gas boiler b operate at time t
η_e^E	Efficiency of electrolyser e
$\eta_g^{G,el}$	Electric efficiency of fuel cell g
$\eta_g^{G,h}$	Heating efficiency of fuel cell g
η_h^H	Efficiency of hydrogen boiler h
$\gamma_{p, t}$	Hydrogen load of process p at the time t [MWh]
$l_{p, t}$	Indicate whether the process p is interrupted at the time t
$\kappa_{b, t}$	Indicate whether the gas boiler b started from warm state at time t
$\mu_{p, t}$	Amount of materials inside process p at the time t [t]
$\nu_{b, t}$	Indicate whether the gas boiler b started from cold state at time t
$\omega_{p, t}$	Number of time process p has ended up to time t
$\bar{\mu}_{p, t}$	Material that entered process p at the time t [t]
\bar{h}_t	Input to hydrogen storage at the time t [MW]
ϕ_t	Volume of hydrogen stored at the time t [MWh]
π_t	Electricity bought/sold on the market at time t [MWh]
$\sigma_{i, t}$	Storage of initial material i at the time t [t]
$\tau_{r, t}$	Storage of intermediate material r at the time t [t]
$\theta_{b, t}$	Indicate whether the gas boiler b is in cold state at time t
$\frac{\mu}{p}, t$	Material that left process p at the time t [t]
$\frac{h}{t}$	Output to hydrogen storage at the time t [MW]
$\nu_{f, t}$	Storage of final product f at the time t [t]
$\zeta_{b, t}$	Indicate whether the gas boiler b is in warm state at time t
$a_{e, t}$	Output power of electrolyser e at the time t [MW]
B, b	Set and index for each gas boiler
B_b^{cdt}	Time needed for gas boiler b to cool down [h]
B_b^{cs}	Additional gas needed to star boiler b from cold state [MWh]
B_b^k, B_b^l	Slope and y-intercept for gas-to-heat conversion of boiler b
B_b^{ws}	Additional gas needed to star boiler b from warm state [MWh]
C_t^{el}	Price of electricity in hour t [€/MWh]
C^{gas}	Price of gas [€/MWh]
$d_{g, t}$	Input power of fuel cell g at the time t [MW]
E, e	Set and index for each electrolyser
F, f	Set and index for each final product
G, g	Set and index for each fuel cell
H, h	Set and index for each hydrogen boiler
I, i	Set and index for each intermediate material

$I_{f, p}^{PI-F}$	Process input-final material coefficient matrix
$I_{r, p}^{PI-I}$	Process input-intermediate material coefficient matrix
$I_{i, p}^{PI-R}$	Process input-raw material coefficient matrix
$I_{f, p}^{PO-F}$	Process output-final material coefficient matrix
$I_{r, p}^{PO-I}$	Process output-intermediate material coefficient matrix
$I_{i, p}^{PO-R}$	Process output-raw material coefficient matrix
$o_{b, t}$	Output power of gas boiler b at the time t [MW]
P, p	Set and index for each process
$P_p^{I, max}$	Maximum input of a process [t]
$P_p^{I, min}$	Minimum input of a process [t]
P_p^I	Length of process i [h]
P_p^{DI}	Length of interruption of process i [h]
$P_p^{El,k}, P_p^{El,l}$	Slope and y-intercept for electric load of process p
$P_p^{El,D}$	Electric load of process p when interrupted [MWh]
$P_p^{Hl,k}, P_p^{Hl,l}$	Slope and y-intercept for heat load of process p
$P_p^{Hl,D}$	Heat load of process p when interrupted [MWh]
$P_p^{Ml,k}, P_p^{Ml,l}$	Slope and y-intercept for hydrogen load of process p
PV_t	Production from photovoltaic in time t [MWh]
R, r	Set and index for each raw material
$S_f^{F, max}$	Maximum storage of final product f [t]
$S_f^{F, min}$	Minimum storage of final product f [t]
$S_f^{f, goal}$	Amount of final product f needed [t]
$S_i^{I, max}$	Maximum storage of intermediate material i [t]
$S_i^{I, min}$	Minimum storage of intermediate material i [t]
$S_i^{I,0}$	Initial storage state of intermediate material i
$S_r^{R, max}$	Maximum storage of raw material r [t]
$S_r^{R, min}$	Minimum storage of raw material r [t]
T, t	Set and index for each time step
$\nu_{h, t}$	Output power of hydrogen boiler h at the time t [MW]
$x_{p, t}$	Indicate whether the process p operate at time t

In this paper, we analyse a realistic industrial facility designed as a price-responsive demand response system, with installed hydrogen technologies and a photovoltaic renewable energy system in order to lower its emissions and environmental impact.

1.1. Relevant literature analysis

Although hydrogen as an energy vector is not a new concept, its usage has greatly increased as a substitute for fossil fuels over the past couple of years [10]. Hydrogen technologies have found wide variety of usage in energy markets. Great emphasis in the literature is placed on hydrogen as an energy storage [11], from its feasibility as a clean technology [12] to usage of various different hydrogen technologies [13]. Lagioia et al. [14] finds European hydrogen roadmap difficult to implement in a short-term as there are technical and infrastructure

barriers in large-scale application, although they do believe that hydrogen technologies will find usage in heavy industry and heavy-duty transport. Similarly, the authors in [15] recognise importance of green hydrogen in decarbonisation of industrial sector and provides overview of country potential in production and industrial application of green hydrogen.

The research body presented here recognises the importance of hydrogen as an energy vector and its cooperation with renewable energy sources. Lebrouhi et al. [16] provides an overview on current development on hydrogen as an energy vector from technological and geopolitical viewpoint. According to their prediction around 60% of all GHG (greenhouse gas) emission reduction will come from renewables, green hydrogen and low carbon electrification. Amin et al. [17] analyse hydrogen production from renewable and non-renewable energy sources and their impact on environment. Paper [18] proposes a 100% renewable microgrid using hydrogen-based long-term storage. It provides the methodology for operation and finding the best sizing values for such a system. Integration of hydrogen technologies into the energy system is proposed in [19]. The paper discusses the integration of power to hydrogen and heat with seasonal hydrogen storage in a system with very high renewable energy penetration. The flexibility of hydrogen system is showcased by considering generation-load uncertainties and N-1 contingency of crucial devices. Miljan et al. [20] propose a profit maximisation model, cast as a bilevel algorithm, where the operation of a large scale battery storage system and electrolyser is optimised for day-ahead electricity market participation while simulating market clearing in the lower level. The paper analysed profits and utilisation for different sets of installed power capacities. Another important role of hydrogen is its use in heat production as it provides an alternative to fossil fuel usage. Samastil et al. [21] examine possibilities of green hydrogen in heat production in order to decarbonise heat demand sector in Great Britain. Their results have shown that there is potential for 20% of heat production from hydrogen. It should be noticed that majority of the analyses mentioned above focus on local production of hydrogen as transmission and procurement of hydrogen is a complex problem and some of the prominent solutions suggest using natural gas grid for hydrogen transportation [22]. With this in mind, there are opportunities opening for design of the hydrogen market where some aspects could follow the natural gas market design logic. In the line with this, Pavic et al. [23] consider a complex system with hydrogen technologies, RES and battery storage system in a multi market environment. They consider natural gas, electricity and hydrogen market while also providing ancillary services for the system operator in the form of automatic frequency restoration reserve. Hydrogen technologies will have a major impact on the energy market in the future, but based on the existing literature review, additional research is necessary.

The second identified gap focuses on maximising the benefits of hydrogen's role in industry facilities acting as active market participants, relying on hydrogen in both its inner processes and reducing energy costs by adjusting its interactions with energy systems driven by market prices. Industrial plants are energy-intensive and centralised consumers, meaning that they do not necessarily require any kind of aggregation, unlike smaller consumers [24]. They usually contain a certain degree of automatisisation making them easier to operate. With this in mind, they are prime targets for implementation of demand-side flexibility [25], however, there is ample room for improvement in the literature [26]. The possibilities of demand-side management in metal casting industries are presented in [27], based on the day-ahead electricity market scheduling model and reserve provision. Similarly, [28] showcased the economic benefits of pulp and paper industries in the regulating power market as means to balance the ever-increasing share of renewable energy sources. The conclusions of the paper are that economic factors should be addressed when assessing the technical or theoretical possibilities to participate in DR program. Wang et al. [29] provide a framework for day-ahead

scheduling and contract following with real-time demand response management. The industrial system observed in the paper is chlor-alkali production with a hydrogen production system and photovoltaic thermal system. Shoreh et al. [30] provide a detailed analysis of the possibilities of demand response programs in different industries. The methodology for industrial demand response based on batch process scheduling is presented in [31]. It is based on different smart pricing schemes such as time-of-use and peak pricing. A similar model is adapted to a real-world industrial plant by the same authors in [32]. Paper [33] provides detailed analysis and development status in hydrogen integration in the iron and steel industry. They report that up to 95% of CO₂ emissions reduction can be achieved by replacing classic coal blast furnaces with hydrogen. A detailed study was carried out for potential switches between these technologies with a conclusion that there are still challenges to overcome. On the other hand, they anticipate that by 2035 hydrogen technologies would be an important factor in industry decarbonisation. Techno-economic feasibility analysis for alternative hydrogen production from methane pyrolysis in steel-making industrial process is presented in [34] and compared to the classic electrolyser approach. The analysis yielded similar results for methane pyrolysis and electrolyser, concluding that both approaches are feasible, but noting that total emission for electrolyser is lower in systems with low emission energy mix.

Based on the above, the authors have recognised a research gap as hydrogen in industrial application is still sparsely researched topic. Some papers focus on different aspects of hydrogen but look at them individually, from its energy storage capabilities [35], electricity and heat production potential [36], industrial process utilisation [37] or emissions reduction potential [38]. Besides focusing on the above-mentioned topics, the paper will also explore environmental and economic benefits that can be achieved through market participation and renewable energy integration. Merging them into cohesive narratives to fill the gaps in the literature, which in our opinion, has not been well researched until this point. It needs to be noted that replacing natural gas and the entire gas infrastructure, from pipelines, boilers, etc., with hydrogen infrastructure includes multiple technical challenges and issues which have not yet been adequately researched to the author's best knowledge, as there is still not sufficient empirical evidence from the plants. Energy systems within industrial facilities are independent systems as they do not interfere significantly with industrial processes except on the points of transferring energy to the processes, so those challenges should not be insurmountable in practice. The authors acknowledge those challenges, from technical to security perspectives, and they need to be fully understood in the case of the proposed energy transition, however, this is out of the scope of the paper.

1.2. Contribution and organisation

In this paper, as two main scientific contributions, we:

- Propose a linear model of price-responsive demand response based industrial system scheduling with green hydrogen as an energy vector and photovoltaic renewable energy system,
- Define the economic breaking points for energy transition of fossil fuel driven industrial facility using green hydrogen and renewable sources.

The remaining of the paper is organised as follows. Section 2 provides concept and mathematical framework. Section 3 provides the case study. Section 4 discusses emissions reducing possibilities and Section 5 provides economic analysis. Finally, Section 6 concludes the paper.

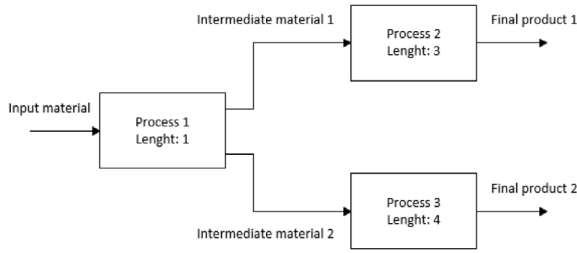

Fig. 1. Generic industrial process scheme.

2. Mathematical framework and concept

2.1. Concept

The presentation of the developed model is conceptually separated into two parts. The first part describes the processes which simulate industrial plant operation. The idea is that the entire product refinement from raw materials to end-product is simulated with various intermediate steps. From the perspective of this paper, these processes represent plant's consumption of energy. They can be optimally scheduled throughout optimisation horizon based on chosen objective function. This means that the consumption can be shifted and we can classify this part of the model as a price responsive demand response. Fig. 1 shows an example of the process scheme for an industrial plant. It contains three processes: one raw (input) material, two intermediate materials and two final products. Raw material is refined in process 1 into intermediate materials which are later on refined by process 2 and 3 into final products. Processes can have different lengths as shown in Fig. 1. Process with length of one is considered continuous which means that it produces outputs in every time step. Other processes are batch, meaning that they require more time steps to produce an output (i.e. inputs are taken in time step "N" and outputs are generated "l" time step later, where "l" is the length of batch process). Second part of the model deals with scheduling of the devices used to satisfy consumption of the processes. The devices can be powered by different energy vectors, meaning the model can optimise shifting between electricity and natural gas as fuels in order to minimise the total cost and showcase the differences. However, the goal of the developed model is to clearly identify the conditions in which full electrification of the industrial plant is possible and financially feasible, using hydrogen technologies and renewable energy sources. Detailed mathematical model is explained in the following section.

2.2. Mathematical model

In the proposed model one optimisation step is equal to one hour and the optimisation horizon varies depending on the scenario. A detailed demand model of an industrial plant with process scheduling is described further in this section. All continuous variables are positive unless stated otherwise.

Eqs. (1) and (2) calculate the number of times that batch/continuous cycles have started/finished at a specific time for the entire optimisation horizon using variables α and ω . In other words, if the length of the process is 2 h and at time t it has been running for 3 h in total, the start variable α will contain the value of 2 and the finish variable ω will be 1. Materials are inputted into the process to be refined into usable outputs. Process input can only be taken at the beginning of the batch cycle and outputted only at the end. The minimum and maximum amount of inputs is limited with constraints (3) and (4), where the difference " $\alpha_{p,t} - \alpha_{p,t-1}$ " denotes whether the process has started or not. Variable $\mu_{p,t}$ is used to track the volume of materials currently being refined by the process which is enforced with constraint (5). This is important due to dependency of other variables in the model on its

value (e.g. process consumption). Eqs. (6) and (7) set the total process output at its end. Total output is always equal to total input, but the input can be separated on multiple processes or even be noted as loss based on the given parameters. Similar to the start, end of the process is denoted with the expression " $\omega_{p,t} - \omega_{p,t-1} = 1$ ". These two constraints are if-then constraints, called indicator constraints, implemented in the used Gurobi solver [39]. In short, if the term on the left side is true then the constraint on the right side must be enforced, and if it is false the constraint is not enforced. Process outputs are finalised at the end of time t which is modelled as the beginning of the next time step $t + 1$.

$$(\alpha_{p,t-1}) \cdot P_p^l + 1 \leq \sum_{k=1}^t x_{p,k} \leq \alpha_{p,t} \cdot P_p^l \quad (1)$$

$$\omega_{p,t} \cdot P_p^l \leq \sum_{k=1}^t x_{p,k} \leq (\omega_{p,t+1}) \cdot P_p^l - 1 \quad (2)$$

$$\bar{\mu}_{p,t} \leq P_p^{l, \max} \cdot (\alpha_{p,t} - \alpha_{p,t-1}) \quad (3)$$

$$\bar{\mu}_{p,t} \geq P_p^{l, \min} \cdot (\alpha_{p,t} - \alpha_{p,t-1}) \quad (4)$$

$$\mu_{p,t} = \mu_{p,t-1} + \bar{\mu}_{p,t} - \underline{\mu}_{p,t} \quad (5)$$

$$\omega_{p,t} - \omega_{p,t-1} = 1 \rightarrow \underline{\mu}_{p,t+1} = \mu_{p,t} \quad (6)$$

$$\omega_{p,t} - \omega_{p,t-1} = 0 \rightarrow \underline{\mu}_{p,t+1} = 0 \quad (7)$$

During the production some processes can be interrupted for a certain amount of time, i.e. their production can be shifted without endangering progress or impacting the quality of the end product. Considering this, the process must always be in one of the three possible states (off mode, operation mode or interrupted mode). After the process has started its operation it must be either in operation mode ($x_{p,t} = 1$) or in interrupted mode ($i_{p,t} = 1$) until it is finished, else it is in off mode where both variables are equal to "0". To convey this behaviour, Eqs. (8)–(10) are introduced. Eq. (8) ensures that the process can only be interrupted when it is running, (9) ensures that the process is either running or is interrupted and (10) ensures that if the process is running at least one of the binary variables, $i_{p,t}$ or $x_{p,t}$, must be equal to 1. Eq. (11) defines the maximum length for process interruption at the start of each batch cycle.

$$i_{p,t} \leq \alpha_{p,t} - \omega_{p,t} \quad (8)$$

$$i_{p,t} + x_{p,t} \leq 1 \quad (9)$$

$$i_{p,t} + x_{p,t} \geq \alpha_{p,t} - \omega_{p,t} \quad (10)$$

$$\alpha_{p,t} - \alpha_{p,t-1} = 1 \rightarrow \sum_{k=t}^{t+P_p^l+P_p^{DI}} i_{p,k} \leq P_p^{DI} \quad (11)$$

The load of the process depends on the state of the process at each time step: off, operational or interrupted mode. While in the operation state, the process is producing/refining the product and its consumption is linearly dependent on the volume of material the process is working on. The interrupted state considers that the process has started but was halted in order to shift demand. In this state, the process can have a fixed predefined consumption which is needed so the progress of the process is not lost. For example in aluminium production, the temperature must not fall below a certain threshold, so heating energy is needed [40]. Each process can have 3 types of load needed for product refinement, whether it is electricity to power devices such as motors and assembly lines, heat for smelting or hydrogen for chemical processing. Eqs. (12), (14) and (15) calculate the electrical, hydrogen and heating load when the process is in operation, respectively. If the process is interrupted fixed load is calculated with (13) and (16). When the process contains hydrogen load we consider it as an exothermic process that can be captured with a heat exchanger. This means that its heat consumption becomes heat production. In this case corresponding variable is initialised as a non-positive and Eq. (15) is multiplied with "−1".

$$x_{p,t} = 1 \rightarrow \beta_{p,t} = \mu_{p,t} \cdot P_p^{El,k} + P_p^{El,l} \quad (12)$$

$$l_{p,t} = 1 \rightarrow \beta_{p,t} = P_p^{El,D} \quad (13)$$

$$x_{p,t} = 1 \rightarrow \gamma_{p,t} = \mu_{s,p,t} \cdot P_p^{MI,k} + P_p^{MI,l} \quad (14)$$

$$x_{p,t} = 1 \rightarrow \delta_{p,t} = \mu_{p,t} \cdot P_p^{HI,k} + P_p^{HI,l} \quad (15)$$

$$l_{p,t} = 1 \rightarrow \delta_{p,t} = P_p^{HI,D} \quad (16)$$

The proposed model considers two types of materials: raw and intermediate materials. Both can be supplied to the process as input. The raw material is acquired beforehand, while intermediate material is produced in one of the processes within the observed plant and can be used in another process. Final products are process materials that do not need further refinement. Minimum and maximum available material storage is defined with (17), (19) and (21). If an intermediate material cannot be stored, minimum and maximum values are set to 0, which means that the material must be used immediately after it is produced. Eqs. (18), (20) and (22) connect storage (raw materials, intermediate materials and final products respectively) with inputs and outputs from the processes. Coefficients in "I" matrices used in mentioned equations correspond to the ratio of materials; for example, if process 1 takes raw materials 1 and 2 in ratio 60% and 40%, coefficients will be $I_{1,1}^{PI-R} = 0.6$ and $I_{2,1}^{PI-R} = 0.4$. The coefficients for other materials and products, not used by this process, will be zero. Each storage has a defined initial value (set in the hour 0). Both intermediate and final storage levels are defined for every $t \in (T+1)$ so that the process that has finished in the last hour T can output their products in hour $T+1$. No other action takes place at the time $T+1$. The initial value of the intermediate materials must be at least equal to the intermediate material in the hour $T+1$ as shown in (23). The final product has the required volume that needs to be produced at the end of the optimisation horizon ($T+1$) defined by (24). Additionally, the optimisation can be split into multiple days where the above constraints can be defined for the end of each day instead for the entire optimisation horizon.

$$S_i^{R,min} \leq \sigma_{r,t} \leq S_i^{R,max} \quad (17)$$

$$\sigma_{r,t} = \sigma_{r,t-1} - \sum_{k=1}^P I_{r,k}^{PI-R} \cdot \bar{\mu}_{k,t} + \sum_{k=1}^P I_{r,k}^{PO-R} \cdot \underline{\mu}_{k,t} \quad (18)$$

$$S_r^{I,min} \leq \tau_{i,t} \leq S_r^{I,max} \quad (19)$$

$$\tau_{i,t} = \tau_{i,t-1} - \sum_{k=1}^P I_{i,k}^{PI-I} \cdot \bar{\mu}_{k,t} + \sum_{k=1}^P I_{i,k}^{PO-I} \cdot \underline{\mu}_{k,t} \quad (20)$$

$$S_f^{F,min} \leq v_{f,t} \leq S_f^{F,max} \quad (21)$$

$$v_{f,t} = v_{f,t-1} - \sum_{k=1}^P I_{f,k}^{PI-F} \cdot \bar{\mu}_{k,t} + \sum_{k=1}^P I_{f,k}^{PO-F} \cdot \underline{\mu}_{k,t} \quad (22)$$

$$\tau_{f,T+1} \geq S^{I,0} \quad (23)$$

$$v_{f,T+1} \geq S^F, \min \quad (24)$$

The industrial facility can satisfy the process consumption by using various devices. Electricity consumption can be satisfied by purchasing it from the electricity market or by generating it locally. Hydrogen consumption is satisfied using local hydrogen production. Heat is also produced locally from various technologies that will be presented later in the paper. All of these devices in the model use at least four general constraints. Two of those constraints limit the minimum and maximum output power as shown in (25), except in case of the fuel cell where input power is constrained. The other two constraints are for minimum and maximum ramp rate of the device, shown in (26) and (27). Variables and parameters for the electrolyser are used as an example for these general constraints. Hydrogen storage is a bit more specific. It still retains Eq. (25) for its input and output power in this form. Maximum and minimum volume of hydrogen that can be stored (SOH, state of hydrogen) is modelled to be equal to (25), but without binary variables. Additionally, it requires a constraint (28) for tracking

the stored hydrogen. Also, it requires that the initial value is set and that the SOH in the last hour is the same as initially set.

$$E_{e,t}^{min} \cdot y_{e,t} \leq a_{e,t} \leq E_{e,t}^{max} \cdot y_{e,t} \quad (25)$$

$$a_{e,t} - a_{e,t-1} \leq E_e^{rampdown} \quad (26)$$

$$a_{e,t-1} - a_{e,t} \leq E_e^{rampup} \quad (27)$$

$$\phi_t = \phi_{t-1} + \bar{h}_t - \underline{h}_t \quad (28)$$

Except for the above-mentioned general Eqs. (25)–(27), natural gas boilers have an additional set of constraints in the model. They have three different states, *on* state when it is in operation and two *off* states termed as *warm* and *cold* and defined by (29). When the boiler shuts down it transitions from *on* state to *warm* state from which it requires less energy for a start-up. This transition is modelled by constraint (30). When the cooldown time has passed and the boiler did not start again, it must transition to *cold* state (31), meaning it will require more primary energy to start up again. Eqs. (32) and (33) ensure that the impossible transitions between states cannot happen, e.g., from *cold* to *warm* state. When the boiler is starting, it requires additional energy input depending if it is in *warm* or *cold* state. Constraints (34) and (35) set binary variables $v_{b,t}$ and $\kappa_{b,t}$ to 1 if the boiler has started from *cold* or *warm* state, respectively. With (36)–(38), starting binary variables are hard constrained so they can only be 1 in case of (34) and (35). Total natural gas consumed by the boiler in each hour is calculated using (39), considering operation and start-up consumption.

$$\epsilon_{b,t} + \zeta_{b,t} + \theta_{b,t} = 1 \quad (29)$$

$$\zeta_{b,t} \geq \epsilon_{b,t-1} - \epsilon_{b,t} + \zeta_{b,t-1} - \theta_{b,t} \quad (30)$$

$$\theta_{b,t} \geq \sum_{k=t-B_b^{cdt}}^t (\zeta_{b,k} + \theta_{b,k}) - B_b^{cdt} - \epsilon_{b,t} + 1 \quad (31)$$

$$\zeta_{b,t} + \theta_{b,t-1} \leq 1 \quad (32)$$

$$\theta_{b,t} + \epsilon_{b,t-1} \leq 1 \quad (33)$$

$$\theta_{b,t-1} - \theta_{b,t} \leq v_{b,t} \quad (34)$$

$$\zeta_{b,t-1} - \zeta_{b,t} - \theta_{b,t} \leq \kappa_{b,t} \quad (35)$$

$$\epsilon_{b,t-1} + \kappa_{b,t} + v_{b,t} \leq 1 \quad (36)$$

$$\theta_{b,t} + \zeta_{b,t} + \kappa_{b,t} \leq 1 \quad (37)$$

$$\theta_{b,t} + \zeta_{b,t} + v_{b,t} \leq 1 \quad (38)$$

$$\chi_{b,t} = o_{b,t} \cdot B_b^k + \epsilon_{b,t} \cdot B_b^l + v_{b,t} \cdot B_b^{cs} + \kappa_{b,t} \cdot B_b^{us} \quad (39)$$

The last group of equations connects all of the above mentioned processes and devices. They are basically enforcing the law of energy conservation. Consumed energy must be equal to produced and/or bought from the market. The first Eq. (40) is summing electricity consumption/production of all consumers (processes and electrolyser) and producers (PV and fuel cell) while selling surplus or buying deficit from the market. The next constraint (41) balances hydrogen, which can be produced with electrolyser, stored or consumed in processes, fuel cell or hydrogen boiler. The last balance Eq. (42) is for the heating energy which is produced by boilers or the fuel cell and consumed in processes. From these equations we can see how various energy vectors are intertwined and interact with each other; e.g., fuel cell which can be found in all three equations.

$$\pi_t = \sum_{k=1}^E \frac{a_{k,t}}{\eta_k^E} + \sum_{k=1}^P \beta_{k,t} - \sum_{k=1}^G d_{k,t} \cdot \eta_k^{G,el} - PV_t \quad (40)$$

$$\sum_{k=1}^P \gamma_{p,t} = \sum_{k=1}^E a_{k,t} - \sum_{k=1}^G d_{k,t} - \bar{h}_t + \underline{h}_t - \sum_{k=1}^H \frac{v_{k,t}}{\eta_k^H} \quad (41)$$

$$\sum_{k=1}^P \delta_{k,t} = \sum_{k=1}^B o_{k,t} + \sum_{k=1}^G d_{k,t} \cdot \eta_k^{G,h} + \sum_{k=1}^H a_{k,t} \quad (42)$$

The objective function is the cost minimisation of the operation; in this case, it is equal to electricity and natural gas bought from the

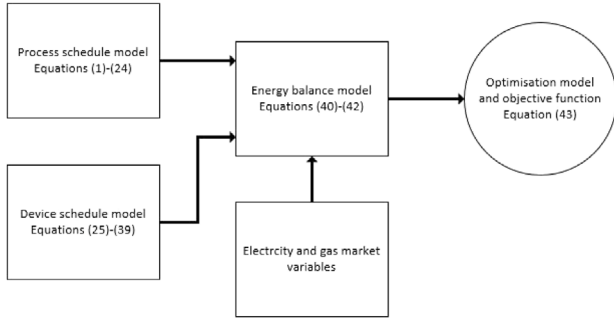

Fig. 2. Flowchart of the presented model.

market, as shown in (43). Fig. 2 summarises the logic and the assigned modelling equations of the presented model and its various segments.

$$\sum_{k=1}^T \pi_k \cdot C_k^{el} + \chi_b \cdot t \cdot C^{gas} \quad (43)$$

3. Case study

3.1. Scenarios

Five different scenarios will be considered throughout the analysis. All scenarios will have the same amount of PV for a fair comparison. The same is valid for the capacity of the electrolyser, which is dimensioned to satisfy at minimum hydrogen consumption in the facility processes. They are as follows:

- Initial scenario (S0) - Classic layout utilising natural gas boiler.
- First scenario (S1) - Hydrogen layout with electrolyser, hydrogen storage and fuel cell.
- Second scenario (S2) - Hydrogen layout with electrolyser, hydrogen storage, hydrogen boiler and fuel cell with higher electrical and lower heating efficiency.
- Third scenario (S3) - Hydrogen layout similar to S1 with higher efficiency electrolyser, hydrogen storage and fuel cell
- Fourth scenario (S4) - Hydrogen layout similar to S2 with higher efficiency electrolyser, hydrogen storage, hydrogen boiler and fuel cell with higher electrical and lower heating efficiency

The initial scenario can be considered a classic layout found in industrial plants. Scenarios S1 to S4 incorporate hydrogen technologies in order to lower the emissions of the plants. S1 and S3 have similar layouts where the fuel cell is used for electricity and heat production, while S2 and S4 have a combination of the fuel cell and a hydrogen boiler. The efficiencies of the fuel cell varies such that in S1 and S3, its dimension is defined by the heat production, while in S2 and S4, its dimension is defined by the electricity production.

Across these four scenarios, we will also consider two different electrolyser types. The first one (in S1 and S2) represents an older type that was already part of the industrial plant, while the second one (S3 and S4) represents a new technology. Layout and interaction between energy vectors and consumption sectors is shown in Figs. 3 and 4, where electricity vector is marked in blue, gas vector in yellow, heat vector in orange and hydrogen vector in grey. It is noted next to the names of various elements in which scenarios are used. When no scenario is mentioned, means that they appear in all observed scenarios. Consumption sectors represent demand from processes that will be explained in the next subsection.

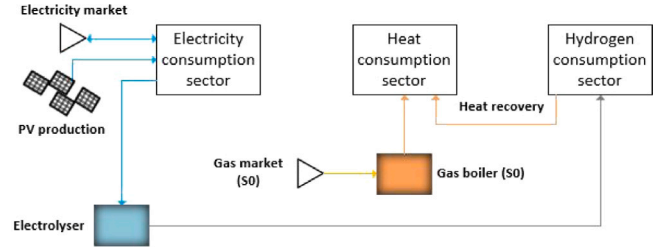

Fig. 3. Device layout of the industrial plant for S0.

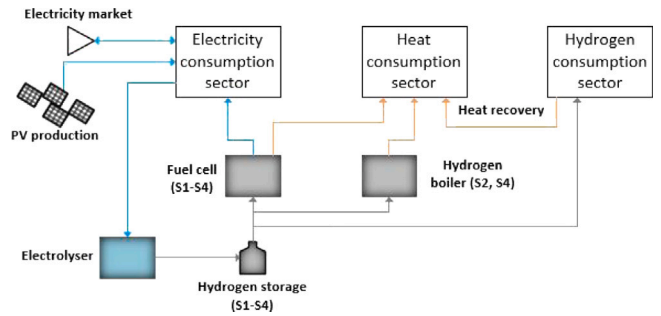

Fig. 4. Device layout of the industrial plant for S1-S4.

Table 1
Process electricity and heat consumption.

Process number	1	2	3	4	5
Electric consumption (MWh/t)	0.4	0.55	0.9	0.8	0.6
Heat consumption (MWh/t)	0.7	0.5	0.3	0	0.5

3.2. Input parameters

The layout of the processes in the industrial facility is shown in Fig. 5. It is composed of five processes, set in sequential order. One raw material, four intermediate materials and one final material can be identified in the figure. Raw material has to pass through all five processes to become the final product, denoted with arrows. The length of each process is shown in the brackets next to the process sequence number. Processes 2 and 5 are classified as continuous while the rest are defined as batch. Process 4 is the only one with hydrogen consumption and heat recovery system consuming 1 MWh of hydrogen per ton of material processed with heat recovery of 0.2 MWh/t. All other processes have electrical and heat consumption dependent on the materials processed, as shown in Table 1. The amount of input and output materials for each process are limited to 5 tonnes. There is a sufficient amount of raw materials to produce the required volume of the final product. All intermediate materials start at 0 capacity at the beginning. The optimisation is run for three days (72 h) with a step of one hour. This setup is chosen to suit the resolution used in European day-ahead spot markets, capturing all the relevant processes for the industrial facility but still being computationally feasible. Total amount of the required final product is 60 tonnes, while there is an additional requirement that 20 tonnes are produced each day (at the end of each 24-hour period). To produce one ton of the final material, 3.25 MWh of electricity, 1.55 MWh of heat and 1 MWh of hydrogen are needed while recovering 0.2 MWh of heat.

All scenarios contain a PV system whose curve is generated using [41,42] and is shown in Fig. 6. The initial scenario (S0) contains a boiler sized so it can produce enough heat needed at any time, with rated power of 50 MW. The parameters of its efficiency curve are 1.12 for the slope and 1 for the y-intercept. All the other heat-producing



Fig. 5. Process layout of the industrial plant.

equipment (mainly fuel cells and hydrogen boilers) are also sized so they have roughly the same heat production as a natural gas boiler. The output power of the electrolyser is 25 MWh with the efficiency of 66% [43], used in S1 and S2. Since there have been reports of a higher efficiency electrolyser technologies, we decided to incorporate the one with the efficiency of 80% [44] into our analyses in S3 and S4. Hydrogen storage is the same for all scenarios and can store up to 300 MWh of hydrogen with the maximum input and output power of 300 MW if needed. Two different fuel cells are used, both with an input power of 100 MW. The first one has electric efficiency of 37% and heating efficiency of 52%, used in S1 and S3. This fuel cell is chosen due to a better fit with the heat consumption of the industrial facility. The second fuel cell has a higher electric efficiency of 47% and lower heat efficiency of 36% (used in S2 and S4) and is constructed to work in conjunction with the hydrogen boiler [45]. The last hydrogen device is a boiler with an output power of 50 MW and efficiency of 85%, used in S2 and S4. Although hydrogen boilers that use only hydrogen are not yet commercially available they are considered to get a comprehensive insight into all future options. Device sizes were chosen iteratively so they can cover required consumption by the industrial processes in all time steps, without making them oversized. We do not claim these sizes are optimal, but that they are sufficient for purposes of the industrial plant. Natural gas prices are taken from [46] and electricity prices from Croatian power market [47]. Both prices are taken from late 2021 (before the rapid increase in prices in 2021 in Europe). Natural gas price is equal to 90 €/MWh and electricity price can be seen in Fig. 7. The case studies for sensitivity analyses are created by taking two base prices and multiplying them with a selected factor. This means the natural gas price multiplier goes from 0.5 to 3 with a step of 0.5 (6 prices in total), while the electricity price multiplier goes from 0.5 to 2 with a step of 0.5 (4 prices in total). When combined, there are 24 cases in total. Historically, electricity and natural gas prices had a certain correlation between them, but are lately becoming more decoupled from one another especially in the European Union [48,49]. The above-described price scenarios are not designed to reflect fully realistic scenarios, but to capture past and future trends and ratios of natural gas and electricity prices. Lastly, the specific CO₂ emission intensity for electricity bought from the electricity market is 133 kg/MWh [50] and for natural gas is 386 kg/MWh [51]. Nitrogen oxide (NO_x) and carbon monoxide (CO) are produced locally by burning natural gas with specific emissions being 0.2 kg/MWh for NO_x and 0.04 kg/MWh for CO. Please note that model is created in a way that parameters and layout of processes are easily changed and adjusted for different industrial plants and are not limited to ones presented in our case study. Parameters for devices used to cover consumption can be easily changed and they can be removed or added when needed. The model also leaves room for the implementation of various features, devices, etc., considering that they can be modelled appropriately.

4. Discussion on the reduction of GHG emissions

In this Subsection we will analyse the impact of hydrogen decarbonisation of the industrial facility on energy exchange with a grid and on greenhouse gas emissions (CO₂, NO_x and CO). Due to brevity we will focus only on scenarios S0 and S1 (as representatives of traditional natural gas and modern decarbonised layouts), with two different capacities of installed PV and with two different electricity trading policies. We choose to showcase GHG emission analysis only for S1, as we believe it to be sufficient to show all effects of it and keep analysis efficient and well organised. Also, we chose exactly S1

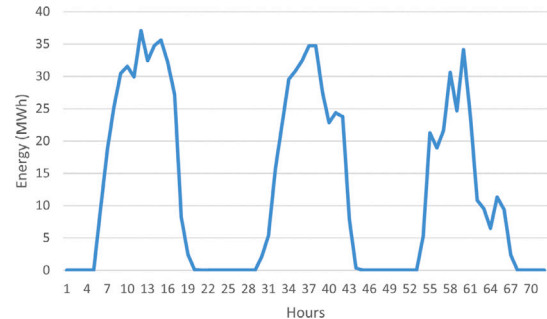

Fig. 6. Photovoltaic production.

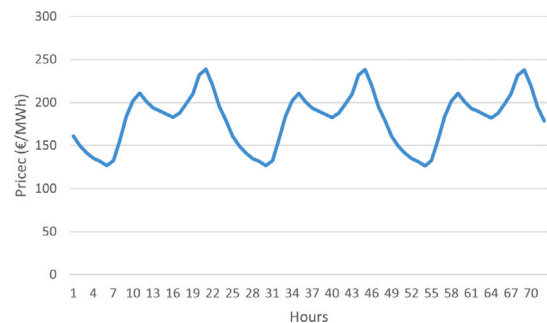

Fig. 7. Base electricity prices.

as it was the worst option out of four observed scenarios, as will be shown in economic analysis. Two different PV capacities are: (i) higher PV capacity with the production curve shown on Fig. 6 and (ii) lower PV capacity which is 50% of PV capacity in (i). Two different trading policies refer to: (i) trading on the electricity market as explained in Section 3 and (ii) the same strategy as in (i) with the penalisation of the sold electricity aiming at maximisation of local consumption. Penalisation of energy injected back to the grid effectively raises self sufficiency of the system and lowers emissions accordingly. Above mentioned scenarios are not necessarily economically optimal but are created to showcase possibilities of hydrogen as an energy vector and to be in line with the recent trends in different countries where many end-users, including industry facilities, are looking into becoming more grid independent and sustainable regardless the cost optimality criteria. The total calculated CO₂ emissions are the result of two specific processes. The first one is caused by burning natural gas in the boiler and emitted from the industrial plant. The second one is the indirect one and is a result of purchasing electricity from the market (which is dependant on the energy mix). The NO_x and CO emissions are only produced by burning natural gas.

Tables 2 and 3 show the results for total import/export of electricity and natural gas and total CO₂ emissions for all cases. A general observation from both tables, as expected, is that S0 scenario creates higher emissions than S1. S1 scenario has significantly lower CO₂ emissions primarily as it does not rely on the natural gas for heat production as it can use hydrogen as an alternative and produce zero NO_x and CO emissions. As a result there is an increase in S1 electricity import, used for the consumption of the electrolyser to produce hydrogen. Since the specific CO₂ emissions of electricity are lower than that of natural gas, even when taking into account the efficiencies of boiler and

Table 2
Results comparison without penalised export.

Scenario	PV	Electricity import (MWh)	Electricity export (MWh)	Natural gas import (MWh)	Total CO ₂ emissions (kg)
S0	Lower	299.16	138.55	283.08	149057.2
S1	Lower	764.28	180.84	0	101649.2
S0	Higher	209.12	498.72	280.84	136217.4
S1	Higher	636.8	503.57	0	84693.8

Table 3
Results comparison with penalised export.

Scenario	PV	Electricity import (MWh)	Electricity export (MWh)	Natural gas import (MWh)	Total CO ₂ emissions (kg)
S0	Lower	197.91	37.3	485.91	137489.6
S1	Lower	583.44	0	0	77596.9
S0	Higher	89.75	379.35	374.39	121808.4
S1	Higher	133.23	0	0	17719.23

Table 4
NO_x and CO emissions.

	No penalised export		Penalised export	
	Lower	Higher	Lower	Higher
NO _x (kg)	56.62	56.17	97.18	74.99
CO (kg)	11.32	11.23	19.44	14.99

electrolyser, total emissions are lowered in S1 as oppose to S0 across all cases; as shown in Tables 2 and 3.

In the case of higher capacity of local PV, both S0 and S1 have lower overall emissions compared to lower PV capacity as they sell the surplus of locally produced electricity and therefore offset the emission from imported electricity. In the first analysis, ((Table 2) CO₂ emissions reduction is 31% and 37% for lower and higher PV, respectively, while for the second analysis (Table 3) is 43% and 85%.

However, when comparing counterpart scenarios between these two analysis, lower emissions are found in Table 3. In the analysis where exporting electricity is penalised, the results suggest higher local utilisation of PV as selling excess electricity is a less profitable option. In S1 scenario all electricity produced from the PV can be utilised locally as there is sufficient flexibility in form of consumption, electrolyser and fuel cell scheduling; this is shown with the export of electricity equal to “0”. On the other hand, S0 is not able to fully utilise locally produced PV electricity as there is a lack of flexibility due to usage of natural gas boiler as producer of heat.

The importance of local emission reduction is that its impact is much higher on the industry facility workers and their health as well as local population living in the proximity of the industry facility [52]. Considering only expected CO₂ emissions reduction, hundred millions fewer premature deaths worldwide could be mitigated as reported in [53]. Table 4 shows NO_x and CO emissions for S0. These emissions are only effected with natural gas consumption, meaning they are higher in a case with penalised export when the natural gas import is higher. These emissions are shorter range emission particles, with a range of up to 200 km. NO_x and CO emissions are fully mitigated when we replaced the locally burned fossil fuels with hydrogen.

From the emission reduction point, hydrogen technologies displace emission production to electricity producers. This entails that the exact emissions the industrial plant is responsible for are not exactly known at any given time, therefore average emissions are usually used. These specific emissions are highly dependent on the energy mix and will deeply vary from country to country. However, with current trends of increase in renewable energy sources and shutdown of high-emission power plants, specific emissions will surely drop in the future. This entails that the proposed industrial plant will have lower total emissions.

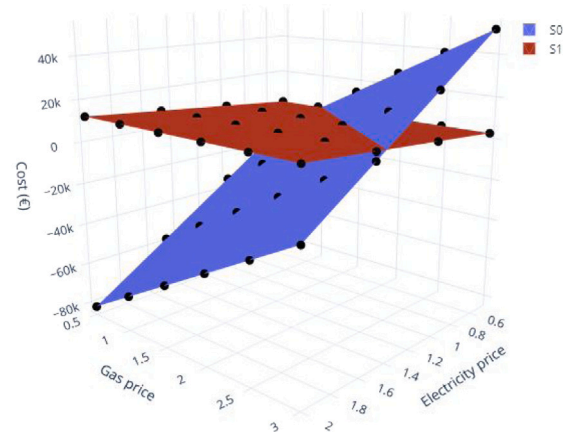

Fig. 8. Sensitivity analysis comparison of S0 and S1.

5. Economic aspects of decarbonised industry facility

As a baseline for all conducted sensitivity analyses, we consider the standard natural gas layout, or business-as-usual industry facility layout, defined as S0. The sensitivity analyses of different electricity and natural gas price ratios conducted in this subsection focusing on two main aspects for four hydrogen scenarios (S1–S4):

- are compared to the scenario S0 in order to validate economic feasibility of hydrogen technology in the observed industry facility.
- are compared to each other to understand how different technical characteristics of hydrogen equipment and their configuration impact the capability and flexibility of the industry facility to adopt to market price changes and disturbances.

5.1. Cost comparison: S0 vs S1–S4

In the transition to zero carbon energy system, green hydrogen is recognised as a pillar enabling this, especially with the energy intensive industry. However, the costs of the technology do not yet justify the investments. Here we focus on the operational aspects and discuss and analyse under which market conditions and prices does the replacement of the natural gas equipment with hydrogen becomes viable. To conclude, we conducted a sensitivity analysis comparing each defined hydrogen scenario (S1–S4) with the baseline natural gas scenario (S0). The optimisation for all scenarios (S0–S4) is conducted for 3 representative days and a range of natural gas and electricity prices. In total, 24 gas–electricity price cases are observed with different multipliers modifying the base price curve, as shown in Section 3.2. Used natural gas and electricity prices and their ratios are designed with the aim to define the points where the operational cost curves of S0 and S1–S4 intersect. These intersections define operating cost price parity between natural gas and hydrogen technology and can be seen as feasible points for hydrogen investments.

The results of 24 simulated cases, comparing S0 and S1, are shown in Fig. 8. Indicating that S1 has better results in 6 of natural gas–electricity price cases (25%), mostly when the natural gas price is very high (average price between 180–270 €/MWh) and electricity price is very low (average price of 90 and 180 €/MWh). Similar natural gas–electricity price logic and comparison of S0 with S2 is shown on Fig. 9 where S2 shows better results in 9 out of 24 cases (37.5%) and very similar results in two natural gas–electricity price cases. Fig. 10 is comparison with S3, where 12 out of 24 natural gas–electricity price cases are better (50%), with one case having similar cost. An interesting observation can be made here on the difference in the slope of the

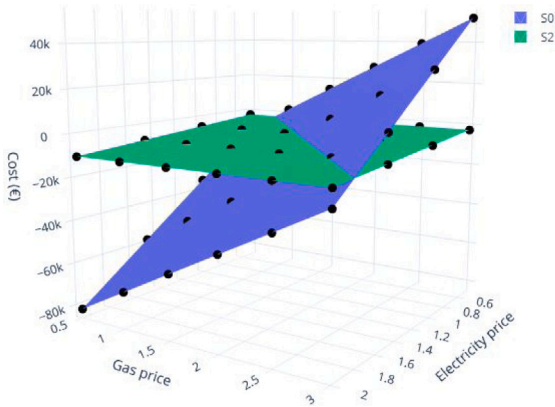

Fig. 9. Sensitivity analysis comparison of S0 and S2.

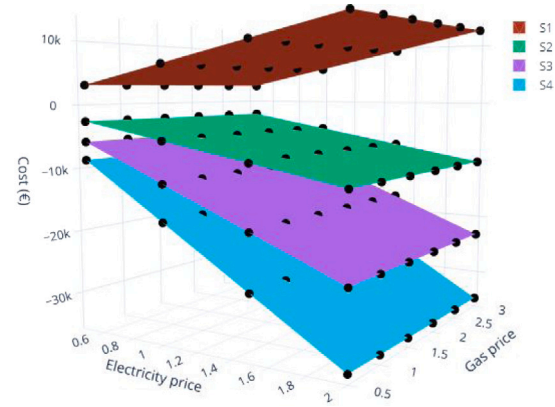

Fig. 12. Sensitivity analysis comparison of S1–4.

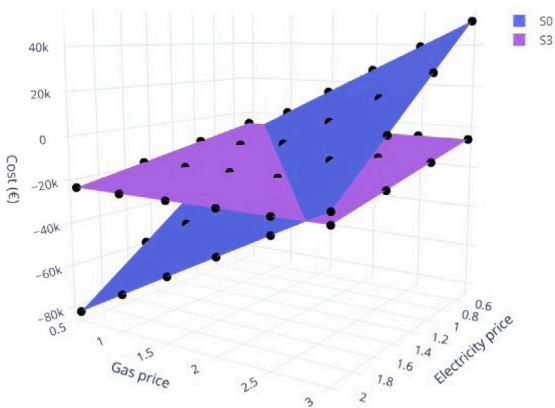

Fig. 10. Sensitivity analysis comparison of S0 and S3.

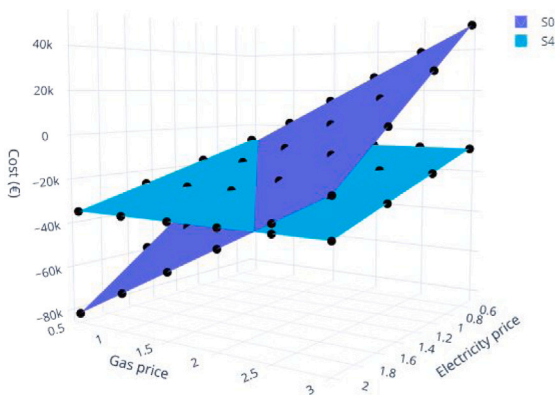

Fig. 11. Sensitivity analysis comparison of S0 and S4.

surface, where S0 has a much steeper slope, meaning that in S0 the industry facility is at much higher risk with regards to market prices than S3. Finally, in Fig. 11 a comparison is made between S4 and S0. S4 outperforms S0 in 14 out of 24 natural gas–electricity price cases (58%) and has very similar values in two other natural gas–electricity price cases. Same argumentation as with S3 can be used here, in terms of market price exposure.

5.2. Cost comparison: among S1–S4

In this analysis, we will compare all hydrogen scenarios (S1–S4) to each other to check how the hydrogen equipment configuration impacts

the overall industry facility exposure to changing energy prices. The results are visualised for all scenarios and prices as operational costs in Fig. 12. For easier understanding, one should keep in mind that the equipment layout in scenarios S1 and S3 and scenarios S2 and S4 is the same, as described in Section 3, with different efficiencies of the selected equipment. It also needs to be noted that the industry facility operation is heat driven, meaning that electricity from the fuel cell is treated as a byproduct and not correlated with local electricity demand.

Fig. 12 shows that higher efficiency electrolyser scenarios, S3 and S4, are characterised with the reduction of operational costs as prices of natural gas and electricity increase, exploiting the benefits of selling excess electricity at high electricity market prices (lower losses and higher flexibility). In opposite, since in S1 scenario there is no excess electricity produced, this scenario observes higher operational costs with the increase in natural gas and electricity prices. Interestingly, the S2 scenarios is least affected by the change in prices meaning the dimensioning of the units and heat and electricity ratio in that layout is most resilient to the price disturbances in the market.

The operational cost differences are very low between the four scenarios (S1–4) in case of overall low electricity and natural gas prices (average is 90 €/MWh for electricity and 45 €/MWh for natural gas). However, the differences increase to 45,000 euros between S1 and S4 for three-day optimisation in cases of higher electricity and natural gas prices (average is 360 €/MWh for electricity and 270 €/MWh for natural gas). Most of the differences between scenarios can be explained by efficiencies in heat production which directly affect the import of electricity. Heat is produced from hydrogen in either a fuel cell or a boiler. The fuel cell has lower heat production efficiency than the boiler, but additionally produces electricity. In S1 and S3 the fuel cell is the only way of producing heat, meaning electricity is produced as a side effect of heat production and is not always sold at the optimal market price. Fig. 13 shows the average power schedule of the fuel cells and the boilers in all scenarios for one set of prices (average electricity price of 180 €/MWh). In S2 and S4, there is a possibility of using multiple devices which leads to the decoupling of heat and electricity production making them independent from one another. It clearly shows that heat production from hydrogen boilers is price optimal option over fuel cells when combined in the selected scenarios (S2 and S4). This conclusion is stemming from the fact that the area beneath fuel cell curves is much lower than boiler curves. The needs for heat production from these devices are greater than electricity needs. According to results of optimisation the boiler is a better alternative, because of higher heating efficiency. Also, there might be an abundance of electricity sources to draw from to satisfy consumption while it is not beneficial to sell it. This also goes to show that electricity production

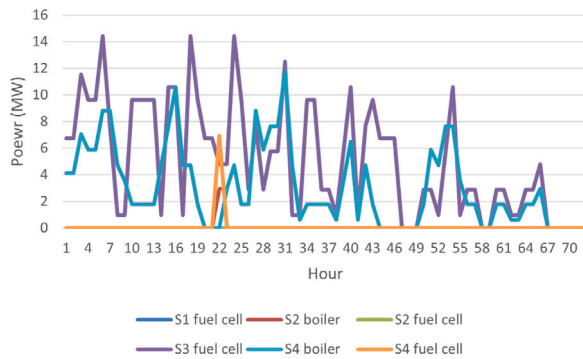

Fig. 13. Fuel cell and boiler average power schedule in S1, S2, S3 and S4.

from fuel cells is not that effective in terms of levelling the marginal cost of low-efficiency heat production.

5.3. Discussion on the economic analysis

It was shown in the results Section 5.1 how hydrogen industrial systems compare with classical natural gas based industrial systems from the economic perspective. Analysis concluded that hydrogen technologies can rival classically inexpensive natural gas technologies in industrial application under specific natural gas–electricity price couples. It was also shown that with newer technologies (e.g. more efficient or new technology of electrolyser and hydrogen boiler) overall cost shifts significantly in the favour of hydrogen. Comparison between different hydrogen scenarios (S1–S4) showcased possibilities of different technologies and layouts. In conclusion, S1 did not have the means to adapt to rising prices while S2, S3 and S4 managed to perform better with higher flexibility for electricity import and export. Higher efficiency of hydrogen technologies and their commercial availability would further decrease the operational costs. However, with already existing technologies and their efficiencies, adequate dimensioning and electricity-to-heat ratios can make an industry facility resilient to market price changes. Decoupling of electricity and heat production through usage of boiler was proven as a better option than concurrent production from fuel cell. Results presented in the paper should be taken somewhat conservatively. Some of the analysed scenarios are made assuming future hydrogen technologies' development as well as their future performance. Although these assumptions are backed up by the literature, it is uncertain how these technologies will develop in reality. Future price trends are impossible to predict; the price of gas and electricity might stagnate at current levels or return to former values. For these reasons the values in the analyses should not be considered as estimates or predictions, but rather as sensitivity analyses covering various future alternatives. There are also future possibilities for participation in different energy spot markets, for example on ancillary services, balancing or intraday markets, where internal flexibility can be further exploited for profit. This would, even more, built the case for the transition to hydrogen due to its flexibility potential, however, such analyses are out of the scope of this paper and part of future work. Another limitation of the paper is omitting the uncertain nature of PV production. Including PV uncertainty would make an impact on the results but could also push hydrogen layout scenarios to even higher profitability, once again, due to the additional flexibility they can provide. Hydrogen layouts would have an easier time compensating for the intermittent nature of PV production to reduce charges for the imbalance such production might create. Further flexibility provision is something that we plan to investigate in our future work.

6. Conclusion

The paper proposes an optimisation model and brings systematic analysis of decarbonisation strategy for multi-energy intensive industrial consumers replacing natural gas with emerging hydrogen technologies. Various different hydrogen layouts are presented and compared to traditional natural gas based layout. They consist of electrolysers with different efficiencies, hydrogen storage and a combination of fuel cell and hydrogen boiler for heat production. The models of different industry facility setups are cast as mixed integer linear optimisation model considering price responsive demand response process scheduling and energy device scheduling to satisfy consumption needs. Sensitivity analysis is conducted on the basis of different prices of electricity and natural gas comparing total costs of industrial plants with different layouts. The main findings are the following:

1. For lower electricity prices (average of 90 and 180 €/MWh) and higher natural gas prices (180 to 270 €/MWh), hydrogen layout brings lower costs in all cases compared to natural gas layout,
2. Newer hydrogen technology with higher efficiency and with fuel cells designed for higher electricity production reaches lower costs when compared with natural gas technology in 58% of the observed cases,
3. Combination of local renewables and flexibility from hydrogen technologies makes the industrial facility more resilient to energy price increases, seen as a less steep slope on sensitivity analysis figures,
4. Integration of hydrogen technologies significantly decreases total CO₂ emissions of the industrial facility are between 30% and 85% (depending on electricity trading policy and size of PV), as well as it completely removes all local greenhouse gas emissions (CO₂, NO_x and CO),
5. Hydrogen technology flexibility can increase the level of self-supply as it can bridge the difference between local consumption and production as well as help with the integration of renewable energy sources.

CRedit authorship contribution statement

Matija Kostelac: Writing – review & editing, Writing – original draft, Visualization, Validation, Software, Resources, Methodology, Investigation, Formal analysis, Data curation, Conceptualization. **Ivan Pavić:** Writing – review & editing, Validation, Supervision, Resources, Methodology, Formal analysis, Conceptualization. **Tomislav Capuder:** Writing – review & editing, Validation, Supervision, Resources, Project administration, Methodology, Funding acquisition, Formal analysis, Conceptualization.

Declaration of competing interest

The authors declare that they have no known competing financial interests or personal relationships that could have appeared to influence the work reported in this paper.

Data availability

Data will be made available on request.

Acknowledgements

This work was funded by the European Union through the European Regional Development Fund for the Competitiveness and Cohesion Operational Programme 2014–2020 of the Republic of Croatia under project No. KK.01.1.1.07: “Universal Communication and Control System for Industrial Facilities”.

The work of Ivan Pavić was funded in part by the Luxembourg National Research Fund (FNR) and PayPal, PEARL grant reference 13342933/Gilbert Fridgen as well as by the Luxembourg National Research Fund (FNR) – FlexBeAM Project, ref. 17742284

References

- [1] European Commission. EU energy in figures - publications office of the EU. 2020.
- [2] European Parliament. Fit for 55 - The EU's plan for a green transition - Consilium.
- [3] Abdin Zainul, Zafaranloo Ali, Rafiee Ahmad, Mérida Walter, Lipiński Wojciech, Khalilpour Kaveh R. Hydrogen as an energy vector. *Renew Sustain Energy Rev* 2020;120:109620.
- [4] Longden Thomas, Beck Fiona J, Jotzo Frank, Andrews Richard, Prasad Mousami. 'Clean' hydrogen? – Comparing the emissions and costs of fossil fuel versus renewable electricity based hydrogen. *Appl Energy* 2022;306:118145.
- [5] Brinkmann Thomas, Giner Santonja Germán, Schorcht Frauke, Roudier Serge, Delgado Sancho Luis. Best available techniques reference document for the production of Chlor-alkali. 2014.
- [6] Schorcht Frauke, Kourti Ioanna, Scalet Bianca Maria, Roudier Serge, Sancho Luis Delgado. Best available techniques (BAT) reference document for the production of cement, lime and magnesium oxide. In: European commission. 2013, p. 2013.
- [7] Olabi AG, Abdelkareem Mohammad Ali. Renewable energy and climate change. *Renew Sustain Energy Rev* 2022;158:112111.
- [8] Kafetzis A, Ziogou C, Panopoulos KD, Papadopoulou S, Seferlis P, Voutetakis S. Energy management strategies based on hybrid automata for islanded microgrids with renewable sources, batteries and hydrogen. *Renew Sustain Energy Rev* 2020;134:110118.
- [9] Heffron Raphael, Körner Marc-Fabian, Wagner Jonathan, Weibelzahl Martin, Fridgen Gilbert. Industrial demand-side flexibility: A key element of a just energy transition and industrial development. *Appl Energy* 2020;269:115026.
- [10] Smitkova Miroslava Farkas, Janicek Frantisek, Martins Florinda. Hydrogen economy : Brief summarization of hydrogen economy. In: 2022 International conference on electrical, computer and energy technologies. 2022, p. 1–5.
- [11] huan Zhang Yang, chao Jia Zhi, ming Yuan Ze, Yang Tai, Qi Yan, liang Zhao Dong. Development and application of hydrogen storage. *J Iron Steel Res, Int* 2015;22(9):757–70.
- [12] Zhao Danwen, Li Ziyue. Feasibility investigation of hydrogen generation & storage. In: 2021 3rd international academic exchange conference on science and technology innovation. 2021, p. 1898–905.
- [13] Zhu Yutong. From hydrogen production to storage: A process for sustainable development of underground hydrogen storage in caverns. In: 2021 3rd International academic exchange conference on science and technology innovation. 2021, p. 1658–63.
- [14] Lagioia Giovanni, Spinelli Maria Pia, Amicarelli Vera. Blue and green hydrogen energy to meet European Union decarbonisation objectives. An overview of perspectives and the current state of affairs. *Int J Hydrogen Energy* 2023;48(4):1304–22.
- [15] Eicke Laima, De Blasio Nicola. Green hydrogen value chains in the industrial sector—Geopolitical and market implications. *Energy Res Soc Sci* 2022;93:102847.
- [16] Lebrouhi BE, Djoupo JJ, Lamrani B, Benabdelaziz K, Kouksou T. Global hydrogen development - A technological and geopolitical overview. *Int J Hydrogen Energy* 2022;47(11):7016–48.
- [17] Amin Muhammad, Shah Hamad Hussain, Fareed Anaiz Gul, Khan Wasim Ullah, Chung Eunhyea, Zia Adeel, et al. Hydrogen production through renewable and non-renewable energy processes and their impact on climate change. *Int J Hydrogen Energy* 2022;47(77):33112–34.
- [18] Li Bei. Build 100% renewable energy based power station and microgrid clusters through hydrogen-centric storage systems. In: 2020 4th International conference on HVDC. 2020, p. 1253–7.
- [19] Pan Guangsheng, Gu Wei, Lu Yuping, Qiu Haifeng, Lu Shuai, Yao Shuai. Optimal planning for electricity-hydrogen integrated energy system considering power to hydrogen and heat and seasonal storage. *IEEE Trans Sustain Energy* 2020;11(4):2662–76.
- [20] Miljan Petra, Tomic Zeljko, Pandzic Hrvoje. Optimal bidding for a large battery-electrolyzer facility in the day-ahead market. In: 2022 IEEE 21st mediterranean electrotechnical conference. IEEE; 2022, p. 201–6.
- [21] Samsatli Sheila, Samsatli Nouri J. The role of renewable hydrogen and inter-seasonal storage in decarbonising heat – Comprehensive optimisation of future renewable energy value chains. *Appl Energy* 2019;233–234:854–93.
- [22] Danieli Piero, Lazzaretto Andrea, Al-Zaili Jafar, Sayma Abdulnaser, Masi Massimo, Carraro Gianluca. The potential of the natural gas grid to accommodate hydrogen as an energy vector in transition towards a fully renewable energy system. *Appl Energy* 2022;313:118843.
- [23] Pavić Ivan, Čović Nikolina, Pandžić Hrvoje. PV-battery-hydrogen plant: Cutting green hydrogen costs through multi-market positioning. *Appl Energy* 2022;328:120103.
- [24] Carreiro Andreia M, Jorge Humberto M, Antunes Carlos Henggeler. Energy management systems aggregators: A literature survey. *Renew Sustain Energy Rev* 2017;73:1160–72.
- [25] D'Ettorre F, Banaei M, Ebrahimi R, Pourmousavi S Ali, Blomgren EMV, Kowalski J, et al. Exploiting demand-side flexibility: State-of-the-art, open issues and social perspective. *Renew Sustain Energy Rev* 2022;165:112605.
- [26] Golmohamadi Hessam. Demand-side management in industrial sector: A review of heavy industries. *Renew Sustain Energy Rev* 2022;156:111963.
- [27] Ramin D, Spinelli S, Brusaferrri A. Demand-side management via optimal production scheduling in power-intensive industries: The case of metal casting process. *Appl Energy* 2018;225:622–36.
- [28] Helin Kristo, Käksi Anssi, Zakeri Behnam, Lahdelma Risto, Syri Sanna. Economic potential of industrial demand side management in pulp and paper industry. *Energy* 2017;141:1681–94.
- [29] Wang Xiaonan, El-Farra Nael H, Palazoglu Ahmet. Optimal scheduling of demand responsive industrial production with hybrid renewable energy systems. *Renew Energy* 2017;100:53–64, Special Issue: Control and Optimization of Renewable Energy Systems.
- [30] Shoreh Maryam H, Siano Pierluigi, Shafie-khah Miadreza, Loia Vincenzo, Catalão João PS. A survey of industrial applications of demand response. *Electr Power Syst Res* 2016;141:31–49.
- [31] Gholian A, Mohsenian-Rad H, Hua Y. Optimal industrial load control in smart grid. *IEEE Trans Smart Grid* 2016;7(5):2305–16.
- [32] Gholian A, Mohsenian-Rad H, Hua Yingbo, Qin Joe. Optimal industrial load control in smart grid: A case study for oil refineries. In: 2013 IEEE power energy society general meeting. 2013, p. 1–5.
- [33] Shahabuddin M, Brooks Geoffrey, Rhamdhani Muhammad Akbar. Decarbonisation and hydrogen integration of steel industries: Recent development, challenges and technoeconomic analysis. *J Clean Prod* 2023;395:136391.
- [34] Bhaskar Abhinav, Assadi Mohsen, Somehsaraei Homam Nikpey. Can methane pyrolysis based hydrogen production lead to the decarbonisation of iron and steel industry? *Energy Convers Manag* X 2021;10:100079.
- [35] chao Fan Xiao, qing Wang Wei, jing Shi Rui, jiang Cheng Zhi. Hybrid pluripotent coupling system with wind and photovoltaic-hydrogen energy storage and the coal chemical industry in Hami, Xinjiang. *Renew Sustain Energy Rev* 2017;72:950–60.
- [36] Liu Wenguo, Zuo Haibin, Wang Jingsong, Xue Qingguo, Ren Binglang, Yang Fan. The production and application of hydrogen in steel industry. *Int J Hydrogen Energy* 2021;46(17):10548–69.
- [37] Ostadi Mohammad, Paso Kristofer Gunnar, Rodriguez-Fabia Sandra, Øi Lars Erik, Manenti Flavio, Hillestad Magne. Process integration of green hydrogen: Decarbonization of chemical industries. *Energies* 2020;13(18).
- [38] Chang Yifan, Wan Fang, Yao Xilong, Wang Jianxin, Han Yunfei, Li Hui. Influence of hydrogen production on the CO2 emissions reduction of hydrogen metallurgy transformation in iron and steel industry. *Energy Rep* 2023;9:3057–71.
- [39] Gurobi Optimization, LLC. Gurobi optimizer reference manual. 2021.
- [40] Todd DeWayne, Caufield Michael, Helms Brian, Starke Michael R, Kirby Brendan J, Kueck John D. Providing reliability services through demand response: A preliminary evaluation of the demand response capabilities of Alcoa Inc. Technical report, 2009.
- [41] Pfenninger Stefan, Staffell Iain. Long-term patterns of European PV output using 30 years of validated hourly reanalysis and satellite data. *Energy* 2016;114:1251–65.
- [42] Pfenninger S, Staffell I. <https://www.renewables.ninja/>.
- [43] IRENA. Hydrogen from renewable power: Technology outlook for the energy transition. 2018.
- [44] Gallandat Noris, Romanowicz Krzysztof, Züttel Andreas. An analytical model for the electrolyser performance derived from materials parameters. *J Power Energy Eng* 2017;05(10):34–49.
- [45] Guaitolini Stefani Vanussi Melo, Yahyaoui Imene, Fardin Jussara Farias, Encarnação Lucas Frizera, Tadeo Fernando. A review of fuel cell and energy cogeneration technologies. In: 2018 9th International renewable energy congress. 2018, p. 1–6.
- [46] EU-28: industrial prices of natural gas 2019 | Statista, <https://www.statista.com/statistics/1047083/natural-gas-price-european-union-country/>.
- [47] Croatian energy exchange - croatian energy exchange Ltd. - croplex.hr.
- [48] Tackling rising energy prices: A toolbox for action and support.
- [49] REPowerEU: A plan to rapidly reduce dependence on Russian fossil fuels and fast forward the green transition.
- [50] Greenhouse gas emission intensity of electricity generation by country — European Environment Agency.
- [51] Penman J, Gytarsky Michael, Hiraishi T, Irving W, Krug T. 2006 IPCC - Guidelines for national greenhouse gas inventories. 2006.
- [52] Manisalidis Ioannis, Stavropoulou Elisavet, Stavropoulos Agathangelos, Bezirtzoglou Eugenia. Environmental and health impacts of air pollution: A review. *Front Public Health* 2020;8.
- [53] Shindell Drew, Faluvegi Greg, Seltzer Karl, Shindell Cary. Quantified, localized health benefits of accelerated carbon dioxide emissions reductions. *Nature Clim Change* 2018;8(4):291–5.

Article

Planning and Operational Aspects of Individual and Clustered Multi-Energy Microgrid Options

Matija Kostelac ^{*}, Lin Herenčić  and Tomislav Capuder 

Department of Energy and Power Systems, Faculty of Electrical Engineering and Computing, University of Zagreb, 10000 Zagreb, Croatia; lin.herenacic@fer.hr (L.H.); tomlav.capuder@fer.hr (T.C.)

* Correspondence: matija.kostelac@fer.hr

Abstract: With the restructuring of the power system, household-level end users are becoming more prominent participants by integrating renewable energy sources and smart devices and becoming flexible prosumers. The use of microgrids is a way of aggregating local end users into a single entity and catering for the consumption needs of shareholders. Various microgrid architectures are the result of the local energy community following different decarbonisation strategies and are frequently not optimised in terms of size, technology or other influential factors for energy systems. This paper discusses the operational and planning aspects of three different microgrid setups, looking at them as individual market participants within a local electricity market. This kind of implementation enables mutual trade between microgrids without additional charges, where they can provide flexibility and balance for one another. The developed models take into account multiple uncertainties arising from photovoltaic production, day-ahead electricity prices and electricity load. A total number of nine case studies and sensitivity analyses are presented, from daily operation to the annual planning perspective. The systematic study of different microgrid setups, operational principles/goals and cooperation mechanisms provides a clear understanding of operational and planning benefits: the electrification strategy of decarbonising microgrids outperforms gas and hydrogen technologies by a significant margin. The value of coupling different types of multi-energy microgrids, with the goal of joint market participation, was not proven to be better on a yearly level compared to the operation of same technology-type microgrids. Additional analyses focus on introducing distribution and transmission fees to an MG cooperation model and allow us to come to the conclusion of there being a minor impact on the overall operation.

Keywords: microgrids; decarbonisation; uncertainty; renewable energy sources; electricity market; energy vectors



Citation: Kostelac, M.; Herenčić, L.; Capuder, T. Planning and Operational Aspects of Individual and Clustered Multi-Energy Microgrid Options. *Energies* **2022**, *15*, 1317. <https://doi.org/10.3390/en15041317>

Academic Editors: Goran Knežević, Danijel Topić and Poul Alberg Østergaard

Received: 6 December 2021

Accepted: 7 February 2022

Published: 11 February 2022

Publisher's Note: MDPI stays neutral with regard to jurisdictional claims in published maps and institutional affiliations.



Copyright: © 2022 by the authors. Licensee MDPI, Basel, Switzerland. This article is an open access article distributed under the terms and conditions of the Creative Commons Attribution (CC BY) license (<https://creativecommons.org/licenses/by/4.0/>).

1. Introduction

Renewable energy sources (RES) are integrated closely with end users, i.e., in a distribution grid, they are key components in the energy transition and decarbonisation of the power system. The smart coordination of RES, along with the controllable assets of consumers, can unlock new flexibility options and transform passive end users into active market participants [1]. The effect can be further amplified by the integration of different multi-energy vectors, such as electricity, gas and hydrogen. The smart operation of multi-energy systems (MESs) implies the incorporation of different energy vectors that complement each other by shifting and storing energy in different forms [2]. Subject to a combination of energy sources and energy vectors, geographical specifics and supply-demand patterns, MESs can contribute to the integration of variable RES, cost minimisation, increased self-sufficiency, the decarbonisation of local energy systems and an increased potential for providing system services [3]. There is a wide variety of MES flexibility options, including: demand response (DR); energy storage systems, such as batteries (BESSs) and heat storage; and energy conversion devices, such as combined heat and power units

(CHP), heat pumps (HP) and power-to-hydrogen systems (P2H). They can be of different sizes, from local end users [4] to district-level systems, such as microgrids (MGs) [5], virtual power plants [6] or energy communities on local or regional scales [3].

MGs are clusters of distributed energy sources, energy vectors and controllable and passive loads, which can act as a single entity. MGs can operate in parallel with the main grid but can also switch to autonomous island mode for a certain period of time [7]. The objectives for the formation and operation of MGs are to fulfil the desired needs of the stakeholders, who can require the increased security of the supply, the prevention of additional investment in grid infrastructure in remote areas, better asset management and, in some cases, lower operational costs. A conceptual principle states that the more flexibility options an MG has, the more likely it will be that it achieves most of its objectives. Ideally, MGs would have technologies suited for any event that appears in the grid and on the market, which could be achieved by using a combination of several energy vectors. In practice, MGs are planned based on the investment costs of the technologies, their rate of return or the preferences of the MG operator or stakeholders. In other words, MGs focus on certain pathways and sets of technologies, e.g., photovoltaic systems (PVs), BESSs and HPs. Each set of technologies has advantages and shortcomings, such as sensitivity to electricity prices or sensitivity to BESS capacity during low electricity production from PV panels (e.g., in winter months). Cooperation between multiple MGs that have different methods of producing energy (e.g., CHP plants) and alternative energy vectors could be beneficial. The goal of this paper is to research the benefits of the cooperation of a cluster of MES MGs and the effects it has on their ability to adjust to uncertain market environments.

As shown in Section 2, most of the existing literature focuses on a single MG or MGs with similar architecture and thus, does not analyse the value or importance of different energy vector MGs nor the potential implications of MG cooperation on the reduction in the risks of uncertainty. Thus, this paper's contributions are summarised below:

- We developed an annual deterministic model to showcase the value of clustered MES MG cooperation based on mutual support and joint market participation compared to individual cases. The model incorporates mutual energy exchange with no charges between the MGs.
- Further, we developed a two-stage stochastic mixed-integer linear optimisation model for the day-ahead scheduling of multiple microgrids, with which the interaction between different multi-energy microgrids was analysed, focusing on the MES value in alleviating the variability and uncertainty of demand, price and RES production.

The rest of the paper is organised as follows: a literature review is provided in Section 2; the model formulation is described in Section 3; case studies are presented in Section 4; the results are outlined in Section 5; and Section 6 lists the main conclusions of the the paper.

2. Literature Review

MESs have been researched through various concepts and models [3], mostly with a focus on the methods for the planning and sizing of MESs [8] or their operation and management considering different flexibility options [9]. Mancarella et al. [10] provided a comprehensive overview of MES approaches from different viewpoints and assessment methods. A techno-economic evaluation of the flexibility of MESs, taking into account investment costs and environmental implications, is outlined in [11]. A modelling framework and potential use cases of an MES as an ancillary service provider were researched in [12]. Many other papers deal with the modelling and analysis of optimal sizing and operation [13,14] or the dynamics of individual MGs [15].

The coordinated operation of several different MGs in an uncertain environment (electricity price, RES production and energy demand) has been a subject gaining increasing attention. However, gaps in the literature are still present, especially in terms of the cooperation of MES MGs and the potential complementarity of energy vectors. Daneshvar et al. [16] proposed a chance-constrained optimisation model of an MG cluster. Four different energy trading models were developed for 16 MGs with the same architecture

but of different sizes. Electricity price and PV production were included as the only uncertainty parameters. It was shown that an MG can obtain both individual and collective benefits when joined in a cluster and operated under the proposed transactive energy scheme. The models included electricity storage and thermal energy storage as flexibility options in MES MGs, without the hydrogen energy vector. A multi-objective coordination of several MGs is presented in [17] with the objectives of cost minimisation and the maximisation of grid independence. It was shown that the cooperation of MGs has the potential to provide savings in greenhouse gas emissions and improve the independence performance index. This approach involved RES production as a stochastic parameter but observed electricity as the only energy carrier, utilising the wider potential of MESs. The free energy trading of MGs, where MGs achieve cost savings based on the transactive energy market, is outlined in [18]. MGs were modelled to achieve 100% RES generation from solar PVs and wind power. It was designed as a combination of IGDT (info-gap decision theory) and stochastic programming, where RES generation was integrated as a stochastic parameter. Khorasany et al. [19] presented a competitive local peer-to-peer (P2P) market for energy trading between multi-carrier energy hubs. In the proposed approach, each energy hub individually optimised its day-ahead schedule before they competed on the local energy market. The uncertainty of prices, energy generation and demand were considered in the day-ahead scheduling of the energy hubs. The framework could include electricity, heat, gas and cooling networks. The hydrogen energy vector was not included. A different perspective and framework were utilised by Morteza et al. [20], who observed a MES retailer that competed in different energy markets with the goal of trading energy bilaterally between consumers. That way, the market risk was transferred from the consumers to the retailer. Their proposal dealt with electricity price and consumption uncertainty from the retailer's perspective using a hybrid robust-stochastic approach. A Lyapunov optimisation framework for energy trading between MES MGs is presented by Zhu et al. [21]. Energy trading was modelled as a double-auction mechanism where MGs submitted buying/selling volumes and prices to an external auctioneer, who afterwards determined the accepted prices and allocated energy to the MGs. It was shown that the inclusion of energy trading between MGs that integrate hydrogen storage and fuel cell vehicles can reduce costs for individual MGs through the proposed method. The MES MGs consisted of the same technologies but with different capacities. Karini et al. [22] proposed an optimisation for energy transactions in multi-MG systems based on a bilevel-leader-multi-follower approach. Here, the uncertainty of RES and market prices were integrated with the model based on scenario generation and scenario reduction techniques. The model showed the efficiency in terms of independence index, energy not supplied and greenhouse gas emissions. The analysis observed only the electricity energy vector. Yang et al. [23] applied the alternating direction method of multipliers (ADMM) algorithm to achieve the distributed optimisation of energy sharing between multi-energy complementary MGs, under which electrical and thermal energy could be shared. The energy production of PVs and loads was modelled as uncertain and the framework foresaw the inclusion of combined cooling, heat and power (CCHP) systems, PVs and demand-side management (DSM) resources, such as EVs/ESSs and thermostatically controlled loads (TCLs). The hydrogen energy vector was not part of the analysis, nor was it included in the research carried out by Cheng et al. [24], who developed a bilevel two-stage framework based on transactive control to achieve the optimal operation of interconnected MESs. At a lower level, each MES defined the setpoints of the flexibility options based on the minimisation problem, while at the upper level, a coordinator was responsible for the minimisation of the total costs of the interconnected MESs whilst respecting the transformer's limitations. The exchange of electricity between MESs was included in the modelling framework, while the stochastic nature of RES was dealt with by a rolling horizon optimisation. It was shown that the approach is effective in solving the optimisation problem and that the cooperation of MESs can achieve a high local accommodation of RES compared to autonomous cases. A decentralised incentive-based MES trading mechanism for a cluster of CCHP-based MGs

was proposed in [25]. Here, MES MGs were grouped in a cluster and an incentive-based trading mechanism was applied to facilitate multi-energy trading among the neighbouring MGs. The method did not consider a coordination centre, rather it applied the ADMM decomposition technique while Nash bargaining theory was used to determine the benefits achieved by each MG. The benefits were allocated based on the designed payment chain. The results demonstrated that the clustering and implementation of multi-energy trading can lead to benefits for individual MES MGs. Here, only the uncertainty of electricity production from PVs and wind power was modelled, and no use of hydrogen energy vector was foreseen. A two-step optimisation strategy for the energy management of an MG is presented in Naz et al. [26]. The paper considered an MG system with similar MGs, only considering electricity as an energy vector. The scheduling strategy was divided into local and global scheduling. Local scheduling was conducted first, where each MG was optimised separately. Afterwards, they communicated their surpluses and deficits in a global scheduling optimisation where local trading was preferred over grid trading, which was only used if needed, thereby improving the self-sufficiency of all MGs. Smith et al. [27] provided a comprehensive review of the possible algorithms concerning MG cooperation control from the standpoint of practical usage. Several different application areas were studied, such as: secondary voltage and frequency control; load sharing; network utilisation; remedial action schemes; and economic dispatch and scheduling.

Khorasany et al. [28] provided an overview of potential designs for local energy trading and market clearing approaches. The provided classification of papers, in terms of addressing network constraints, showed that, roughly, more than half of the papers did not consider the network constraints in the design of the market clearing models and the scheduling of the flexibility options. There are different approaches possible for addressing the network constraints—from considering the external role of the DSO to accepting or rejecting orders during the period between the gate closure and the energy exchange, as proposed by Zhang et al. [29]. The wholesale energy market organisation was reflected upon in this study; however, distribution grid complexity may have a significant requirement for DSOs in order to supervise transactions between many MGs simultaneously, especially considering the recent trend of shortening the trading intervals. Other approaches work on the integration of distribution network constraints in market clearing and scheduling mechanisms. A comprehensive review of the impacts of LEM integration into power systems [30] showed that the integration of network constraints could be carried out through power flow equations, network tariff signals or power loss signals. Further, it highlighted the importance of including the DSO in a decision making process and market mechanism, since it has access to crucial grid information. The impact of peer-to-peer trading between end users from the same neighbourhood on a distribution network was studied in [31]. They concluded that local trading leads to the better utilisation of network assets and a reduction in network losses. In their case, local trading did not have a significant impact on network performance, but the authors concluded that further analyses are still required. Another important aspect to consider in MG operation is voltage and frequency control. Pilehvar et al. [32] proposed a PV-based smart inverter system that improved dynamic response by lowering voltage and frequency deviations during transients.

Local energy trading and control in MGs need communication networks to achieve data exchange and stable MG operation. The authors of [33–35] focused on review of ICT infrastructure that is applicable for the MGs. Moreover, the authors of [36–39] proposed different simulation methods for evaluating the performance of ICT infrastructures and their impact on electric power grids. Communication interfaces should allow bidirectional communication between different controllers [35]. The communication nodes in MGs are created by adding ICT capabilities to the underlying distributed energy resource or component and, in that way, upgrading them to intelligent electronic devices (IEDs) [40] so that they can exchange data and/or control commands. Communication protocols are used to ensure accurate data exchange between communication nodes. A protocol suite consists of layers with an assigned set of functions using one or more protocols [40].

Therefore, data communication networks are usually based on protocol levels according to ISO-OSI (International Standards Organisation/Open Systems Interconnect reference) models [35]. The usual past and present MGs use centralised IA based on a central controller communicating with all MG resources and making decisions. The control is usually implemented by the supervisory control and data acquisition (SCADA) systems [35] that use the enhanced performance architecture (EPA) model [40]. Currently, the visible trend is towards the use of new communication technologies based on the Internet or on the Common Information Model (CIM). The Internet architecture is based on TCP/IP protocol (Transmission Control Protocol and Internet Protocol), which is an effective way of achieving end-to-end communication [35]. This fact led to the evolution of the above-listed protocols towards the Modbus/TCP, DNP3 over TCP and Profinet and allowed them to be integrated into SCADAs. They benefit from the TCP/IP protocol and build upon its capabilities. Communication technologies are used for data transfer between the communication nodes (which are organised under the particular communication architecture), while the data are structured and exchanged in line with the communication protocols. There is a number of communication technologies with corresponding pros and cons [41], and they can generally be classified into wired and wireless technologies [40]. Historically, wired communication technologies have been used in the electrical grid as opposed to wireless technologies because of its increased reliability, security and bandwidth properties [35]. However, an important drawback of wired technologies is the higher deployment cost, which is becoming more important due to the ever-growing need for data exchange. Wireless technologies often have lower installation costs and are, as such, presented as good alternatives [35,40,42].

Based on the presented literature review, it can be concluded that the planning and operation of individual MES MGs are important components of energy transition. On the other hand, the potential benefits and operational aspects of the coordinated operation of several MES MGs under uncertainty is an emerging area on which further research is needed. It is a topic with a growing importance in developing smart energy systems, where local decentralised resources are further utilised and MGs are formed. In our work, we build on the existing literature but provide an overarching comprehensive approach and integrate the uncertainty of production, demand and price. Further, we model the use of electricity, thermal energy, BESSs, natural gas, hydrogen and hydrogen storage across the cooperating MES MGs in the analysed scenarios.

3. Concept and Mathematical Formulation

This chapter provides the detailed concept and mathematical formulation of the MG model.

3.1. Concept of the Microgrid Model

The model considered three MGs containing different architectures and energy vectors. All of the MGs had different ways of producing electricity and storing energy to provide flexibility. Additionally, we assumed that the MGs were located close together so they could trade with each other without paying any network charges. This trading was considered to be free, meaning the MGs were helping to balance each other out on the electricity market. They exchanged information about their surplus and deficit of electricity at any given time, which was then traded between them so that the total cost of operation was minimal.

The principal concept of MES MG cooperation is that multiple MGs trade between each other on the local energy market (LEM). The MGs also participate in an upstream power exchange in terms of the day-ahead market (DAM), as shown in Figure 1. The flow of different energy vectors is defined with coloured lines on the figure: blue for electricity; orange for gas; yellow for heat; grey for hydrogen; and red for the local energy market. Energy conversion devices are represented with square boxes and storage units with tank shapes. The model developed in this paper considered the uncertainty of RES production, MG consumption and electricity price. Forecasting the errors of production and

consumption patterns can lead to an imbalance of planned electricity imports and exports, which may lead to penalties. Electricity price forecasts are used for the positioning of MGs on an electricity DAM. The cooperation of different MGs could thus lead to a reduction in the risk related to forecasting uncertainty.

The model was a two-stage stochastic mixed-integer linear model. Optimisation dealt with the uncertainties by utilising stochastic scenarios in two stages. In the first stage, the decision was made before the realisation of the uncertainty and considering stochastic scenarios. The second stage optimised MG scheduling after the realisation of the stochastic scenarios while considering the decisions from the first stage. The variables in the first stage were persistent in all scenarios and the second stage variables were different for all scenarios.

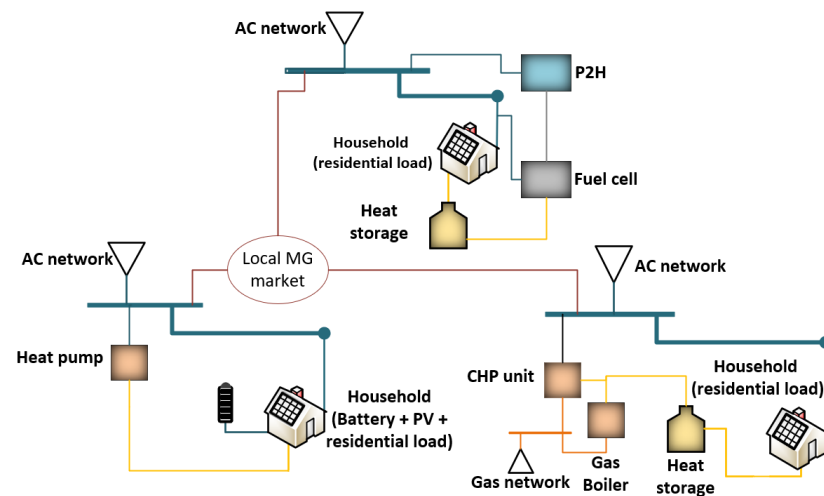

Figure 1. The layout of the MGs.

3.2. Mathematical Formulation

MGs can have different devices to satisfy their various demands. The devices in each MG were defined beforehand by adding the associated variables and constraints to the model of that MG. The energy conversion devices in the model were limited with the maximum and minimum input power presented in (1). The devices included were: a heat pump (HP); a combined heat and power unit (CHP); a boiler; a power-to-hydrogen unit (PtH); and a fuel cell (FC). The charging and discharging power of the storage devices and the state of energy variables were also limited by Equation (1). They were included in battery storage systems and heat storage and hydrogen storage models. The charging and discharging of a storage device could not take place at the same time, thus Equation (2) was added for each storage device. The volume of energy contained in the storage devices (SOE) was calculated using Equation (3), where η^c and η^d denote the charging and discharging efficiencies, if needed. In the aforementioned constraints, “var” is the continuous variable of production/consumption for a specific device and “Xvar” represents the binary variable that indicates if the device is operating. The superscript “c” and “d” in (2) and (3) denote the charge and discharge, respectively. An extra binary variable (start) was needed for the boiler and CHP in order to model their start-up costs. Equation (4) modelled this behaviour by setting the binary variable to “1” if the device had started in that time step. The input and output relationship of the device was different for each of them. The HP used the coefficient of performance (COP) to calculate output power shown in (5). The output from the boiler and the PtH was reduced from their input based on their efficiency, as shown in (6) and (7). The CHP and FC produced two different energy outputs: electricity and heat. They were calculated with two efficiencies, one for electricity and one for heat, as shown in (8) and (9). In Equations (5) and (6), the superscript “O” denotes the output variable. Please note that in order to reduce the number of variables in the model, the output variables

were virtual, i.e., they were not added to the model and were replaced with appropriate expressions.

$$\min \cdot Xvar_{\psi,m,t} \leq var_{\psi,m,t} \leq \max \cdot Xvar_{\psi,m,t} \quad (1)$$

$$Xvar_{\psi,m,t}^c + Xvar_{\psi,m,t}^d \leq 1 \quad (2)$$

$$SOE_{\psi,m,t} = SOE_{\psi,m,t-1} + var_{\psi,m,t}^c \cdot \eta^c - \frac{var_{\psi,m,t}^d}{\eta^d} \quad (3)$$

$$Xvar_{\psi,m,t} - Xvar_{\psi,m,t-1} \leq start_{\psi,m,t} \quad (4)$$

$$v_{\psi,m,t}^O = COP \cdot v_{\psi,m,t} \quad (5)$$

$$b_{\psi,m,t}^O = \eta^b \cdot b_{\psi,m,t} \quad (6)$$

$$p_{\psi,m,t}^O = \eta^p \cdot p_{\psi,m,t} \quad (7)$$

$$c_{\psi,m,t}^{O,el} = \eta^{c,el} \cdot c_{\psi,m,t}, \quad c_{\psi,m,t}^{O,heat} = \eta^{c,heat} \cdot c_{\psi,m,t} \quad (8)$$

$$h_{\psi,m,t}^{O,el} = \eta^{h,el} \cdot h_{\psi,m,t}, \quad h_{\psi,m,t}^{O,heat} = \eta^{h,heat} \cdot h_{\psi,m,t} \quad (9)$$

The interconnections between the devices were handled with energy balancing equations for each energy vector that was present in a specific MG. Each MG was planned based on specific energy vectors: electricity, gas, heat and hydrogen. The devices were either found in households, such as HPs, or there was one centralised unit for the entire MG. Those that were found in households had their value multiplied by the number of households. The heat balance between production and consumption is shown in Equation (10). The electricity balance equation for each hour is presented in (11), summing all of the production and consumption of electricity and exchanging any surpluses and deficits with the electricity market, as well as trading between each MG. The hydrogen energy vector was specific because it could not be bought or sold on any market, thus all produced hydrogen had to be either be consumed or stored, which was enforced with (12). Lastly, the gas energy balance is defined with (13). The gas consumption was summed for the entire optimisation horizon because gas is bought in a single bid for a 24-h period on the day-ahead market. The gas and electricity bid variables (ω_m , $\bar{\epsilon}_{m,t}$ and $\underline{\epsilon}_{m,t}$) were decision variables in the first stage and, as such, had to be valid in each scenario. All other variables were second stage variables. The MGs mutually traded via the variables $\bar{\rho}_{\psi,m,t}$ and $\underline{\rho}_{\psi,m,t}$. The volume that was sold by the MGs had to be equal to the volumes that were bought by the other MGs, which was enforced by (14).

$$N_m \cdot d_{\psi,m,t} = N_m \cdot v_{\psi,m,t}^O - \bar{\alpha}_{\psi,m,t} + \underline{\alpha}_{\psi,m,t} + c_{\psi,m,t}^{O,heat} + b_{\psi,m,t}^O + h_{\psi,m,t}^{O,heat} \quad (10)$$

$$N_m \cdot L_{\psi,m,t} = N_m \cdot PV_{\psi,m,t} - N_m \cdot \bar{\beta}_{\psi,m,t} + N_m \cdot \underline{\beta}_{\psi,m,t} - N_m \cdot v_{\psi,m,t} + c_{\psi,m,t}^{O,el} - p_{\psi,m,t} + h_{\psi,m,t}^{O,el} + \bar{\epsilon}_{m,t} - \underline{\epsilon}_{m,t} + \bar{\rho}_{\psi,m,t} - \underline{\rho}_{\psi,m,t} \quad (11)$$

$$p_{\psi,m,t}^O - \bar{\gamma}_{\psi,m,t} + \underline{\gamma}_{\psi,m,t} - h_{\psi,m,t} = 0 \quad (12)$$

$$\omega_m = \sum_{i=1}^T (c_{\psi,m,i} + b_{\psi,m,i}) \quad (13)$$

$$\sum_{j=1}^M \bar{\rho}_{\psi,j,t} = \sum_{j=1}^M \underline{\rho}_{\psi,j,t} \quad (14)$$

The main goal of the optimisation was to reduce the expected operational costs by considering uncertainty scenarios. The objective function would change slightly depending on different cases, as explained in Section 4, but the general objective function is shown with (15) as the sum of electricity and gas bought/sold from/to the day-ahead market (DAM) multiplied by the price and probability in that scenario. The electricity bought from the DAM had an additional cost in terms of transmission and distribution network

charges. The CHP and boiler start-up costs were also included in the objective function. Please note that in some cases (e.g., yearly analysis), the model would not be considered stochastic but deterministic. In those cases, the same mathematical formulation could be used, considering only one scenario with the probability of “1”.

$$\sum_{j=1}^{\Psi} \sum_{i=1}^T (\bar{\epsilon}_{m,i} \cdot (\pi_{j,m,i} + \tau + \gamma) \cdot \lambda_j - \epsilon_{m,i} \cdot \pi_{j,m,i} \cdot \lambda_j + Start_{j,m,i} \cdot \lambda_j) + \omega_m \cdot G \quad (15)$$

4. Case Studies

The case studies consisted of three MGs following different decarbonisation strategies, as shown in Figure 1. The MGs were considered to be placed in the city of Zagreb, Croatia, and most of the input data were adapted to that city. Each MG was considered as a single low-voltage derivative with 30 households. All of the MGs had a PV unit on every household. The first MG was fully electric and, in addition to the above, contained a battery storage system and heat pump for supplying heating. Heat pump and battery storage systems are localised for each household in an MG. The second MG uses natural gas in the CHP unit for heat and electricity production and in the boiler for heat production. It also utilised heat storage. The third MG used hydrogen technologies. The electrolyser produced hydrogen using electricity, while the fuel cell transformed energy from hydrogen to heat and electricity. It also had hydrogen storage for surplus hydrogen.

The parameters of these devices are summarised in Table 1. Each household contained a PV system with a rated power of 5 kW. The heating units in the MGs were sized so they could provide 10 kW of heating per household, considering efficiencies. The boiler unit was used to support the CHP, so its input power was lower. On summer days when there was no need for heating, the CHP and fuel cell could operate with a thermal efficiency of “0”. The battery storage system was sized so that it had 1 kW and 1 kWh for every 1 kW of installed PV. The heat storage size was determined so it could store an hour’s worth of heat from the CHP. The electrolyser was sized so that it could supply enough hydrogen for the fuel cell for each hour, and the hydrogen storage was sized so that it could store 2 h worth of hydrogen from the electrolyser. The PV production, electricity load and day-ahead electricity price were considered stochastic parameters. The scenarios for PV production were created using [43] with weather data for the city of Zagreb. The electricity load profiles for the households were generated using “LoadProfileGenerator” software [44]. Lastly, the electricity price scenarios were generated with the SARIMA model, using electricity prices from the Croatian power exchange (CROPEX) [45]. A set of prices from 2021 was used, concluding with prices from 12 of November. The year 2021 was chosen so as to better follow current price trends, since the average electricity price increased from EUR 50 MWh in 2019 to EUR 100 MWh and, in the last few months of 2021, to EUR 200 MWh. Each stochastic parameter was made into three scenarios, where the electricity load and PV production had different scenarios for each MG. The electricity price, load and PV production scenarios were combined into nine scenarios with equal probability. The gas price was taken from CEGH VTP (Central European Gas Hub Virtual Trading Point) [46] as an average daily price from 30 of September to 13 of November, and amounted to EUR 85 MWh. The heat consumption was taken from [47] for the city of Indianapolis, USA, since it has a similar climate to Zagreb, Croatia. The transmission and distribution network prices were those set by Croatian TSO and DSO, and were equal to EUR 12 MWh and EUR 29 MWh, respectively. The specific CO₂ emission for the electricity bought from the electricity market was 0.177 kg/kWh [48] and for natural gas was 0.202 kg/kWh [49].

Table 1. The parameters of all devices considered by the MGs.

Device	Input Power	Efficiency	Capacity
Heat Pump (1 per household)	4 kW	COP: 2.5	-
CHP	430 kW	Electric: 22% Thermal: 70%	-
Boiler	180 kW	85%	-
Fuel Cell	580 kW	Electric: 37% Thermal: 52%	-
Electrolyser	880 kW	66%	-
Battery (1 per household)	Charge: 5 kW Discharge: 5 kW	Charge: 90% Discharge: 90%	5 kWh
Heat Storage	Input: 335 kW Output: 335 kW	Input: 90% Output: 90%	335 kWh
Hydrogen Storage	Input: 1200 kW Output: 1200 kW	No losses	1200 kWh

The case study considered two different analyses: a daily stochastic analysis and a yearly analysis. The daily analysis had six different cases, each considering one summer day and one winter day. The yearly analysis had four cases.

The daily stochastic analyses were as follows:

- Case 0 (C0) was a benchmark case with no flexibility nor electricity and hydrogen production. All MGs could only buy electricity from the DAM, they did not have any type of storage and they only used boilers to satisfy heat demand. We did not consider any uncertainty and all scenarios were averaged into one deterministic scenario.
- Case 1 (C1) considered MGs with the architectures described in this chapter. As with C0, it did not consider any uncertainty nor could it trade between MGs. It relied on a technique similar to the concept of net metering for electricity billing, in which a surplus of electricity returned to the grid could be used later to lower the consumer's bill. In our model, net metering was modelled as a virtual storage system in which MGs could withdraw their past surpluses whenever necessary, i.e., netted electricity from a summer day could be transferred to a winter day.
- Case 2 (C2) was a stochastic case utilising scenarios. It could freely trade on the electricity market and between MGs.
- Case 3 (C3) was a sensitivity analysis focused on the gas price increase compared to C2. Two instances were considered. In the first, the price of gas was equal to the average price of electricity (C3.1) while in the second, a price 50% higher than the average price of electricity was considered in the described scenarios (C3.2). The prices amounted to EUR 199 MWh and EUR 298 MWh, respectively.
- Case 4 (C4) was similar to C2; however, it considered that the MGs were located further apart so they had to pay distribution network charges when buying electricity from each other.
- Case 5 (C5) expanded on C4 and considered that the MGs were dislocated and had to pay transmission and distribution network charges when/if buying electricity from each other.

The yearly analyses were as follows:

- Yearly case 1 (Y1) was a yearly analysis based on C2, but without considering any uncertainty.
- Yearly case 2 (Y2) was similar to Y1, with the main difference being that the objective function was changed to maximising self-sufficiency. This meant that the objective function in the model was to minimise the volumes of electricity and gas bought

from the DAMs without considering prices. The total costs were calculated after the optimisation.

- Yearly case 3 (Y3) was again similar to Y1, but this time the main difference was that the objective function was the minimisation of CO₂ emissions. The total costs were calculated after the optimisation.
- Yearly case 4 (Y4) was the same as Y1, but instead of three different MGs, it optimised three MGs of the same kind. This case had three instances: the first with three electric MGs (Y4.E); the second with three gas MGs (Y4.G); and lastly, an instance with three hydrogen MGs (Y4.H).

5. Discussion and Results

This section discusses the results of the case studies. The first three subsections present the results from the daily analyses, focusing on the total operating cost, trading on the DAM and local market and multi-energy flexibility and emissions while dealing with uncertainties. The fourth subsection details the yearly analyses and presents how the different approaches affected the total operating cost, emissions and self-sufficiency. The model was written in Python 3.8 and used the Gurobi 9 optimisation solver [50]. The PC specifications were: AMD Ryzen 5 3600 6-Core 3.59 GHz processor with 16 GB of RAM. The computational time of the stochastic models was around 10 s, while the yearly analyses had a computational time of around 2 min.

5.1. Daily Analyses for the First Three Cases

The first analysis compared C2 to C0 and C1. Table 2 shows the costs per MG for each case on a summer and on a winter day. On a summer day, C2 proved to be much better than the other two cases, while on a winter day, it performed worse than C0 and C1. By adding the cost of both days, we observed that C2 performed 20% worse than C0 and 13% better than C1. The fact that C0 managed to outperform C2 could be explained by the difference between deterministic and stochastic optimisation. As previously mentioned, C2 was a stochastic case study, unlike C0 and C1, which were deterministic. Stochastic models are intrinsically worse than deterministic models since they must adhere to a wide variety of scenarios and be feasible for each of them. In our model, this meant that the stochastic model had to take advantage of all flexibilities that it has at its disposal, which led to higher costs. Please note that neither C0 nor C1 would be able to adhere for all scenarios at once if subjected to stochastic analysis, or would perform very poorly. Although hindered by uncertainties, C2 performed much better than C1 because it could fully utilise all of its production and flexibility on the DAM, while C1 was left with unused netted energy at the end of the optimisation horizon. Figure 2 shows the total energy traded between the MGs in the case of C2, which was the best way to demonstrate the flexibility and the adjustments made to the uncertainties. The gas MG had the lowest local import volumes, on average, for both summer and winter days, while the hydrogen MG had the highest local import in summer and the electric MG had the highest in winter. The gas and hydrogen MGs mostly exported electricity to other MGs on winter days because of their controllable generation from the CHP and fuel cell. On summer days, the electric and gas MGs were the forerunners in exports so as to offset the hydrogen MG's lack of flexibility. From this, it can be concluded that the CHP outperforms the fuel cell in the summer and provides more flexibility in the winter. This is mostly influenced by the price of gas being lower than the price of electricity, on average, and by its invariability. For this reason, we conducted a gas price sensitivity analysis in C3 and discuss it in the following subsection. The import and export ratio is summarised in Table 3. The total emissions are shown in Figure 3. C2's emissions were fairly similar to C0, being only 0.2% lower, and 1.1% lower than C1. The reductions in emissions, though small, was a consequence of the optimisation trying to lower its costs.

Table 2. The total costs (EUR) for cases C0, C1 and C2.

MG	Summer			Winter		
	C0	C1	C2	C0	C1	C2
EE	52.1	7.16	−130.14	313.08	27.67	125.79
Gas	55.2	259.5	−138.9	316.06	259.5	307.82
H2	55.5	170.41	−139.6	316.87	819.81	1310.29
All 3 MGs	162.77	437.07	−408.63	946	1106.98	1743.9

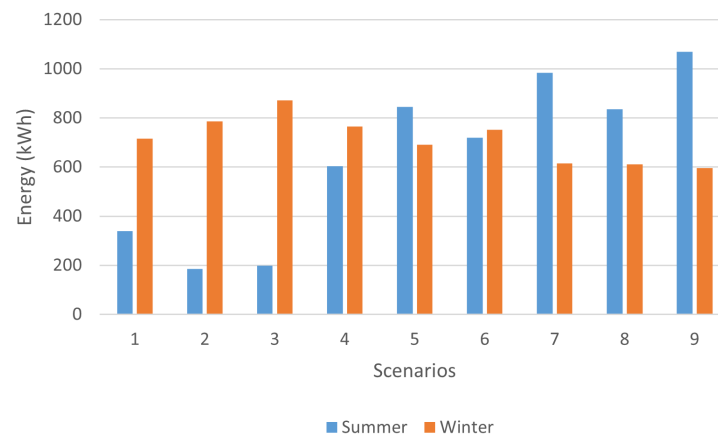
**Figure 2.** The trades between MGs in C2.**Table 3.** The ratio of local import and export for each MG in C2.

MG	Summer		Winter	
	Import	Export	Import	Export
1	24.8%	57.39%	89.49%	0%
2	7.64%	38.85%	0.84%	62.68%
3	67.56%	3.76%	9.66%	37.32%

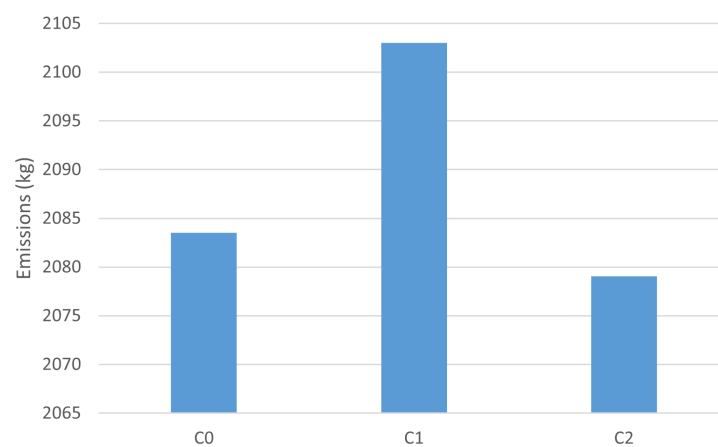
**Figure 3.** The total emissions of CO₂ in C0, C1 and C2.

5.2. Daily Analysis for Case 3

For the two subcases of Case 3, the gas price was set to be equal to the average price of electricity, reflecting the realistic situation of the markets over the last couple of months of 2021. The total costs of both C3 cases increased as expected due to higher gas prices, as

shown in Table 4. An interesting point to note here is that in the summer, the total energy import was much lower than in C2 while in the winter, it was almost the same. This was because the CHP was not being used in the summer due to the price increase, while in the winter, gas consumption was a little lower but was still needed since the gas MG did not have any alternative options for thermal production. This was also reflected in the total cost, where the winter had a much higher cost difference. In the summer, local import increased in favour of selling to the DAM in order to replace the flexibility missing from the lower CHP usage. In the winter, local trade was lower because the marginal price of the most prominent flexibility provider (CHP) increased, thus lowering the potential for local trade. The effect of the gas price increase was that it lowered emissions by 6% in C3.1 and 6.2% in C3.2. This was mostly attributed to the lower gas consumption in summer.

Table 4. The C3 results and a comparison to the C2 results.

	Summer		Winter	
	C3.1	C3.2	C3.1	C3.2
Total cost (EUR)	−387.17	−381.26	2210.2	2565.92
Difference in total cost compared to C2	5.54%	7.17%	21.09%	32.03%
Total energy import difference compared to C2	−167.28%	−167.21%	−0.45%	−0.46%
Total local import difference compared to C2	8.82%	9.01%	−20.41%	−30.51%

5.3. Daily Analysis for Cases Four and Five

Adding new constraints in cases C4 and C5 raised the total costs, as shown in Table 5. Although the increase in cost was not significant, other parameters have changed. Since local trading became more expensive, the gas MG was selling more volume to the DAM than to the local market. Concurrently, the electric and hydrogen MGs were replacing the deficit from the local market with purchases from the DAM. Additionally, the MGs were more reliant on their own flexibility than on the shared flexibility from the different energy vectors. Similarly, the MGs had to disperse their DAM schedule instead of trading at more favourable times. This is seen in Figures 4 and 5, where the C2 curve is more steep than those of C4 and C5. The conclusion to be made here is that, although the schedule of MGs changed significantly, the overall costs did not rise, meaning that the system was showing a significant level of robustness. With the increase in DAM imports and decrease in local imports, the emissions in C4 rose by 3% compared to C2 and by 3.77% compared to C5.

Table 5. The C4 and C5 results and a comparison to the C2 results.

MG	Summer		Winter	
	C4	C5	C4	C5
Total cost (EUR)	−395.56	−390.29	1807.92	1811.88
Difference in total cost compared to C2	3.3%	4.7%	3.54%	3.75%
Total energy import difference compared to C2	19.9%	20.02%	0.97%	1.91%
Total local import difference compared to C2	−30.72%	−37.47%	−50.32%	−60.82%

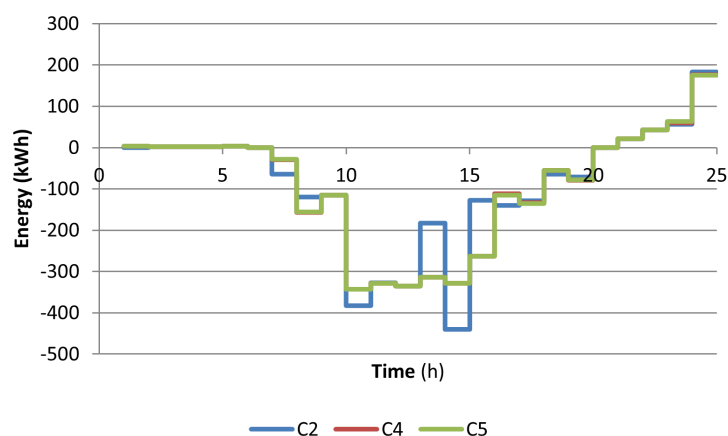

Figure 4. The DAM schedule for summer in C2, C4 and C5.

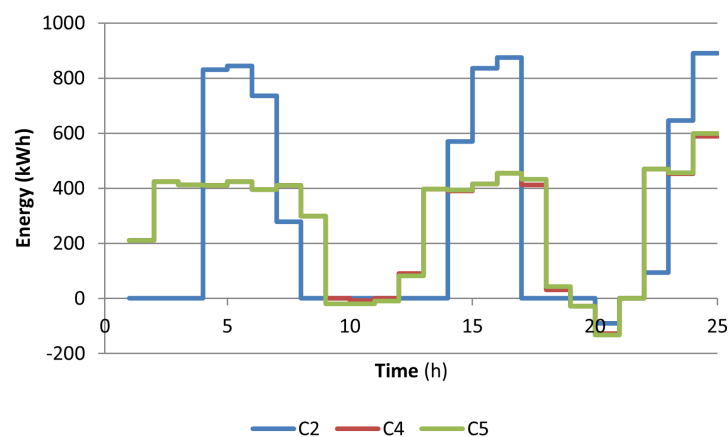

Figure 5. The DAM schedule for winter in C2, C4 and C5.

5.4. Yearly Analysis

The yearly analysis Y1 followed a similar trend as that seen in the daily analyses. The gas MG was the biggest exporter on the local market, while the others were mostly importing from it. Flexibility was used to lower imports to the DAM by adjusting the optimal trade in times. When constrained to a different optimisation approach, i.e., increasing self-sufficiency and lowering emissions, it changed its behaviour, which is shown in Table 6. Both alternative approaches, Y2 and Y3, yielded similar results. Both managed to lower DAM imports and emissions to a similar level, although only one of those goals was set in the objective function. The cost increase was also fairly equal between those two cases. Interestingly, the gas volumes changed a lot between all three cases. The key aspect that differentiated Y2 and Y3 was that Y2 favoured DAM exports over local trading, while Y3 was the opposite. Nevertheless, both cases showed a significant drop in DAM exports. The results from the Y2 and Y3 analyses show that these goals were somewhat correlated to one another.

In the Y4 analysis, it was shown that the purely electric MG (Y4.E) performed the best in terms of total cost and emissions. The gas MG (Y4.G) had a lower total cost than Y1, but at the cost of higher emissions. Lastly, the hydrogen MG (Y4.H) had the highest cost and emissions compared to all of the other cases. The results from the Y4 analysis are summarised in Table 7.

Table 6. The results for yearly analyses Y1, Y2 and Y3.

Case	Total Cost	Emissions	Local Trading	Imported from DAM	Exported to DAM	Gas Import from DAM
Y1	123,122.5	292,846.4	280,105.4	941,901.1	391,514.8	624,405.4
Y2	169,751.4	271,612.7	335,118.9	832,733.1	199,390	614,945.4
Difference between cases Y1 and Y2	27.47%	−7.82%	16.42%	−13.11%	−96.36%	−1.54%
Y3	172,203.3	271,683.5	358,088.6	833,149.6	175,774	614,930.7
Difference between cases Y1 and Y3	28.5%	−7.79%	21.78%	−13.05%	−122.74%	−1.54%

Table 7. The results for the yearly analysis Y4 and a comparison to the Y1 results.

	Y4.E	Y4.G	Y4.H
Total Cost (EUR)	23,610.77	73,631.96	291,046
Difference compared to Y1	80.82%	40.2%	−136.39%
Emissions (kg)	93,823.06	364,346.3	495,686.5
Difference compared to Y1	67.96%	−24.42%	−69.27%

6. Conclusions

The paper aimed to present different decarbonisation techniques for microgrids. We selected three extreme cases: one based on a purely electric architecture, one on a gas architecture and lastly, one on a hydrogen architecture. The local electricity market was included as a way of coupling these MGs together, with the idea that the MGs could provide flexibility between each other without additional costs. Daily and yearly analyses are presented, which analyse different realistic market and system situations. The results are presented in three relevant key performance indicators: the total cost of operation, self-sufficiency and CO₂ emissions. On a yearly level, the conclusions were made that DAM-oriented trading outperformed the electricity netting approach by approximately 13%. This conclusion was confirmed in the sensitivity analyses, where the gas price increased to the record levels noted during the second half of 2021. While the total costs of MG operation increased, the emissions decreased. In the second set of analyses, we ran annual analyses and considered three different optimisation goals showcasing the different mindsets of potential MG investors. When the MG operation was driven either by self-sufficiency or emission reduction goals, the results were very similar. However, they were majorly different from the objective of cost minimisation. Lastly, all decarbonisation MG options were compared to each other by running daily optimisations. The results clearly show that the electric MG performed the best, while the hydrogen MG was the worst. The gas MG option was indicated as a good way to balance RES during the transition towards a highly renewable energy system; however, they were characterised by high dependency on gas prices and much higher emissions.

Author Contributions: Conceptualization and methodology, all authors; software, M.K. and L.H.; validation, all authors; formal analysis, M.K.; investigation and resources, M.K. and L.H.; data curation, M.K. and L.H.; writing—original draft preparation, M.K. and L.H.; writing—review and editing, all authors; visualization, M.K.; supervision, project administration and funding acquisition, T.C. All authors have read and agreed to the published version of the manuscript.

Funding: This research received no external funding.

Institutional Review Board Statement: Not applicable.

Informed Consent Statement: Not applicable.

Data Availability Statement: Not applicable.

Acknowledgments: This work was funded by the European Union through the European Regional Development Fund for the Competitiveness and Cohesion Operational Programme 2014–2020 of the Republic of Croatia under project No. KK.01.1.1.07: “Universal Communication and Control System for Industrial Facilities”. The content of this work is the sole responsibility of the University of Zagreb, Faculty of Electrical Engineering and Computing.

Conflicts of Interest: The authors declare no conflict of interest.

Abbreviations

The following abbreviations are used in this manuscript:

Indices and Variables

Ψ, ψ	Set and index for scenarios
M, m	Set and index for microgrids
T, t	Set and index for hours
$b_{\psi,m,t}$	Input power of boiler in scenario ψ , MG m and time t
$p_{\psi,m,t}$	Input power of PtH in scenario ψ , MG m and time t
$c_{\psi,m,t}$	Input power of CHP in scenario ψ , MG m and time t
$h_{\psi,m,t}$	Input power of FC in scenario ψ , MG m and time t
$v_{\psi,m,t}$	Input power of HP in scenario ψ , MG m and time t
$\bar{\alpha}_{\psi,m,t}$	Heat storage input power in scenario ψ , MG m and time t
$\underline{\alpha}_{\psi,m,t}$	Heat storage output power in scenario ψ , MG m and time t
$\bar{\beta}_{\psi,m,t}$	Battery storage input power in scenario ψ , MG m and time t
$\underline{\beta}_{\psi,m,t}$	Battery storage output power in scenario ψ , MG m and time t
$\bar{\gamma}_{\psi,m,t}$	Hydrogen storage input power in scenario ψ , MG m and time t
$\underline{\gamma}_{\psi,m,t}$	Hydrogen storage output power in scenario ψ , MG m and time t
ω_m	Gas volume bought from day-ahead market in MG m
$\bar{\epsilon}_{m,t}$	Electricity volume bought from day-ahead market in MG m and time t
$\underline{\epsilon}_{m,t}$	Electricity volume sold to day-ahead market in MG m and time t
$\bar{\rho}_{\psi,m,t}$	Electricity volume bought from local MG market in scenario ψ , MG m and time t
$\underline{\rho}_{\psi,m,t}$	Electricity volume sold to local MG market in scenario ψ , MG m and time t

Parameters

η^b	Boiler efficiency coefficient
η^p	PtH efficiency coefficient
$\eta^{c,el}$	CHP electricity output efficiency coefficient
$\eta^{c,heat}$	CHP heat output efficiency coefficient
$\eta^{h,el}$	FC electricity output efficiency coefficient
$\eta^{h,heat}$	FC heat output efficiency coefficient
COP	HP coefficient of performance
N_m	Number of household in MG m
$L_{\psi,m,t}$	Household load in scenario ψ , MG m and time t
$PV_{\psi,m,t}$	PV production in scenario ψ , MG m and time t
$d_{m,t}$	Heat demand in MG m and time t
$\pi_{\psi,m,t}$	Electricity price in scenario ψ , MG m and time t
G	Price of gas
λ_{ψ}	Probability of scenario ψ
τ	Transmission network charges
γ	Distribution network charges

References

1. Pavić, I.; Beus, M.; Pandžić, H.; Capuder, T.; Štritof, I. Electricity markets overview—Market participation possibilities for renewable and distributed energy resources. In Proceedings of the 2017 14th International Conference on the European Energy Market (EEM), Dresden, Germany, 6–9 June 2017; pp. 1–5. [\[CrossRef\]](#)
2. Mancarella, P.; Chicco, G. Real-Time Demand Response from Energy Shifting in Distributed Multi-Generation. *IEEE Trans. Smart Grid* **2013**, *4*, 1928–1938. [\[CrossRef\]](#)
3. Herenčić, L.; Melnjak, M.; Capuder, T.; Andročec, I.; Rajšl, I. Techno-economic and environmental assessment of energy vectors in decarbonization of energy islands. *Energy Convers. Manag.* **2021**, *236*, 114064. [\[CrossRef\]](#)
4. Good, N.; Karangelos, E.; Navarro-Espinosa, A.; Mancarella, P. Optimization under Uncertainty of Thermal Storage-Based Flexible Demand Response with Quantification of Residential Users' Discomfort. *IEEE Trans. Smart Grid* **2015**, *6*, 2333–2342. [\[CrossRef\]](#)
5. Holjevac, N.; Capuder, T.; Zhang, N.; Kuzle, I.; Kang, C. Corrective receding horizon scheduling of flexible distributed multi-energy microgrids. *Appl. Energy* **2017**, *207*, 176–194. [\[CrossRef\]](#)
6. Capuder, T.; Mancarella, P. Assessing the benefits of coordinated operation of aggregated distributed Multi-energy Generation. In Proceedings of the 2016 Power Systems Computation Conference (PSCC), Genoa, Italy, 20–24 June 2016; pp. 1–7. [\[CrossRef\]](#)
7. Hirsch, A.; Parag, Y.; Guerrero, J. Microgrids: A review of technologies, key drivers, and outstanding issues. *Renew. Sustain. Energy Rev.* **2018**, *90*, 402–411. [\[CrossRef\]](#)
8. Sachs, J.; Sawodny, O. Multi-objective three stage design optimization for island microgrids. *Appl. Energy* **2016**, *165*, 789–800. [\[CrossRef\]](#)
9. Parisio, A.; Del Vecchio, C.; Vaccaro, A. A robust optimization approach to energy hub management. *Int. J. Electr. Power Energy Syst.* **2012**, *42*, 98–104. [\[CrossRef\]](#)
10. Mancarella, P. MES (multi-energy systems): An overview of concepts and evaluation models. *Energy* **2014**, *65*, 1–17. [\[CrossRef\]](#)
11. Mancarella, T.C.P. Techno-economic and environmental modelling and optimization of flexible distributed multi-generation options. *Energy* **2014**, *71*, 516–533. [\[CrossRef\]](#)
12. Mancarella, P.; Chicco, G.; Capuder, T. Arbitrage opportunities for distributed multi-energy systems in providing power system ancillary services. *Energy* **2018**, *161*, 381–395. [\[CrossRef\]](#)
13. Holjevac, N.; Capuder, T.; Kuzle, I. Defining Key Parameters of Economic and Environmentally Efficient Residential Microgrid Operation. *Energy Procedia* **2017**, *105*, 999–1008. [\[CrossRef\]](#)
14. Shilaja, C.; Arunprasath, T.; Priya, P. Day-ahead optimal scheduling of microgrid with adaptive grasshopper optimization algorithm. *Int. J. Commun. Syst.* **2019**, *35*, e4133.
15. Karimi, A.; Khayat, Y.; Naderi, M.; Dragičević, T.; Mirzaei, R.; Blaabjerg, F.; Bevrani, H. Inertia Response Improvement in AC Microgrids: A Fuzzy-Based Virtual Synchronous Generator Control. *IEEE Trans. Power Electron.* **2020**, *35*, 4321–4331. [\[CrossRef\]](#)
16. Daneshvar, M.; Mohammadi-Ivatloo, B.; Asadi, S.; Anvari-Moghaddam, A.; Rasouli, M.; Abapour, M.; Gharehpetian, G.B. Chance-constrained models for transactive energy management of interconnected microgrid clusters. *J. Clean. Prod.* **2020**, *271*, 122177. [\[CrossRef\]](#)
17. Karimi, H.; Jadid, S. Optimal energy management for multi-microgrid considering demand response programs: A stochastic multi-objective framework. *Energy* **2020**, *195*, 116992. [\[CrossRef\]](#)
18. Daneshvar, M.; Mohammadi-ivatloo, B.; Zare, K.; Asadi, S.; Anvari-Moghaddam, A. A Novel Operational Model for Interconnected Microgrids Participation in Transactive Energy Market: A Hybrid IGDT/Stochastic Approach. *IEEE Trans. Ind. Inform.* **2020**, *17*, 4025–4035. [\[CrossRef\]](#)
19. Khorasany, M.; Najafi-Ghalelou, A.; Razzaghi, R.; Mohammadi-Ivatloo, B. Transactive Energy Framework for Optimal Energy Management of Multi-Carrier Energy Hubs under Local Electrical, Thermal, and Cooling Market Constraints. *Int. J. Electr. Power Energy Syst.* **2021**, *129*, 106803. [\[CrossRef\]](#)
20. Zare Oskouei, M.; Mirzaei, M.A.; Mohammadi-Ivatloo, B.; Shafiee, M.; Marzband, M.; Anvari-Moghaddam, A. A hybrid robust-stochastic approach to evaluate the profit of a multi-energy retailer in tri-layer energy markets. *Energy* **2021**, *214*, 118948. [\[CrossRef\]](#)
21. Zhu, D.; Yang, B.; Liu, Q.; Ma, K.; Zhu, S.; Ma, C. Energy trading in microgrids for synergies among electricity, hydrogen and heat networks. *Appl. Energy* **2020**, *272*, 115225. [\[CrossRef\]](#)
22. Karimi, H.; Bahmani, R.; Jadid, S.; Makui, A. Dynamic transactive energy in multi-microgrid systems considering independence performance index: A multi-objective optimization framework. *Int. J. Electr. Power Energy Syst.* **2020**, *126*, 106563. [\[CrossRef\]](#)
23. Yang, Z.; Hu, J.; Ai, X.; Wu, J.; Yang, G. Transactive Energy Supported Economic Operation for Multi-Energy Complementary Microgrids. *IEEE Trans. Smart Grid* **2021**, *12*, 4–17. [\[CrossRef\]](#)
24. Cheng, Y.; Zhang, P.; Liu, X. Collaborative Autonomous Optimization of Interconnected Multi-Energy Systems with Two-Stage Transactive Control Framework. *Energies* **2020**, *13*, 171. [\[CrossRef\]](#)
25. Guo, J.; Tan, J.; Lia, Y.; Gu, H.; Liu, X.; Cao, Y.; Yan, Q.; Xu, D. Decentralized Incentive-based multi-energy trading mechanism for CCHP-based MG cluster. *Int. J. Electr. Power Energy Syst.* **2021**, *133*, 107138. [\[CrossRef\]](#)
26. Naz, K.; Zainab, F.; Mehmood, K.K.; Bukhari, S.B.A.; Khalid, H.A.; Kim, C.H. An Optimized Framework for Energy Management of Multi-Microgrid Systems. *Energies* **2021**, *14*, 6012. [\[CrossRef\]](#)

27. Smith, E.; Robinson, D.; Agalgaonkar, A. Cooperative Control of Microgrids: A Review of Theoretical Frameworks, Applications and Recent Developments. *Energies* **2021**, *14*, 8026. [[CrossRef](#)]
28. Khorasany, M.; Mishra, Y.; Ledwich, G. Market Framework for Local Energy Trading: A Review of Potential Designs and Market Clearing Approaches. *IET Gener. Transm. Distrib.* **2018**, *12*, 5899–5908. [[CrossRef](#)]
29. Zhang, C.; Wu, J.; Zhou, Y.; Cheng, M.; Long, C. Peer-to-Peer energy trading in a Microgrid. *Appl. Energy* **2018**, *220*, 1–12. [[CrossRef](#)]
30. Dudjak, V.; Neves, D.; Alskaf, T.; Khadem, S.; Pena-Bello, A.; Saggese, P.; Bowler, B.; Andoni, M.; Bertolini, M.; Zhou, Y.; et al. Impact of local energy markets integration in power systems layer: A comprehensive review. *Appl. Energy* **2021**, *301*, 117434. [[CrossRef](#)]
31. Hayes, B.; Thakur, S.; Breslin, J. Co-simulation of electricity distribution networks and peer to peer energy trading platforms. *Int. J. Electr. Power Energy Syst.* **2020**, *115*, 105419. [[CrossRef](#)]
32. Pilehvar, M.S.; Mirafzal, B. PV-Fed Smart Inverters for Mitigation of Voltage and Frequency Fluctuations in Islanded Microgrids. In Proceedings of the 2020 International Conference on Smart Grids and Energy Systems (SGES), Perth, Australia, 23–26 November 2020; pp. 807–812. [[CrossRef](#)]
33. Bani-Ahmed, A.; Weber, L.; Nasiri, A.; Hosseini, H. Microgrid communications: State of the art and future trends. In Proceedings of the 2014 International Conference on Renewable Energy Research and Application (ICRERA), Milwaukee, WI, USA, 19–22 October 2014; pp. 780–785. [[CrossRef](#)]
34. Safdar, S.; Hamdaoui, B.; Cotilla-Sanchez, E.; Guizani, M. A survey on communication infrastructure for micro-grids. In Proceedings of the 2013 9th International Wireless Communications and Mobile Computing Conference (IWCMC), Sardinia, Italy, 1–5 July 2013; pp. 545–550. [[CrossRef](#)]
35. Marzal, S.; Salas, R.; González-Medina, R.; Garcerá, G.; Figueres, E. Current challenges and future trends in the field of communication architectures for microgrids. *Renew. Sustain. Energy Rev.* **2018**, *82*, 3610–3622. [[CrossRef](#)]
36. Garau, M.; Celli, G.; Ghiani, E.; Pilo, F.; Corti, S. Evaluation of Smart Grid Communication Technologies with a Co-Simulation Platform. *IEEE Wirel. Commun.* **2017**, *24*, 42–49. [[CrossRef](#)]
37. Li, W.; Ferdowsi, M.; Stevic, M.; Monti, A.; Ponci, F. Cosimulation for Smart Grid Communications. *IEEE Trans. Ind. Inform.* **2014**, *10*, 2374–2384. [[CrossRef](#)]
38. Bhattarai, B.P.; Lévesque, M.; Bak-Jensen, B.; Pillai, J.R.; Maier, M.; Tipper, D.; Myers, K.S. Design and Cosimulation of Hierarchical Architecture for Demand Response Control and Coordination. *IEEE Trans. Ind. Inform.* **2017**, *13*, 1806–1816. [[CrossRef](#)]
39. Findrik, M.; Smith, P.; Kazmi, J.H.; Faschang, M.; Kupzog, F. Towards secure and resilient networked power distribution grids: Process and tool adoption. In Proceedings of the 2016 IEEE International Conference on Smart Grid Communications (SmartGridComm), Sydney, Australia, 6–9 November 2016; pp. 435–440. [[CrossRef](#)]
40. Kuzlu, M.; Pipattanasomporn, M. Assessment of communication technologies and network requirements for different smart grid applications. In Proceedings of the 2013 IEEE PES Innovative Smart Grid Technologies Conference (ISGT), Washington, DC, USA, 24–27 February 2013; pp. 1–6. [[CrossRef](#)]
41. Jogunola, O.; Ikpehai, A.; Anoh, K.; Adebisi, B.; Hammoudeh, M.; Son, S.Y.; Harris, G. State-Of-The-Art and Prospects for Peer-To-Peer Transaction-Based Energy System. *Energies* **2017**, *10*, 2106. [[CrossRef](#)]
42. Ho, Q.D.; Gao, Y.; Le-Ngoc, T. Challenges and research opportunities in wireless communication networks for smart grid. *IEEE Wirel. Commun.* **2013**, *20*, 89–95. [[CrossRef](#)]
43. Pfenninger, S.; Staffell, I. Long-term patterns of European PV output using 30 years of validated hourly reanalysis and satellite data. *Energy* **2016**, *114*, 1251–1265. [[CrossRef](#)]
44. Pflugradt, N.; Muntwyler, U. Synthesizing residential load profiles using behavior simulation. *Energy Procedia* **2017**, *122*, 655–660. [[CrossRef](#)]
45. Croatian Power Exchange. Available online: <https://www.cropex.hr> (accessed on 20 November 2021).
46. Spot Market Data | CEGH VTP. Available online: <https://www.powernext.com/spot-market-data> (accessed on 20 November 2021).
47. Office of Energy Efficiency & Renewable Energy. Commercial and Residential Hourly Load Profiles for all TMY3 Locations in the United States. Available online: tinyurl.com/ybhrjuj6 (accessed on 20 November 2021).
48. *Greenhouse Gas Emission Intensity of Electricity Generation by Country*; European Environment Agency: København, Denmark, 2021.
49. Penman, J.; Gytarsky, M.; Hiraishi, T.; Irving, W.; Krug, T. *2006 IPCC Guidelines for National Greenhouse Gas Inventories*; Prepared by the National Greenhouse Gas Inventories Programme; IGES: Miuragun, Japan, 2006.
50. Gurobi Optimization, LLC. *Gurobi Optimizer Reference Manual*; Gurobi Optimization, LLC: Beaverton, OR, USA, 2021.

Mathematical model of flexible multi-energy industrial prosumer under uncertainty

Matija Kostelac, Ivan Pavić, Tomislav Capuder
 Faculty of Electrical Engineering and Computing
 University of Zagreb, Zagreb, Croatia
 {matija.kostelac, ivan.pavic, tomlav.capuder}@fer.hr

Abstract— In traditional power systems production always followed consumption, while nowadays consumers are incentivized to take active part in electricity markets. In energy intensive industry large portion of the product cost goes to energy expenses. Thus, optimizing operations based on market signals can create substantial benefits for industrial prosumers. Industries with more than one energy input vector, e.g. electricity and gas, both being bought from their respective day ahead markets are investigated in this paper. The paper introduces enthalpy modeling versus conventional mass flow which increases the scheduling efficiency. Proposed optimization model is based on stochastic mixed integer linear programming where prices of electricity are treated as stochastic process as oppose to deterministic approach usually used. Goal of optimization is to reduce overall energy cost. Also, it must provide bidding strategy for both day-ahead markets. Idea is to reduce market variability by proper device scheduling, utilizing flexibility between energy vectors and behind the meter production of electricity.

Keywords—Energy markets, Industrial prosumer, Multi-Energy system, Stochastic optimization

NOMENCLATURE

h	Set of hours
s	Set of scenarios
pl	Set of pressure levels
l	Set of motor loads
m	Set of electric motors
g	Set of gas motors
b	Set of boilers
v	Set of valves
t	Set of turbines
$E_{s,e,h}$	Continuous variable for electric motors
$XE_{s,e,h}$	Binary variable for electric motors
$G_{s,g,h}$	Continuous and binary variable for gas motors
$XG_{s,g,h}$	Binary variable for gas motors
$B_{s,b,h}$	Continuous variable for boilers
$XB_{s,b,h}$	Binary variable indicating on state for electric boilers
$XBW_{s,b,h}$	Binary variable indicating warm state for electric boilers
$XBC_{s,b,h}$	Binary variable indicating cold state for electric boilers
$XBWS_{s,b,h}$	Binary variable indicating start from warm state for electric boilers
$XBCS_{s,b,h}$	Binary variable indicating start from cold state for electric boilers
b_b^{loss}, k	Boiler conversion parameters
$V_{s,v,h}$	Continuous variable for valves
$XV_{s,v,h}$	Binary variable for valves
v_v^{loss}	Valve losses coefficient
$T_{s,t,h}$	Continuous variable for turbine
$XT_{s,t,h}$	Binary variable for turbine
T_t^{loss}	Losses inside turbine
HtP_t	Turbine heat to power ratio
GEN_t^{loss}	Losses inside generator
$L_{s,l,h}$	Motor load

$HD_{s,pl,h}$	Heat demand
CC_h	Constant consumption
I	Incident matrices
ME_h	Volume of electricity bought from the day-ahead market
MG	Volume of gas bought from the day-ahead market
$Sell_{s,h}$	Electricity bought from intraday market
$Buy_{s,h}$	Electricity sold to intraday market
PG	Price of gas
$PE_{s,h}$	Price of electricity
λ_s	Probability of scenarios

I. INTRODUCTION

Production costs in energy-intensive industries (e.g. petrochemical) strongly depend on the costs of purchased energy. To keep them as low as possible, those industries must make their energy procurement more efficient. Current energy markets (e.g. electricity, gas) allow activation of such consumers where they can lower the price of purchased energy if they can adjust to the market prices or if they can adjust their actual consumption to the planned consumption. The paper presents a two-stage stochastic mixed integer linear program (MILP) with recourse of multi-energy industrial plant with its own generation of electrical and heat energy. Model plans operation of plant under uncertainty while trying to reduce overall operational cost. It performs inner arbitrage by shifting between energy vectors and maintaining the quality of supply while competing on electricity and gas markets. This means that the dispatch of industrial plant components is driven by operational cost minimization, replacing one energy resource with another e.g. a decision to consume more gas to produce more steam for turbines when the price of gas is lower than the price of electricity at the market. Alternatively, this model can be used to show how certain device is behaving in relations to other devices and the whole plant. It can serve as an indicator to how removal, replacement or purchase of new devices can impact plant's operation.

In [1]–[3] optimization of petrochemical plant is presented. They use mass flow modeling without losses, and they do not have electric part of the plant modeled. Constrains in [1] and [2] are made for specific plant in question and in [3] are written in general. Reference [3] uses mass flow as a variable but calculates energy assuming constant enthalpy of steam at each level with which they can calculate constant losses. Example of medium-term optimization is done in [4], where they mostly focus on investments and finding best equipment for their plant. Model proposed here was mostly influenced with the models made in [5] and [6], especially the way certain devices are modeled. They mostly concentrate on steam part of the plant and selling produced electricity to power system. Both [5] and [6] put emphasis on very detailed optimization model. Additionally, reference [6] has a model for pollution emissions. Our proposed model implements several additions where the most notable are the steam enthalpy flow and stochastic approach. Two-stage stochastic

MILP is used in [7] for optimization of balancing groups through flexible loads. Although, the subject of optimization is different, concept of using two-stage stochastic optimization for market bidding and using flexible loads is similar. Reference [8], [9] provide great insight to multienergy systems. They provide different concepts for cooperation of electricity and gas. Optimization concept from [8] is very similar to one used in this paper. In [10], they provide examples on two-stage models for competing on electricity market and deal with energy procurement from market by consumers with which proposed model was inspired. Reference [11] shows how energy management in energy-intensive industry is, to a large extent, neglected and proposes a way to improve it. Models for devices are made to be as similar in its behavior as their real counterparts are, while remaining linear. Parameters and data for these models was mostly used from [12]–[14]. Reference [15] provides bibliographical survey about unit commitment in power systems and generic formulation for common problems. A few of the generic formulations are used in our model since problem at hand is, in terms of modeling, very similar to unit commitment problem.

Proposed paper has two major contributions:

- Modelling of energy flows through all components is based on enthalpy, as oppose to mass flow modelling usually done in research, which enables precise representation of operational points and calculation of losses inside turbines, generators and valves. The value of this approach is demonstrated by comparing the results, showing different operational costs and dispatch points depending on the modelling method.

- The two-stage optimization model for industrial plant represents a realistic case faced by the plant operator. It models decisions depending on the decision stage (time frame) as well as takes advantage of flexibility inside the plant to improve trading on electricity and gas market. Unlike deterministic approaches that anticipate prices beforehand, this model uses scenarios-based predictions to schedule its operation.

The remaining of the paper is organized as follows. Section II presents concept and mathematical formulation for our model. Section III presents case study with input parameters and results. Section IV concludes the paper.

II. MODEL DESCRIPTION

This section consists of two parts. First part elaborates on what is the main conceptual difference and what are assumed benefits of proposed model in comparison to other models which can be found in literature. The second thoroughly describes mathematical framework behind the proposed model.

A. Concept

Proposed model utilizes energy flow of steam instead mass as it has been most frequently used. There are several benefits of utilizing this approach and they will be highlighted using illustrations on fig 1 and 2. We will assume a plant with only one boiler (B), two pressure levels (PL), one letdown valve (V) and one turbine (T) with a coupled generator (Ge). At each pressure level we have a demand for heat (HD) that must be satisfied. Losses inside the pipelines are neglected. Equation (1) calculates losses inside the turbine and equation

(2) calculates output electric power by using turbines heat-to-power ratio (HtP). Boiler's and valve's losses are calculated through efficiency coefficients as shown in (3) and (4).

$$T^{out} = T^{in} * \frac{T^{loss}}{1 + HtP} \quad (1)$$

$$T^{el} = T^{out} * HtP * (1 - GEN^{loss}) \quad (2)$$

$$V^{out} = V^{in} * v^{loss} \quad (3)$$

$$B^{out} = B^{in} * b^{loss} + k \quad (4)$$

In mass flow models all efficiencies are equal to “1” (i.e. all energy losses are zero) and heat-to-power ratio becomes mass-to-power ratio. Also, in (1) output flow is equal to input flow. Mass flow is governed by continuity equation which says that the mass flow rate that enters the system is equal to the rate at which mass leaves the system. This means that for the same input valves and turbines have exactly the same steam output, but turbines additionally also produce electrical energy. Problem arises from the fact that in this way electrical energy was produced out of nothing, since input and output is the same in turbines and valves. Modeling in this way makes turbines far superior. On the other hand, we can use energy flow which is governed by energy conservation law which says that total energy inside the isolated system remains constant. Applying this law to valves and turbines means that input energy must be equal to output energy and losses. Turbines have two outputs: electrical energy and heat; while valves have only heat output. Figures 1 and 2 shows two different paths, through turbine and valve, for both flow models. Input power of turbine and valve is increased in case of energy flow to satisfy losses and to account for produced electricity in case of turbines. Given this increase boilers need to use more gas to satisfy demand.

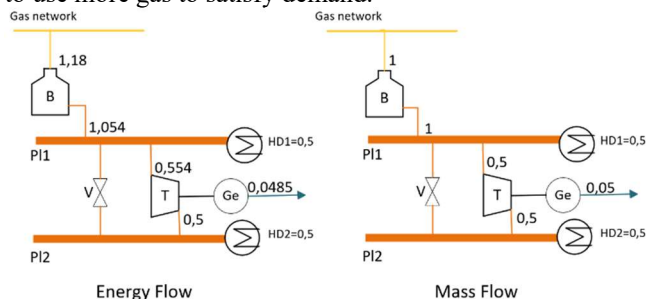

Fig. 1. Energy and mass flow through turbine

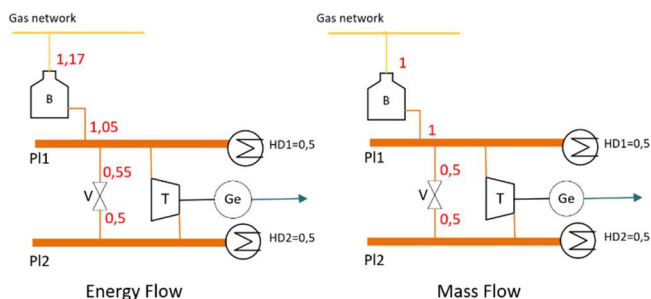

Fig. 2. Energy and mass flow through valve

In total three models are built:

- Stochastic Mixed Integer Linear Program STMILP: proposed model
- Efficiency and Market Model EMM: testing model

- Business as Usual BaU: testing model

The proposed STMILP model is designed as a two-stage stochastic mixed integer linear program with recourse stage. Goal is to provide best strategy for bidding on electricity and gas markets while maintaining minimal operational costs in all scenarios. It is considered that user is a price taker in both markets and is considered to be perfectly inelastic in terms of market clearing. Two different stochastic processes exist in this model. First one is day ahead price of electricity and second one is consumption of electricity and steam. These stochastic processes are represented by set of scenarios.

In the first stage model makes a decision before the realization of stochastic process, commonly referred to as *here-and-now* variables. Proposed model decides on volumes that need to be bought from gas and electricity day-ahead market and plans for its position on balancing market. Those volumes must be taken from the grid regardless of the actual price realizations. Second stage is the actual realization based on the first stage decision and created scenarios. Different decision variables are defined and solved for each scenario, commonly referred to *wait-and-see* decision.

Last stage, referred to as *recourse* stage, happens when the day ahead market is already settled. While second stage uses scenario prices as price realization, recourse stage uses real prices from day ahead market after the gate closure. Recourse stage must abide to choices made in first stage, but it can use its inner flexibility and balancing market to reduce operational cost. Optimal function of first and second stage is expected cost based on scenarios and of recourse stage is cost based on settled prices.

To show strengths of these concepts two test models are created: EMM and BaU. The first one (EMM) uses optimization but to a lesser extent. It utilizes mass flow, doesn't consider price of electricity and gas and uses average consumption scenario, though it still must make bids on electricity and gas markets. After it makes bids recourse stage is employed which takes losses in to account and must settle excess or shortage of electricity using balancing market. Its optimization goal is plant's operation efficiency. Main idea here is to show benefits of stochastic approach and energy flow.

The second test model (BaU) doesn't have any flexibility in its operation. No flexibility means that there is no coupling between electric and heat parts of the system and devices that will be used are predetermined. It must make bids on day-ahead market and must settle excess or shortage of electricity using balancing market. This test model only calculates cost and does balancing on balancing market which doesn't require optimization. BaU model represents a passive way of operating a plant.

B. Mathematical Framework

Linear mathematic models are created for following devices: electric motors (E), gas motors (G), boilers (B), back pressure turbines (T) and generators, letdown valves (V) and release valve (RV). When referring to specific device's variable in equations we will use their symbol written in brackets and its lowercase variant for set of that device. Sets of scenarios and hours are denoted by letters "s" and "h" respectively. All constraints are employed in all stages unless specifically mentioned. Equations (5)-(7) are universal for all devices

except release valves. They restrict minimum and maximum power and change in power of the device. Symbol "Var" and "set" denotes continuous variables and sets for each device respectively. Release valve is connected on lowest pressure level and is not constrained by maximum power.

$$Min_{set} \leq Var_{s,set,h} \leq Max_{set} \quad (5)$$

$$Var_{s,set,h} - Var_{s,set,h-1} \leq Ramp_{up_{set}} \quad (6)$$

$$Var_{s,set,h-1} - Var_{s,set,h} \leq Ramp_{down_{set}} \quad (7)$$

Turbines use one continuous variable for input power while output and electric power are calculated using (1) and (2) when needed. Boilers can be in three different states: on state, and cold and warm off states as discussed in [5]. Warm state means that boiler hadn't had time to cool off and it requires less gas to start it. Average time needed for boiler to cool off (B_{crt}) is inputted as a constant. Three different binary variables are used for tracking state at which boiler is and two binary variables that indicate from which state boiler started. State variable are "XB", "XBW" and "XBC" indicating on, warm and cold state respectively. Startup variable are denoted as "XBWS" and "XBCS" for warm and cold startup respectively. Equation (8) enforces that boiler must enter warm state after it has stopped working and (9) enforce switch from warm to cold state when cooldown time has elapsed. Boiler can only be in one state at a time which is enforced with (10). Equations (11) and (12) forbid changes from cold to warm state and from on to cold state, respectively. Boiler startup is governed with (13) for warm start and (14) for cold start. Equation (15) says that boiler cannot start if it stopped working, (16) and (17) disables warm and cold start if boiler is in cold or warm state (if the boiler has started it needs to be in on state).

$$XBW_{s,b,h} \geq XB_{s,b,h-1} - XB_{s,b,h} + XBW_{s,b,h-1} - XBC_{s,b,h} \quad (8)$$

$$XBC_{s,b,h} \geq \sum_{i=h-B_{crt_b}}^h XBW_{s,b,i} - B_{crt_b} - XB_{s,b,h} + \sum_{j=h-B_{crt_b}}^h XBC_{s,b,j} + 1 \quad (9)$$

$$XB_{s,b,h} + XBW_{s,b,h} + XBC_{s,b,h} = 1 \quad (10)$$

$$XBW_{s,b,h} + XBC_{s,b,h-1} \leq 1 \quad (11)$$

$$XBC_{s,b,h} + XB_{s,b,h-1} \leq 1 \quad (12)$$

$$XBW_{s,b,h-1} - XBW_{s,b,h} - XBC_{s,b,h} \leq XBWS_{s,b,h} \quad (13)$$

$$XBC_{s,b,h-1} - XBC_{s,b,h} \leq XBCS_{s,b,h} \quad (14)$$

$$XB_{s,b,h-1} + XBWS_{s,b,h} + XBCS_{s,b,h} \leq 1 \quad (15)$$

$$XBC_{s,b,h} + XBW_{s,b,h} + XBWS_{s,b,h} \leq 1 \quad (16)$$

$$XBC_{s,b,h} + XBW_{s,b,h} + XBCS_{s,b,h} \leq 1 \quad (17)$$

The layout of industrial plant is inputted in form of matrices "I". They are numerated with a subscript in range from 1 to 5 and correspond to electric motors, gas motors, boilers, letdown valves and turbines respectively (I matrix example is shown in Table I). If device provide energy, value in matrix is "1" and if it takes energy, value is "-1", otherwise it is "0".

Equations (18) and (19) are used for connecting the device to corresponding consumption, (18) for electric load “L” and (19) for heat demand. In (19) if value in “ I_4 ” and “ I_5 ” is equal “-1” decision variable for that device is used instead of V’ and TR’, while if it is equal to “1” TR’ and V’ is replaced with expressions from (1) and (3) respectively. TRⁱⁿ and Vⁱⁿ, in (1) and (3), are replaced with corresponding decision variable. Two new sets are introduced “l” for load coupling and “pl” for pressure levels.

$$L_{s,l,h} = \sum_{i=1}^e (I_{1,t,i} E_{s,i,h}) + \sum_{j=1}^g (I_{2,t,j} G_{s,j,h}) \quad (18)$$

$$HD_{s,pl,h} = \sum_{i=1}^b (I_{3,pl,i} B_{s,i,h}) + \sum_{j=1}^v (I_{4,pl,j} V'_{s,j,h}) + \sum_{k=1}^t (I_{5,pl,k} T'_{s,k,h}) \quad (19)$$

Next two equations, (20) and (21), are different for each of the stages of optimization. In first stage “ME” and “MG” are decision variables while in the second and recourse stage they are constants imported from first stage. With (20) we sum up total volume of electricity needed in each hour which must be equal for every scenario, while with (21) total volume of gas needed in a day is summed. Constant consumption is denoted by “CC”. Buy and sell are decision variables representing volumes that are or will be bought or sold on balancing market.

$$ME_h = \sum_{i=1}^e E_{s,i,h} - \sum_{j=1}^t T_{s,j,h}^{el} + CC_h + Sell_{s,h} - Buy_{s,h} \quad (20)$$

$$MG = \sum_{z=1}^h \left(\sum_{i=1}^g G_{s,i,z} + \sum_{j=1}^b (B_{s,j,z} B_j^{cf}) \right) \quad (21)$$

Objective function is total energy consumed from markets multiplied by cost of it as shown in (22). Prices on balancing market are 70% of spot price for selling and 140% of spot price for buying electricity.

$$cost = \sum_{k=1}^t \sum_{i=1}^t \left((ME_i - Sell_{k,i} * 0,7 + Buy_{k,i} * 1,4) * PE_{k,i} \lambda_s \right) + MG * PG \quad (22)$$

III. CASE STUDY

In this section we will compare results of proposed model with results from test models. First section will explain input parameters for case study. Since there are a lot of technical parameters, most of them will not be shown numerically but only explained in text. Second section will show and interpret obtained results. Measurement units used are: megawatts for power ratings, megawatt-hours for energy, hours for time and euros for price. Model is written in Python 3.7 and it is using Gurobi optimization solver [16]. PC specifications are AMD Ryzen 5 3600 6-Core 3.59 GHz processor and 16 GB of RAM. First and second stage finished in 126 seconds and recourse stage finished in 0.17 seconds.

A. Input parameters

Fig. 3 shows layout of industrial plant that will be used in this case study. Yellow, orange and blue lines show gas, heat and electricity flow between devices and the system respectively. Example of “I” matrix is given in table 1, it is used to connect turbines to pressure levels. As shown in the figure 3, plant consist of three electrical and gas motors, one of each connected together so the model can interchange between them. Motors coupled together have the same parameters only difference being their driving fuel. Plant also has three boilers with various power ratings, ramp power and startup cost. For reducing steam pressure plant can use either letdown valves, back pressure turbines or both, which are connected between each pressure level. Both letdown valves and both back pressure turbines have the same parameters. One release valve is connected on the lowest pressure level.

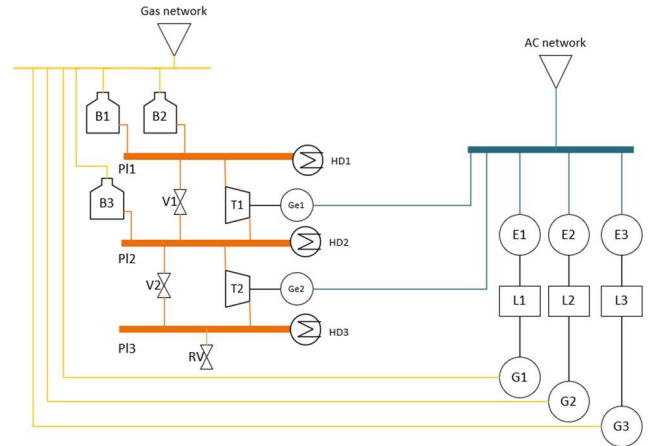

Fig. 3. Industrial plant layout

TABLE I. MATRIX I_5

Pressure level: /Turbine:	1	2
1	-1	0
2	1	-1
3	0	1

For first and second stage of optimization we will use three predicted scenarios for prices of electrical energy (PP) and 3 predicted scenarios for consumption (C). PP was taken from Croatian power exchange [17]. This means the model have total of nine scenarios in first two stages. Prices in scenarios follow normal daily price curve as shown in fig. 4. Every consumption scenario has 5% lower consumption than the last one. They represent process scheduling of the plant and possible deviations. Occurrence probability of prices scenarios are 25%, 50% and 25% for first, second and third scenario respectively, while consumption scenarios all have the value equal to 33%. In addition to consumption from scenarios there is also constant consumption of electrical energy which is the same for every scenario.

Recourse stage uses realized market prices (RP). In this case study three different arrays of realized prices will be analyzed. For convenience sake, they have been randomized in a way so that they follow normal daily price curve and can be seen in fig. 5. It is fair to assume that consumption will stay in bounds of predicted scenarios, since production is scheduled beforehand. Since, there are three different consumption scenarios and three different realization prices, model will have nine different realizations in recourse stage.

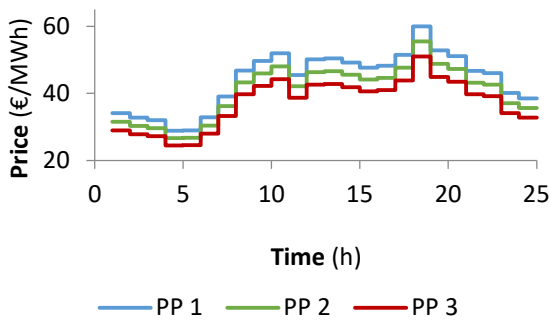

Fig. 4. Prediction of prices of electricity

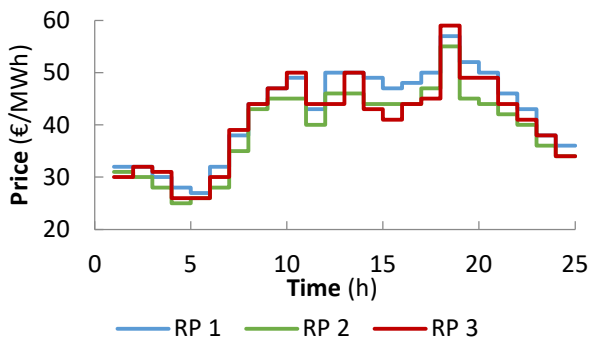

Fig. 5. Realized prices of electricity

B. Results

First stage of optimization decides on volumes that needs to be bought from day-ahead markets. Volumes of electrical energy are shown in fig. 6 and volume of gas is equal to 1.194,99 MWh.

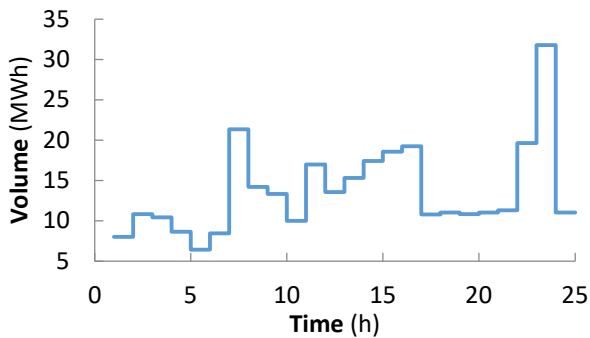

Fig. 6. Volumes of electricity bought from day-ahead market

Average cost in second stage is equal to 54061.45 €. Second stage mostly prefer to use gas motors instead of electric motors and turbines instead of letdown valves. On the other hand, boilers usage varies a lot throughout scenarios. It is also keener on satisfying higher consumption scenarios while planning to sell surplus electricity on balancing market in lower consumption scenarios. Figure 7 shows total cost in recourse stage for all models while fig. 8 shows percentage savings between models. As it can be seen, STMILP outperforms EMM and BaU. When compared to EMM, STMILP achieves maximum of almost 17% savings and

minimum of 2% while averaging a bit below 10% and if we compare it to BaU it achieves a maximum of 16% and a minimum of 11,5% with the average of almost 14%.

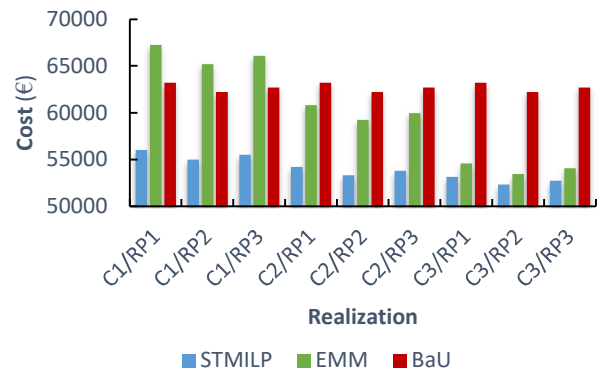

Fig. 7. Total cost in recourse stage

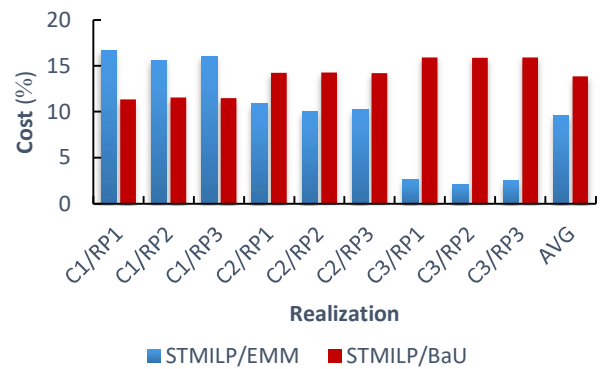

Fig. 8. Total and average savings

In higher consumption scenarios stochastics play greater role. There EMM and BaU struggles because they did not buy enough gas so they must replace it with electricity from intraday market. In lower consumption scenarios losses are dominant. Here EMM and BaU have enough, or close to enough gas, and surplus of electricity. This is the reason why EMM nearly approaches STMILP in C3 realizations. Another thing to consider is deviation of cost between realizations which show how models are affected by realizations. STMILP and BaU have low deviation, while EMM has very high deviation. STMILP has low deviation because of stochastic first stage and BaU because it does not have any flexibility to improve. EMM have some flexibility but not enough to compensate in high consumption scenarios. Average saving of EMM as oppose to BaU is 4%. Figure 9 shows production of electricity on first turbine in STMILP and EMM for scenario RP2 and all three C scenarios. In EMM scenarios C2 and C3, generator on turbine 1 is not using its full potential. In C1 plant has higher demand for heat that there is available gas for boilers so it must start electric motors instead of gas motors to free it up and buy electricity from balancing market. In accordance with higher electric load, turbines have higher production of electricity. In C2 there isn't enough gas to cover losses, so plant is minimizing it by starting boiler 3 which bypasses turbine 2, thus lowering its production. Similar case, but to a lower extent, is in C3.

IV. CONCLUSION

This paper attempts to demonstrate how energy-intensive industrial plants can achieve significant savings through linear optimization under uncertainty. The transition of the power system from monopolistic to market opened new doors for participation of active end users. Upgrading upon previous models, from deterministic to stochastic and from mass flow to energy flow, we were able to make realistic model of industrial plant. Optimizing with different consumption scenarios helps to lower deviation penalties. On the other hand, forecasting day-ahead prices of electricity is used to find favorable position on markets. Both items are assisted by plants inner flexibility and switching between different energy vectors to balance itself towards the grid. It

is also shown how one must be careful when using linear optimization as it can be sensitive when incorrect data is inputted, especially with consumption scenarios. If real consumption deviates too much from predicted, it can produce significant rise in cost. The same is true for price scenarios but to a lesser degree. EMM shows improper way of using optimization. Though, it manages to reduce cost in some cases, it also falls flat if unfavorable conditions happen. BaU was shown as a passive approach of dealing with markets and it had highest cost of the three. Future work will focus on more detail scenario and demand response modeling. The combination of the two directions could bring additional benefits to the consumer but it could also pose as additional computational burden and must be wisely designed.

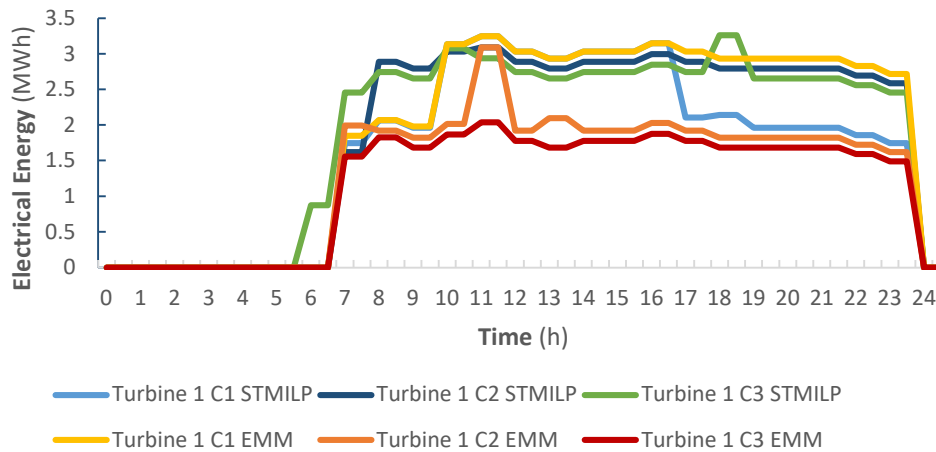

Fig. 9. Turbine production

ACKNOWLEDGMENT

The work is supported by Croatian Science Foundation (HRZZ) and Croatian Distribution System Operator (HEP ODS) under the project IMAGINE – Innovative Modelling and Laboratory Tested Solutions for Next Generation of Distribution Networks (PAR-2018-12)

REFERENCES

- [1] Y. K. Yeo, H. D. Roh, I. W. Kim, I. Moon, and Y. Chung, "Optimal operation of utility systems in petrochemical plants," *Korean J. Chem. Eng.*, vol. 20, no. 2, pp. 200–206, 2003.
- [2] E. G. de Magalhães, T. Fronza, K. Wada, and A. R. Secchi, "Steam and Power Optimization in a Petrochemical Industry," *IFAC Proc. Vol.*, vol. 39, no. 2, pp. 839–844, 2006.
- [3] W. Dai, Y. Liu, and X. Yang, "Optimal operational planning of utility systems of petrochemical industry," *Adv. Mater. Res.*, 2013.
- [4] C. W. Hui and Y. Natori, "An industrial application using mixed-integer programming technique: A multi-period utility system model," *Comput. Chem. Eng.*, vol. 20, no. SUPPL.2, 1996.
- [5] S. Mitra, L. Sun, and I. E. Grossmann, "Optimal scheduling of industrial combined heat and power plants under time-sensitive electricity prices," *Energy*, vol. 54, pp. 194–211, 2013.
- [6] X. Luo, B. Zhang, Y. Chen, and S. Mo, "Operational planning optimization of multiple interconnected steam power plants considering environmental costs," *Energy*, vol. 37, 2012.
- [7] S. Karagiannopoulos, E. Vrettos, G. Andersson, and M. Zima, "Scheduling and real-time control of flexible loads and storage in electricity markets under uncertainty," *Int. Conf. Eur. Energy Mark. EEM*, 2014.
- [8] E. A. M. Cesena, E. Loukarakis, N. Good, and P. Mancarella, "Integrated Electricity-Heat-Gas Systems: Techno-Economic Modeling, Optimization, and Application to Multienergy Districts," *Proc. IEEE*, pp. 1–19, 2020.
- [9] G. Chicco, S. Riaz, A. Mazza, and P. Mancarella, "Flexibility From Distributed Multienergy Systems," *Proc. IEEE*, 2020.
- [10] A. J. Conejo, M. Carrión, and J. M. Morales, *Decision Making under Uncertainty in Electricity Markets*. 2010.
- [11] M. Rudberg, M. Waldemarsson, and H. Lidestam, "Strategic perspectives on energy management: A case study in the process industry," *Appl. Energy*, vol. 104, pp. 487–496, 2013.
- [12] M. Sabet, "Industrial steam systems - Fundamentals and best design practices," p. 213, 2016.
- [13] U. Environmental Protection Agency, C. Heat, and P. Partnership, "Catalog of CHP Technologies, Section 4. Technology Characterization – Steam Turbines," 2015.
- [14] J. Kumana, "Thermodynamic Analysis of Steam Turbines for Industrial," no. July, 2017.
- [15] N. P. Padhy, "Unit Commitment—A Bibliographical Survey," 2004.
- [16] "Gurobi." [Online]. Available: <https://www.gurobi.com/>.
- [17] "CROATIAN ENERGY EXCHANGE - cropex.hr." [Online]. Available: <https://www.cropex.hr/en/>.

Optimal Cooperative Scheduling of Multi-Energy Microgrids Under Uncertainty

Matija Kostelac, Lin Herenčić, Tomislav Capuder

Department of Energy and Power Systems, Faculty of Electrical Engineering and Computing, University of Zagreb
Zagreb, Croatia
matija.kostelac@fer.hr

Abstract—With the restructuring of the power system, household level end-users are becoming active participants in the electricity market. Since their size is negligible versus the size of the whole system, they are encouraged to group into energy communities such as microgrids (MG). They operate parallel to the rest of the system and their operation is driven by market signals with the goal of minimizing energy costs for MG stakeholders by utilizing available resources in their portfolio. The complexity of optimizing MG operation increases with the introduction of additional energy vectors and their interaction with the electricity sector, but also with the possibility to provide services on multiple markets and on different time horizons. In the paper we consider different decarbonization strategies of several MGs, modelling 3 main cases: full electrification, gas-heat-electricity and electricity-hydrogen coupling. While each of these options can separately achieve savings, cooperation between different MGs can bring additional benefits for all involved parties. To evaluate these benefits we propose a stochastic two-stage mixed integer linear model for multi MG cooperation and bring the conclusions on the value of their joint market participation through several exchange scenarios. This is expressed through operational costs savings on annual and daily basis as well as through other metrics such as self sufficiency and CO2 savings.

Index Terms—microgrid, stochastic optimization, cooperation, multi-energy

NOMENCLATURE

Indices and Variables

Ψ, ψ	Set and index for scenarios
M, m	Set and index for microgrids
T, t	Set and index for hours
$b_{\psi, m, t}$	Boiler input power in scenario ψ , MG m and time t
$p_{\psi, m, t}$	PtH input power in scenario ψ , MG m and time t
$c_{\psi, m, t}$	CHP input power in scenario ψ , MG m and time t
$h_{\psi, m, t}$	FC input power in scenario ψ , MG m and time t
$\nu_{\psi, m, t}$	HP input power in scenario ψ , MG m and time t
$r_{\psi, m, t}$	Room temperature in scenario ψ , MG m and time t
$\Delta r_{\psi, m, t}$	Room temperature deviation in scenario ψ , MG m and time t
$f_{\psi, m, t}$	Floor temperature in scenario ψ , MG m and time t
$w_{\psi, m, t}$	Water temperature in scenario ψ , MG m and time t
$d_{\psi, m, t}$	Heat demand in scenario ψ , MG m and time t
$\alpha_{\psi, m, t}$	Input power of heat storage in scenario ψ , MG m and time t
$\underline{\alpha}_{\psi, m, t}$	Output power of heat storage in scenario ψ , MG m and time t

$\bar{\beta}_{\psi, m, t}$	Input power of battery storage in scenario ψ , MG m and time t
$\beta_{\psi, m, t}$	Output power of battery storage in scenario ψ , MG m and time t
$\bar{\gamma}_{\psi, m, t}$	Input power of hydrogen storage in scenario ψ , MG m and time t
$\underline{\gamma}_{\psi, m, t}$	Output power of hydrogen storage in scenario ψ , MG m and time t
ω_m	Volume of gas bought from day-ahead market in MG m
$\bar{\epsilon}_{m, t}$	Volume of electricity bought from day-ahead market in MG m and time t
$\underline{\epsilon}_{m, t}$	Volume of electricity sold to day-ahead market in MG m and time t
$\bar{\rho}_{\psi, m, t}$	Volume of electricity bought from local MG market in scenario ψ , MG m and time t
$\underline{\rho}_{\psi, m, t}$	Volume of electricity sold to local MG market in scenario ψ , MG m and time t

Parameters

η^b	Efficiency coefficient for boiler
η^p	Efficiency coefficient for PtH
$\eta^{c, el}$	Efficiency coefficient for CHP electricity output
$\eta^{c, heat}$	Efficiency coefficient for CHP heat output
$\eta^{h, el}$	Efficiency coefficient for FC electricity output
$\eta^{h, heat}$	Efficiency coefficient for FC heat output
COP	Coefficient of performance for HP
$A_{m, t}$	Ambient temperature of MG m and time t
R^{max}	Room temperature upper bound
R^{min}	Room temperature lower bound
W^{max}	Water temperature upper bound
N_m	Number of household in MG m
$L_{\psi, m, t}$	Household load in scenario ψ , MG m and time t
$PV_{\psi, m, t}$	PV production in scenario ψ , MG m and time t
$\pi_{\psi, m, t}$	Price of electricity in scenario ψ , MG m and time t
G	Gas price
λ_{ψ}	Probability of scenario ψ
μ	Penalty for temperature deviation
τ	Transmission system cost
γ	Distribution system cost

I. INTRODUCTION

A. Motivation and Background

Renewable energy sources (RES) connected to low or medium voltage distribution grid are taking the lead in de-

carbonization of the power systems and, by coordinating their operation with local controllable assets, unlocks new flexibility options on the side of end-users [1]. This can be further increased when energy vectors, such as electricity, gas and hydrogen, are coupled and operate in an integrated way. In general, multi energy systems (MESs) incorporate different energy vectors so that they function together and complement each other through shifting and virtually storing energy in different energy forms [2]. MES flexibility can be exercised through demand response (DR), battery energy storage systems (BESSs), combined heat and power unit (CHP), heat pumps (HP), power-to-hydrogen (P2H), and can have the scale of local end-users [3], district level clustered options such as MGs [4], virtual power plants [5] or energy communities at the city or national scale.

Microgrid is a cluster of distributed energy sources, energy storage systems, and controllable and uncontrollable loads, presented as a single entity towards the grid. They can operate parallel to the grid, but can also function autonomously in island mode [6]. The goal of the MG operation is to provide the most benefits to its stakeholders through security of supply, better resource management and lower operation cost. The rule of thumb says that the more flexibility the MG possess the better it will be in achieving previously mentioned goals. Ideally MG would have a device suitable for any occasion that appears on the market and incorporates a wide variety of different energy vectors. Realistically, devices are chosen based on their investment costs, rate of return, MG operator or stakeholders preferences, etc. In other words MG will contain a set of devices, e.g. photovoltaic system (PV), BSS and HP. This example might be sensitive to electricity prices or BSS capacity during low PV production periods (e.g. in winter months). Collaboration of that MG with other MGs which have alternative ways of producing electricity (e.g. CHP plant) could be beneficial. A group of such MGs cooperating together can greatly increase their overall flexibility and reduce sensitivity on market changes and unfavourable periods. The general concept of MES MG cooperation is shown in fig. 1 where three MGs cooperate together on local MG market and also jointly participate in a global power exchange. Square shapes represent energy conversion devices and tank shapes present storage units, while flow of energy is defined with colored lines: blue for electricity, orange for gas, yellow for heat, grey for hydrogen and red for local MG market. The developed MES MG operational model considers the uncertainty in RES production, MG consumption and electricity prices. Imperfections in predictions of production and consumption can lead to mismatch of import/export of electricity which may lead to penalties. Electricity price predictions are used for positioning MG on electricity day-ahead market. Cooperation of different MGs will thus lead to a reduction in the risk of uncertainty. For real-world operational and market implementations the modelling aspect would be adjusted to capture realistic aspects of critical information privacy and/or different entity ownerships. The following Section provides a systematic literature review and detects gaps in the current

research body. It ends with a proposal of contributions that address the identified issues.

B. Relevant Literature

Cooperation of multiple different MGs in an uncertain environment (electricity market, RES production and energy consumption) has been a topic of interest, however there are still gaps in the literature, especially in terms of MES MGs and interaction of different energy vectors. Reference [7] proposes a chance-constrained optimization model of MG cluster. Four different trading models are presented for 16 MGs with same architecture but varying in size. Uncertainty parameters considered are electricity prices and PV production. A case of multi MG coordination is shown in [8] with multiple objectives of cost minimization and independence from grid maximization. It incorporates RES production as a stochastic parameter, but does not incorporate other energy vectors besides electricity. Free energy trading multi MG approach, where every MG achieves same percentage of cost savings is presented in [9]. MGs are only considered to have electricity production from PV and wind to achieve 100% renewable production. The model is created as a hybrid version of IGDT (Info-gap decision theory) and stochastic programming with RES production as stochastic parameter. In [10] the authors present a local competitive peer-to-peer market for energy trading (electricity, heat, cooling) of multi-carrier energy hubs. Each energy hub separately optimizes its day-ahead schedule and then they compete on the local energy market. In the day-ahead scheduling, energy hubs consider uncertainty in price, generation and demand. A different approach is used in [11] where multi-energy retailer competes in various energy markets with the goal of selling energy bilaterally to consumers. This approach transfers market risk from consumer to the retailer. The retailer uses a hybrid robust-stochastic approach for dealing with electricity price and consumption uncertainty. Lyapunov optimization approach for energy trading of multi-energy MGs is presented in [12]. Energy trading is designed as double-auction mechanism where MG submits purchase/selling prices and volumes to external auctioneer, who then by trading rules decide the accepted prices and allocates energy to MGs.

Multi-energy systems are fairly researched area through different concepts and model, from methods for sizing and resource planning of MES [13] to energy management and flexibility potential [14]. Reference [15] provides detailed overview of MES concepts from various perspectives and with different evaluation methods. Techno-economic analysis on flexibility of MES considering investment cost and environmental benefits is presented in [16]. Framework and benefits of MES as an ancillary service provider are explored in [17]. Numerous other papers deal with optimal unit sizing and energy management of MG [18], [19] or dynamics of MG [20].

C. Contributions and Organization

Most of the literature consider very similar MGs in their research thus failing to show importance of different energy

vectors. Also, they fail to emphasise benefits of MG cooperation in risk reduction from uncertainty. Thus the contributions proposed in this paper are summarised as follows:

- Define the benefits of multiple multi-energy microgrids cooperation based on optimization of joint market participation as compared to the individual case. The model will incorporate mutual trading under local price signals but also will discuss benefits of mutual energy exchange with no charges.
- The paper develops a two-stage stochastic mixed integer linear optimization model for day-ahead and real-time scheduling of multiple microgrids where the interplay of different multi-energy microgrids is enabled and compared to individual market performance.

Rest of the paper is organized as follows: Model formulation is presented in section II; case study description in section III; results are presented in section IV; and section V concludes the paper.

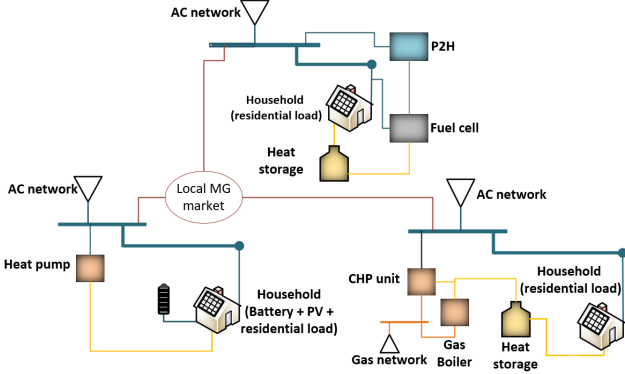

Fig. 1. Layout of proposed multi-energy MGs

II. MODEL FORMULATION

In this chapter the proposed model for multi MG cooperation will be explained. It is cast as a two-stage stochastic mixed integer linear model. Uncertainty in stochastic optimization is presented through scenarios (ψ) and their probability of occurrence (λ_ψ). The optimization is done in two stages. In the first stage a decision must be made before the realization of uncertainty and in the second stage we optimize MGs behaviour after the realization of uncertainty but considering first stage decisions. Each stage has its own set of variables. All equations are valid for each scenario, MG and hour unless stated otherwise.

A. Mathematical model

The goal of the optimization is to reduce the expected operational costs considering uncertainty scenarios. The objective function is shown in (1) as a weighted (λ_ψ) sum of electricity and gas bought/sold from/to the day ahead market, energy exchanged between MGs, CHP and boiler start up cost and penalty for temperature deviation.

$$\sum_{j=1}^{\Psi} \sum_{i=1}^T (\bar{\epsilon}_{m,i} \cdot (\pi_{j,m,i} + \tau + \gamma) \cdot \lambda_j - \underline{\epsilon}_{m,i} \cdot \pi_{j,m,i} \cdot \lambda_j + \bar{\rho}_{j,m,i} \cdot (\pi_{j,m,i} + \gamma) \cdot \lambda_j - \underline{\rho}_{j,m,i} \cdot \pi_{j,m,i} \cdot \lambda_j + \Delta r_{j,m,i} \cdot \mu \cdot \lambda_j + Start_{j,m,i} \cdot \lambda_j) + \omega_m \quad (1)$$

Each MG contains a specific set of devices which is defined prior to the optimisation. If the device is present in the current MG the belonging constrains and variables are included in the specific MG model. Most of the devices are constrained with the minimum and maximum input power as shown in (2), including: heat pump (HP), combined heat and power unit (CHP), boiler, power to hydrogen unit (PtH) and fuel cell (FC). In (2) "var" represents a continuous variable of production/consumption for a specific device and "Xvar" represents a binary variable which indicates if the device is online. The boiler and the CHP are modelled with the start up cost, so they need extra binary variables and constrains (3), which set binary variable to "1" if the device is started. The relation between device's input and output depends on a device. Output of devices such as boiler and PtH is reduced depending on its efficiency as shown in (4) and (5). Superscript "O" denotes output variable. Please note that these output variables are virtual i.e. they are not used in optimisation, instead corresponding expressions (4)-(8) are used to reduce the number of variables. CHP and FC have two different outputs: electricity and heat. Their outputs are calculated using electrical and heat efficiency as shown in (6) and (7). HP uses coefficient of performance to calculate output power shown in (8).

$$\min \cdot Xvar_{\psi,m,t} \leq var_{\psi,m,t} \leq \max \cdot Xvar_{\psi,m,t} \quad (2)$$

$$Xvar_{\psi,m,t} - Xvar_{\psi,m,t-1} \leq start_{\psi,m,t} \quad (3)$$

$$b_{\psi,m,t}^O = \eta^b \cdot b_{\psi,m,t} \quad (4)$$

$$p_{\psi,m,t}^O = \eta^p \cdot p_{\psi,m,t} \quad (5)$$

$$c_{\psi,m,t}^{O,el} = \eta^{c,el} \cdot c_{\psi,m,t}, \quad c_{\psi,m,t}^{O,heat} = \eta^{c,heat} \cdot c_{\psi,m,t} \quad (6)$$

$$h_{\psi,m,t}^{O,el} = \eta^{h,el} \cdot h_{\psi,m,t}, \quad h_{\psi,m,t}^{O,heat} = \eta^{h,heat} \cdot h_{\psi,m,t} \quad (7)$$

$$\nu_{\psi,m,t}^O = COP \cdot \nu_{\psi,m,t} \quad (8)$$

We model different types of storage by following the same logic where all are modeled in the same way. There are three types of storage that MGs can have: battery storage system, heat storage and hydrogen storage. Each storage has to keep track of the amount of energy stored (SOE) shown in (9). Variables "in" and "out" correspond to input and output amounts to the storage and " η^{in} " and " η^{out} " are efficiencies. Variables that are used for input and output amounts, as well as for state of storage use equation (2) to constrain their bounds, with the exception that the state of storage does not need binary variables. Initial value of SoS is predefined and set in the hour "0" and SoS in the last hour must be greater or equal than initial state.

$$SOE_{\psi,m,t} = SOE_{\psi,m,t-1} + in_{\psi,m,t} \cdot \eta^{in} - \frac{out_{\psi,m,t}}{\eta^{out}} \quad (9)$$

Microgrids will also employ energy storage in form of smart household heating. Model calculates various temperatures in a house, a keeps them within the predefined threshold. This approach enables load shifting of heating units while maintaining the end-user comfort. It is based on the heat capacity and heat transfer coefficients between room air, floor, heating water and ambient based on its temperature. Equation (10)

calculates the room temperature of the building based on its previous state, floor and ambient temperature. Similarly (11) calculates the floor temperature from its previous state, room and water temperature and (12) calculates water temperature from its previous state, floor temperature and heat input. Equations (13) and (14) keep the room temperature between certain predefined thresholds. The variable $\Delta r_{\psi,m,t}$ is used for deviation of the temperature from this threshold in order to increase the model feasibility, but it is severely penalized in the objective function. The water temperature also has an upper bound, which is constrained with (15). Initial values for temperatures are predefined and set in hour "0". Also, we consider that water temperature in the last hour must at least be the same as the initial value. This model is a slight adaptation of models taken from [21] and [22]. These referenced model considers only one device for heating which is incorporated in equation (12). Instead our model is expanded by introducing the heat input variable ($d_{\psi,m,t}$) which can be produced by a variety of different devices/units within the MG.

$$r_{\psi,m,t} = a_{11} r_{\psi,m,t-1} + a_{12} f_{\psi,m,t-1} + e A_{m,t} \quad (10)$$

$$f_{\psi,m,t} = a_{21} r_{\psi,m,t-1} + a_{22} f_{\psi,m,t-1} + a_{23} w_{\psi,m,t-1} \quad (11)$$

$$w_{\psi,m,t} = a_{32} f_{\psi,m,t-1} + a_{33} w_{\psi,m,t-1} + D d_{\psi,m,t-1} \quad (12)$$

$$r_{\psi,m,t} - \Delta r_{\psi,m,t} \leq R^{max} \quad (13)$$

$$r_{\psi,m,t} + \Delta r_{\psi,m,t} \geq R^{min} \quad (14)$$

$$w_{\psi,m,t} \leq W^{max} \quad (15)$$

After the devices have been defined, they need to be interconnected. Each MG can be composed of one or more different energy types: electricity, gas, heat and hydrogen. For each of these, a balancing constrain will be used. In case the energy vector or a certain device is not present in the modelled MG, equations or variables associated with it will be omitted. Equation (16) is a heat demand balance equation. Some devices are specific for a certain household, like HP, while others are centralised for the entire MG. Devices that are in each house have their value multiplied by the number of households. Hydrogen that is produced must either be stored or consumed as written in (17). Gas is bought from a day ahead market in a single 24 hour bid as shown in (18). Lastly, (19) is the balance equation for each hour. Variables for gas bid " ω_m " and electricity bids " $\bar{\epsilon}_{m,t}$ " and " $\underline{\epsilon}_{m,t}$ ", are first stage decisions variables and as such must be valid in each scenario. All other variables are second stage variables and are different in all scenarios. Trading between MGs is implemented using (20), where variable $\bar{\rho}_{\psi,m,t}$ is used if MGs buy electricity from each other and $\underline{\rho}_{\psi,m,t}$ if they sell electricity to each other. Trading is implemented so that the purchased volumes are equal to the sold volumes.

$$N_m \cdot d_{\psi,m,t} = N_m \cdot \nu_{\psi,m,t}^O - \bar{\alpha}_{\psi,m,t} + \underline{\alpha}_{\psi,m,t} + c_{\psi,m,t}^{O,heat} + b_{\psi,m,t}^O + h_{\psi,m,t}^{O,heat} \quad (16)$$

$$p_{\psi,m,t}^O - \bar{\gamma}_{\psi,m,t} + \underline{\gamma}_{\psi,m,t} - h_{\psi,m,t} = 0 \quad (17)$$

$$\omega_m = \sum_{i=1}^T (c_{\psi,m,i} + b_{\psi,m,i}) \quad (18)$$

$$N_m \cdot L_{\psi,m,t} = N_m \cdot PV_{\psi,m,t} - N_m \cdot \bar{\beta}_{\psi,m,t} + N_m \cdot \underline{\beta}_{\psi,m,t} - N_m \cdot \nu_{\psi,m,t} + c_{\psi,m,t}^{O,el} - p_{\psi,m,t} + h_{\psi,m,t}^{O,el} + \bar{\epsilon}_{m,t} - \underline{\epsilon}_{m,t} + \bar{\rho}_{\psi,m,t} - \underline{\rho}_{\psi,m,t} \quad (19)$$

$$\sum_{j=1}^M \bar{\rho}_{\psi,j,t} = \sum_{j=1}^M \underline{\rho}_{\psi,j,t} \quad (20)$$

III. CASE STUDY

The case study will incorporate three different MGs shown in Fig. 1:

- The first MG will be fully electrified with heat pumps, battery storage systems and photovoltaics in every household.
- The second MG will use gas devices such as CHP unit and boiler in combination with heat storage. Each household will possess a photovoltaic unit.
- The third MG is hydrogen based with PtH electrolyzer, hydrogen storage and FC. Each household will possess a photovoltaic unit.

Gas and hydrogen devices are centralised which means there is only one of each in a MG. Rated power of each PV unit in every household is 2 kW and will have 30 households. Each battery has charging and discharging power of 1 kW and the capacity of 5 kWh, with charging and discharging efficiency of 0.9. HPs have input power of 4 kW and a COP of 2.5. Input power of the central CHP unit is 450 kW with electric efficiency of 22% and heating efficiency of 70%. Backup boiler to that CHP has input power of 360 kW and the efficiency of 85%. Heat storage can store up to 100 kWh with input and output power of 50 kW and efficiency of 90%. PtH is based on alkaline water electrolysis with input power of 152 kW and efficiency of 66%. Central FC has a rated power of 600 kW with electric efficiency of 37% and heating efficiency of 52%. Hydrogen storage can store up to 1200 kWh with input and output power of 600 kW and efficiency of 90%. Devices that produce heating energy are sized so that they have around 10 kW of thermal output per household. Specific emissions of electricity from grid is 0.177 kg/kWh and for gas is 0.202 kg/kWh. Sizing of devices and other mentioned parameters are taken from [23]. Room temperature must be kept between 19 °C and 24.7 °C based on research from [21] and water temperature must not surpass 80 °C. Penalty for deviation of room temperature is 30 €/°C. Three different ambient temperatures (one for each MG) are taken for winter day in Mediterranean Croatia. Gas price is not volatile as electricity price so it will be used as deterministic value and is equal to 28 €/MWh according to statistics from [24] for Croatia.

Stochastic parameters used in the model are: PV production, day-ahead electricity price and electrical demand of the households. Nine scenarios are used in stochastic optimization with different parameters arrays. Three arrays of values of each stochastic parameters were generated for each MG and then combined in nine different scenarios, considering equal probability of occurrence. The day-ahead electricity prices are

predicted using SARIMA (seasonal autoregressive integrated moving average) model for Croatian power exchange [25] from which price scenarios are created. The final cost of MG buying electricity also includes transmission and distribution network fees/tariffs which are set as fixed values. When MGs are trading between themselves only the distribution network fee is paid and when the MGs sell electricity either to electricity market or between themselves they earn day-ahead price. Electricity load profiles are generated using [26] and PV production profiles using [27].

To analyse benefits of MG cooperation, five cases will be examined:

- MGC - three different MGs with trading between MGs enabled.
- TM - three different MGs with trading between MGs disabled (variables $\bar{\rho}_{\psi,m,t}$, $\rho_{\psi,m,t}$ and constrain (20) are removed).
- EE - three fully electric MGs with trading between MGs enabled.
- Gas - three gas MGs with trading between MGs enabled.
- H2 - three hydrogen MGs with trading between MGs enabled.

IV. RESULTS

The model is written in Python 3.8 and solved using Gurobi 9 optimization solver [28]. PC specifications are AMD Ryzen 5 3600 6-Core 3.59 GHz processor and 16 GB of RAM. Computational time is of the order of 10 seconds.

Table I shows the values of the objective functions for the MG cooperation model (MGC), the testing model (TM) and for the cases with same MG types per MG. The savings are expressed with regards to the MGC model. The total cost of MGC is around 4.4% better than the TM on a daily basis, meaning this is the value of intra MG trading option. Interestingly, although the overall costs are lower, the third MG has higher cost in the MGC model than in the TM model. This comes as a result of how the optimization is set; it is trying to lower the overall cost of the MGs and not their individual costs. To even this out and provide incentives for each of the MGs to participate in the trading arrangements, the central entity optimizing all MGs would need to incorporate a cost sharing mechanism similar to [29]; this is outside of the scope of this paper. Fig. 2 presents accumulated electricity trade in the day ahead market for all cases. Total gas volumes bought are 15.5 kWh for MGC, 590 kWh for TM and 2273 kWh for gas case. In addition to cost saving, MGC also lowered total energy import by 22%. Decreases in import means that MGs in MGC are more self-sufficient, because they are less dependant on external sources of energy. In terms of CO_2 emissions MGC managed to have 25% lower emissions than TM. Trade between MGs is mainly used to lower uncertainty risk, which can be seen from fig. 3. There is significant change in trade between scenarios as the MGs are trying to adjust their operation based on their day-ahead schedule decision and realization of a certain scenario.

Although MGC shows better results than the TM, the value of multi-energy cooperation is not shown when comparing

TABLE I
VALUE OF OBJECTIVE FUNCTION FOR ALL EXAMINED CASES

MG	MGC	TM	EE	Gas	H2
1	32.93	33.51	32.79	43.95	34.17
2	43.44	53.9	47.69	54.87	48.27
3	51.28	46.06	38.71	49.29	46.39
Total	127.65	133.46	119.19	148.1	128.83
Savings		4.35%	-7.1%	13.8%	0.91%

TABLE II
PERCENTAGE DIFFERENCE BETWEEN MGC AND EE, GAS, H2 BASED ON PRICE INCREASES

Price Multiplier	EE	Gas	H2
1.25	-6.83%	8.23%	1.03%
1.5	-6.69%	5.56%	1.1%
2	-4.89%	0.42%	2.64%

with the case of three EE MG, which have 7% lower cost than the MGC. The explanation is rather simple as: i) the price of electricity is low; ii) the EE has the most efficient and most flexible electricity storage system and iii) heat pump is, most of the time, the cheapest heat producer. The H2 case is very similar to MGC, being only being 1% worse. The cost is higher in H2 case because the roundtrip efficiency for storing electricity as hydrogen is much lower than that of the battery storage system and because electricity production of fuel cell is dependant on heat consumption. The worst case is Gas being almost 14% more expensive than MGC and is even more expensive than TM. Gas case lacks flexibility because electricity production of CHP and its heat storage are highly dependant on heat consumption. Lack of flexibility is somewhat mitigated with high amount of local electricity trading seen in fig. 3. EE and H2 cases need the least amount of flexibility from local energy trading, but still utilize it for the purpose of mitigating risk from uncertainty. Investment cost analysis could improve results shown in this chapter, but was not part of this paper.

Last analysis will show how are saving between MGC and EE, Gas and H2 effected by price increase. Electricity prices are increased by 25%, 50% and 100% as shown in first column of table II. EE and H2 cases sees their percentage difference increased from the original case. Gas case becomes more competitive as the electricity price rises, being very similar to MGC at 100% multiplier.

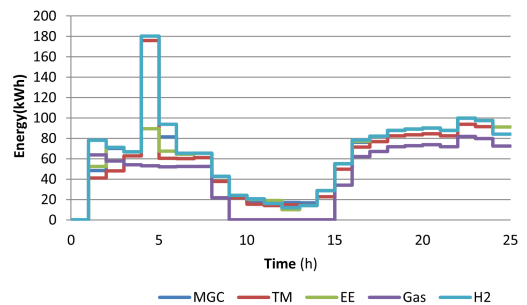

Fig. 2. DAM bid in all cases (MGC, TM, EE, Gas, H2)

V. CONCLUSION

The goal of this paper was to show how multiple different microgrids can cooperate together. Three different microgrids

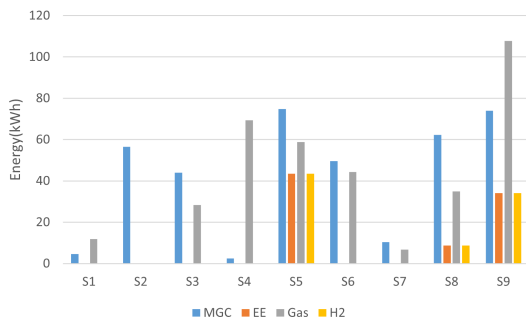

Fig. 3. Trade between MGs in all cases (MGC, EE, Gas, H2) and scenarios

are created: fully electrified, gas based and hydrogen based. Trading between microgrids is done in a way so neither participant is at a loss. Additionally, competing in a day-ahead electricity market is considered. The uncertainties are modeled through two-stage stochastic optimization, capturing day-ahead electricity price, electricity load and PV production. The cooperation model utilizing local energy trading was found to be 4.3% better than a model without cooperation and it also improved self sufficiency of MGs by lowering import volumes by 22% and CO_2 emissions by 25%. The case with three electric MGs was found to be better than case where all MGs were different, case with three hydrogen MGs was slightly worst and case with three gas MGs had the worst performance. The local energy trading was mostly used by the models to mitigate risk of uncertainty and to better adjust operation of MGs.

ACKNOWLEDGMENT

The work is supported by Croatian Science Foundation (HRZZ) and Croatian Distribution System Operator (HEP ODS) under the project IMAGINE – Innovative Modelling and Laboratory Tested Solutions for Next Generation of Distribution Networks (PAR-2018-12), and supported in part by Croatian Science Foundation under the project IMPACT – Implementation of Peer-to-Peer Advanced Concept for Electricity Trading (grant No. UIP-2017-05-4068).

REFERENCES

- [1] I. Pavić, M. Beus, H. Pandžić, T. Capuder, and I. Štritof, "Electricity markets overview — market participation possibilities for renewable and distributed energy resources," in *2017 14th International Conference on the European Energy Market (EEM)*, 2017, pp. 1–5.
- [2] P. Mancarella and G. Chicco, "Real-time demand response from energy shifting in distributed multi-generation," *IEEE Transactions on Smart Grid*, vol. 4, no. 4, pp. 1928–1938, 2013.
- [3] N. Good, E. Karangelos, A. Navarro-Espinosa, and P. Mancarella, "Optimization under uncertainty of thermal storage-based flexible demand response with quantification of residential users' discomfort," *IEEE Transactions on Smart Grid*, vol. 6, no. 5, pp. 2333–2342, 2015.
- [4] N. Holjevac, T. Capuder, N. Zhang, I. Kuzle, and C. Kang, "Corrective receding horizon scheduling of flexible distributed multi-energy microgrids," *Applied Energy*, vol. 207, pp. 176 – 194, 2017, transformative Innovations for a Sustainable Future – Part II.
- [5] T. Capuder and P. Mancarella, "Assessing the benefits of coordinated operation of aggregated distributed multi-energy generation," in *2016 Power Systems Computation Conference (PSCC)*, 2016, pp. 1–7.
- [6] A. Hirsch, Y. Parag, and J. Guerrero, "Microgrids: A review of technologies, key drivers, and outstanding issues," *Renewable and Sustainable Energy Reviews*, vol. 90, pp. 402–411, 2018.
- [7] M. Daneshvar, B. Mohammadi-Ivatloo, S. Asadi, A. Anvari-Moghaddam, M. Rasouli, M. Abapour, and G. B. Gharehpetian, "Chance-constrained models for transactive energy management of interconnected microgrid clusters," *Journal of Cleaner Production*, vol. 271, p. 122177, 2020.
- [8] H. Karimi and S. Jadid, "Optimal energy management for multi-microgrid considering demand response programs: A stochastic multi-objective framework," *Energy*, vol. 195, p. 116992, 2020.
- [9] M. Daneshvar, B. Mohammadi-ivatloo, K. Zare, S. Asadi, and A. Anvari-Moghaddam, "A novel operational model for interconnected microgrids participation in transactive energy market: A hybrid igdt/stochastic approach," *IEEE Transactions on Industrial Informatics*, pp. 1–1, 2020.
- [10] M. Khorasany, A. Najafi-Ghalelou, R. Razzaghi, and B. Mohammadi-ivatloo, "Transactive energy framework for optimal energy management of multi-carrier energy hubs under local electrical, thermal, and cooling market constraints," *International Journal of Electrical Power Energy Systems*, 01 2021.
- [11] M. Zare Oskouei, M. A. Mirzaei, B. Mohammadi-Ivatloo, M. Shafiee, M. Marzband, and A. Anvari-Moghaddam, "A hybrid robust-stochastic approach to evaluate the profit of a multi-energy retailer in tri-layer energy markets," *Energy*, vol. 214, p. 118948, 2021.
- [12] D. Zhu, B. Yang, Q. Liu, K. Ma, S. Zhu, and C. Ma, "Energy trading in microgrids for synergies among electricity, hydrogen and heat networks," *Applied Energy*, vol. 272, p. 115225, 08 2020.
- [13] J. Sachs and O. Sawodny, "Multi-objective three stage design optimization for island microgrids," *Applied Energy*, vol. 165, pp. 789 – 800, 2016.
- [14] A. Parisio, C. Del Vecchio, and A. Vaccaro, "A robust optimization approach to energy hub management," *International Journal of Electrical Power Energy Systems*, vol. 42, no. 1, pp. 98 – 104, 2012.
- [15] P. Mancarella, "Mes (multi-energy systems): An overview of concepts and evaluation models," *Energy*, vol. 65, pp. 1 – 17, 2014.
- [16] T. Capuder and P. Mancarella, "Techno-economic and environmental modelling and optimization of flexible distributed multi-generation options," *Energy*, vol. 71, pp. 516 – 533, 2014.
- [17] P. Mancarella, G. Chicco, and T. Capuder, "Arbitrage opportunities for distributed multi-energy systems in providing power system ancillary services," *Energy*, vol. 161, pp. 381 – 395, 2018.
- [18] N. Holjevac, T. Capuder, and I. Kuzle, "Defining key parameters of economic and environmentally efficient residential microgrid operation," *Energy Procedia*, vol. 105, pp. 999 – 1008, 2017.
- [19] C. Shilaja, T. Arunprasath, and P. Priya, "Day-ahead optimal scheduling of microgrid with adaptive grasshopper optimization algorithm," *International Journal of Communication Systems*, p. e4133, 2019.
- [20] A. Karimi, Y. Khayat, M. Naderi, T. Dragičević, R. Mirzaei, F. Blaabjerg, and H. Bevrani, "Inertia response improvement in ac microgrids: A fuzzy-based virtual synchronous generator control," *IEEE Trans. Power Electron.*, vol. 35, no. 4, pp. 4321–4331, 2020.
- [21] M. Zugno, J. Morales González, P. Pinson, and H. Madsen, "A bilevel model for electricity retailers' participation in a demand response market environment," *Energy Economics*, vol. 36, pp. 182–197, 2013.
- [22] R. Halvgaard, N. K. Poulsen, H. Madsen, and J. B. Jørgensen, "Economic model predictive control for building climate control in a smart grid," in *2012 IEEE PES Innovative Smart Grid Technologies (ISGT)*, 2012, pp. 1–6.
- [23] L. Herenčić, M. Melnjak, T. Capuder, I. Andročec, and I. Rajšl, "Techno-economic and environmental assessment of energy vectors in decarbonization of energy islands," *Energy Conversion and Management*, vol. 236, p. 114064, 2021.
- [24] "EU-28: industrial prices of natural gas 2019 — Statista."
- [25] "CROATIAN ENERGY EXCHANGE." [Online]. Available: <https://www.cropex.hr/en/>
- [26] N. Pflugrad, "Load profile generator v8.9," <https://www.loadprofilegenerator.de/>.
- [27] S. Pfenninger and I. Staffell, "Long-term patterns of european pv output using 30 years of validated hourly reanalysis and satellite data," *Energy*, vol. 114, pp. 1251–1265, 2016. [Online]. Available: <https://www.renewables.ninja/>
- [28] "Gurobi." [Online]. Available: <https://www.gurobi.com/>
- [29] M. Grzanić, J. M. Morales, S. Pineda, and T. Capuder, "Electricity cost-sharing in energy communities under dynamic pricing and uncertainty," *IEEE Access*, vol. 9, pp. 30 225–30 241, 2021.

Biography

Matija Kostelac was born in 1996 in Zagreb. He entered the Faculty of Electrical Engineering and Computing at the University of Zagreb in 2014 and graduated in 2019 on the Department of Energy and Power Systems. In the same year, he was employed as a research assistant at the Department of Energy and Power Systems at the Faculty of Electrical Engineering and Computing, University of Zagreb.

During his work as a research assistant, he participated in various domestic and international projects related to the field of power engineering, financed by the Croatian Science Foundation and the European Union. He also participated in making of several technical studies financed by the industry subjects. He participated in conduction of university classes on the subject of risk management.

While working at the university, he published 4 papers in the A category of journals, 5 papers at international conferences and 2 papers at domestic conferences. The field of research includes the integration of industrial plants into electricity markets. It also analyzes the possibility of reducing their greenhouse gas emissions by integrating renewable energy sources and hydrogen technologies.

He is a member of scientific and professional associations IEEE, IEEE PES and HO CIGRE.

A detailed list of works can be accessed:

- <https://scholar.google.com/citations?user=-D4FEUUAAAAJ&hl=en>
- <https://www.scopus.com/authid/detail.uri?authorId=57219535854>
- <https://www.webofscience.com/wos/author/record/24221112>

List of published and accepted papers

Journal papers

- [P₁] M. Kostelac, I. Pavić, N. Zhang, T. Capuder, "Uncertainty modelling of an industry facility as a multi-energy demand response provider," *Applied Energy*, Volume 307, 2022, 118215, ISSN 0306-2619, doi: 10.1016/j.apenergy.2021.118215
- [P₂] M. Kostelac, I. Pavić, T. Capuder, "Economic and environmental valuation of green hydrogen decarbonisation process for price responsive multi-energy industry prosumer,"

Applied Energy, Volume 347, 2023, 121484, ISSN 0306-2619,

doi: 10.1016/j.apenergy.2023.121484

- [P₃] M. Kostelac, L. Herenčić, and T. Capuder, "Planning and Operational Aspects of Individual and Clustered Multi-Energy Microgrid Options," *Energies*, vol. 15, no. 4, p. 1317, Feb. 2022, doi: 10.3390/en15041317
- [P₄] T. Capuder, B. Barać, M. Kostelac, and M. Krpan, "Three-Stage Modeling Framework for Analyzing Islanding Capabilities of Decarbonized Energy Communities," *Energies*, vol. 16, no. 11, p. 4321, May 2023, doi: 10.3390/en16114321

International conference papers

- [C₁] M. Kostelac, I. Pavić and T. Capuder, "Mathematical model of flexible multi-energy industrial prosumer under uncertainty," 2020 International Conference on Smart Energy Systems and Technologies (SEST), Istanbul, Turkey, 2020, pp. 1-6, doi: 10.1109/SEST48500.2020.9203240
- [C₂] T. Capuder, M. Kostelac, M. Krpan and I. Pavić, "Multi-energy Microgrid Ability to Provide Flexibility Services to the System Operator and Security of Supply to End-users," 2020 International Conference on Smart Energy Systems and Technologies (SEST), Istanbul, Turkey, 2020, pp. 1-6, doi: 10.1109/SEST48500.2020.9203390
- [C₃] M. Kostelac, L. Herenčić and T. Capuder, "Optimal Cooperative Scheduling of Multi-Energy Microgrids Under Uncertainty," 2021 International Conference on Smart Energy Systems and Technologies (SEST), Vaasa, Finland, 2021, pp. 1-6, doi: 10.1109/SEST50973.2021.9543123
- [C₄] B. Barać, M. Kostelac, I. Pavić, T. Capuder, J. Grašo, A. Marušić, T. Koledić, J. Bariščin, "Modelling and Evaluating Capability of Battery Storage Systems to Provide Extreme Event Services to the DSO: Case Study of Croatia," 2022 IEEE 21st Mediterranean Electrotechnical Conference (MELECON), Palermo, Italy, 2022, pp. 34-39, doi: 10.1109/MELECON53508.2022.9842864
- [C₅] M. Kostelac, B. Barać, I. Pavić, T. Capuder, J. Grašo, A. Marušić, T. Koledić, J. Bariščin, "Optimizing Battery Storage System for N-k Security Supply of Critical Medium Voltage Distribution Network Connected End-users : Case Study of Zagreb," in *Proceedings of 5th SEE SDEWES*, 2022, pp. 1–10.

Domestic conference papers

- [C₆] N. Čović, M. Kostelac, T. Capuder and H. Pandžić, "Predviđanje cijena na hrvatskom dan unaprijed tržištu električne energije korištenjem metoda dubokog učenja", 15. savjetovanje HRO CIGRE, Šibenik, Hrvatska, 2021. str. 1-13 (predavanje, domaća recenzija, cjeloviti rad (in extenso), znanstveni)
- [C₇] M. Kostelac, I. Pavić, T. Capuder, "Integracija vodikovih tehnologija u višeenergijska industrijska postrojenja", 15. savjetovanje HRO CIGRE, Šibenik, Hrvatska, 2023. str. 1-10 (predavanje, domaća recenzija, cjeloviti rad (in extenso), znanstveni)

Životopis

Matija Kostelac rođen je 1996. u Zagrebu. Upisao je Fakultet elektrotehnike i računarstva na Sveučilištu u Zagrebu u 2014. koji je diplomirao 2019. godine na Zavodu za visoki napon i energetiku. Iste godine se zapošljava kao asistent na Zavodu za visoki napon i energetiku na Fakultet elektrotehnike i računarstva Sveučilištu u Zagrebu.

Tijekom rada kao asistent sudjelovao je na raznim domaćim i međunarodnim projektima povezanim sa područjem elektroenergetike financiranim od strane Hrvatske zaklade za znanost i Europske unije. Također je sudjelovao u izradi stručnih studija financiranih od strane privrede. Sudjelovao je u provođenju nastave na predmetu upravljanje rizikom.

Tijekom rada na sveučilištu objavio je 4 rada u A kategoriji časopisa, 5 radova na međunarodnim konferencijama i 2 rada na domaćim konferencijama. Područje istraživanja radova obuhvaćaju integriranje industrijskih postrojenja na tržišta električne energije. Također se analizira mogućnost smanjivanja njihovih emisija stakleničkih plinova integracijom obnovljivih izvora energije i vodikovih tehnologija.

Član je znanstvenih i stručnih udruga IEEE, IEEE PES i HO CIGRE.

Detaljnem popisu radova moguće je pristupiti:

- <https://scholar.google.com/citations?user=-D4FEUAAAAJ&hl=en>
- <https://www.scopus.com/authid/detail.uri?authorId=57219535854>
- <https://www.webofscience.com/wos/author/record/24221112>