

Quality of experience driven video encoding adaptation strategies for cloud gaming under network constraints

Slivar, Ivan

Doctoral thesis / Disertacija

2021

Degree Grantor / Ustanova koja je dodijelila akademski / stručni stupanj: **University of Zagreb, Faculty of Electrical Engineering and Computing / Sveučilište u Zagrebu, Fakultet elektrotehnike i računarstva**

Permanent link / Trajna poveznica: <https://urn.nsk.hr/urn:nbn:hr:168:823938>

Rights / Prava: [In copyright](#) / [Zaštićeno autorskim pravom.](#)

Download date / Datum preuzimanja: **2024-07-10**



Repository / Repozitorij:

[FER Repository - University of Zagreb Faculty of Electrical Engineering and Computing repository](#)





University of Zagreb

FACULTY OF ELECTRICAL ENGINEERING AND COMPUTING

Ivan Slivar

**QUALITY OF EXPERIENCE DRIVEN
VIDEO ENCODING ADAPTATION
STRATEGIES FOR CLOUD GAMING
UNDER NETWORK CONSTRAINTS**

DOCTORAL THESIS

Zagreb, 2021



University of Zagreb

FACULTY OF ELECTRICAL ENGINEERING AND COMPUTING

Ivan Slivar

**QUALITY OF EXPERIENCE DRIVEN
VIDEO ENCODING ADAPTATION
STRATEGIES FOR CLOUD GAMING
UNDER NETWORK CONSTRAINTS**

DOCTORAL THESIS

Supervisor: Full Professor Lea Skorin-Kapov, PhD

Zagreb, 2021



Sveučilište u Zagrebu
FAKULTET ELEKTROTEHNIKE I RAČUNARSTVA

Ivan Slivar

**STRATEGIJE PRILAGODBE
VIDEOKODIRANJA USMJERENE
POBOLJŠAVANJU ISKUSTVENE
KVALITETE ZA IGRE ZASNOVANE NA
RAČUNALNOM OBLAKU USLIJED
OGRANIČENJA MREŽE**

DOKTORSKI RAD

Mentorica: prof. dr. sc. Lea Skorin-Kapov

Zagreb, 2021.

The doctoral thesis was completed at the University of Zagreb Faculty of Electrical Engineering and Computing, Department of Telecommunications.

Supervisor: Full Professor Lea Skorin-Kapov, PhD

This thesis has: 185 pages

Thesis number: _____

About the Supervisor

Lea Skorin-Kapov is Full Professor and head of the Multimedia Quality of Experience Research Lab (MUEXLab) at the University of Zagreb Faculty of Electrical Engineering and Computing. Her research interests include Quality of Experience assessment and modeling of advanced multimedia applications, QoE monitoring of encrypted video traffic, and cross-layer negotiation and management of QoS/QoE in networks. She teaches courses at bachelor, masters, and doctoral levels dealing with multimedia services, heuristic optimization methods, and communication networks.

She attended elementary school and high school in Canada and the USA, after which she received her Dipl.-Ing., M.S., and Ph.D. degrees in Telecommunications from the Faculty of Electrical Engineering and Computing (FER) at the University of Zagreb, Croatia, in 2001, 2004, and 2007, respectively. From 2001–2009 she was employed in the Research and Development Center of Ericsson Nikola Tesla d.d. (ETK), Zagreb, Croatia, doing research on QoS signaling, negotiation, and adaptation for multimedia services. From 2002-2009 she was also an adjunct teaching and research assistant at the Department of Telecommunications, FER, University of Zagreb.

Since 2010 she has been employed at the Department of Telecommunications, FER, University of Zagreb (as Assistant professor from 2010 until 2016, as Associate professor from 2016 until 2020, and Full professor from 2020 until the present). She is currently involved in a number of research and industry funded projects, and is principal investigator for the project “Modeling and Monitoring QoE for Immersive 5G-Enabled Multimedia Services” funded by the Croatian Science Foundation. She is a member of the Croatian Centre of Research Excellence for Data Science and Advanced Cooperative Systems, and a member of the Management Board of the Center for Artificial Intelligence at FER. She previously participated in EU COST Action IC1304 ACROSS (Autonomous Control for a Reliable Internet of Services), COST Action IC1003 (European Network on Quality of Experience in Multimedia Systems and Services, QUALINET), Celtic-Plus project “Quality of Experience Estimators in Networks” (QuEEN), FP7 OpenIoT, and EU SIIF project “ICT-based Competence Network for Innovative Services for Persons with Complex Communication Needs”.

She has published over 100 scientific papers, has served on numerous conference and workshop TPCs including ACM Multimedia, ACM Multimedia Systems, QoMEX, IEEE ICC, IEEE Infocom, ITC, and others, and has served as Program co-chair of the IEEE flagship Region 8 conference EUROCON, and the International Conference on Quality of Multimedia Experience (QoMEX 2017). She is on the editorial board of IEEE Transactions on Network and Service Management and Springer’s Multimedia Systems journal, and has served as Guest Editor for the IEEE Journal of Selected Topics in Signal Processing, and ACM Transactions on

Multimedia Computing, Communications, and Applications. She acts as reviewer for top rated journals including IEEE/ACM Transactions on Networking, IEEE Communications Magazine, IEEE Computer, Springer Multimedia Tools and Applications, IEEE Surveys and Tutorials. She was a contributing author to ETSI TS 103 294 “Speech and multimedia Transmission Quality (STQ); Quality of Experience: A Monitoring Architecture”.

She is currently serving as Chapter chair of the IEEE Communications Society—Croatia Chapter.

O mentoru

Lea Skorin-Kapov je redovita profesorica na Zavodu za telekomunikacije Fakulteta elektrotehnike i računarstva (FER) Sveučilišta u Zagrebu, gdje radi od 2010. godine. Voditeljica je istraživačkog laboratorija Multimedia Quality of Experience Research Lab (MUEXLab). Njezino glavno područje istraživačkog interesa jest modeliranje iskustvene kvalitete višemedijskih usluga, praćenje iskustvene kvalitete te mehanizmi upravljanja i optimizacije kvalitete usluge/iskustvene kvalitete u mrežama. Podučava na FER-ovom preddiplomskom, diplomskom i doktorskom studiju o višemedijskim uslugama i komunikacijama, heurističkim metodama optimizacije i komunikacijskim mrežama.

Pohađala je osnovnu i srednju školu u Kanadi i SAD-u, nakon čega je diplomirala 2001. godine, magistrirala 2004. godine, te doktorirala 2007. godine na Sveučilištu u Zagrebu FER, smjer telekomunikacije i informatika. Od 2001.-2009. godine radila je u Istraživačkom odjelu tvrtke Ericsson Nikole Tesle d.d. (ETK), Zagreb u jedinici za Istraživanje i razvoj, gdje se bavila istraživanjem područja signalizacije, pregovaranja i prilagodbe kvalitete usluge za napredne višemedijske usluge u telekomunikacijskim mrežama nove generacije. Godine 2002. izabrana je u naslovno suradničko zvanje mlađeg asistenta na FER-u.

2010. g. izabrana je u znanstveno-nastavno zvanje docent na FER-u, 2016. g. u znanstveno-nastavno zvanje izvanrednog profesora, a 2020. g. u znanstveno-nastavno zvanje redovitog profesora. Zaposlena je na Zavodu za telekomunikacije. Uključena je u razne istraživačke i industrijske projekte. Trenutno vodi istraživački projekt “Modeliranje i praćenje iskustvene kvalitete imerzivnih višemedijskih usluga u 5G mrežama” kojeg financira Hrvatska zaklada za znanost. Članica je Znanstvenog centra izvrsnosti za znanost o podacima i kooperativne sustave, te Upravnog odbora Centra za umjetnu inteligenciju na FER-u. Sudjelovala je kao članica Upravnog odbora COST IC1304 ACROSS (Autonomous Control for a Reliable Internet of Services), te kao članica Upravnog odbora COST IC1003 QUALINET (European Network on Quality of Experience in Multimedia Systems and Services), na Celtic-Plus projektu “Quality of Experience Estimators in Networks” (QuEEN), FP7 projektu OpenIoT i EU SIIF projektu “Kompetencijska mreža zasnovana na ICT-u za inovativne usluge namijenjene osobama sa složenim komunikaci-

jskim potrebama”.

Autorica je i koautorica više od 100 znanstvenih radova u časopisima, zbornicima radova s međunarodnih konferencija i knjigama. Djelovala je i djeluje kao članica tehničkog odbora za brojne međunarodne konferencije i radionice, uključujući: ACM Multimedia, ACM Multimedia Systems, QoMEX, IEEE ICC, IEEE Infocom, ITC, i ostale. Djelovala je kao supredsjedatelj programa za IEEE konferenciju EUROCON i konferenciju QoMEX 2017. Članica je uredničkog odbora časopisa IEEE Transactions on Network and Service Management i Springerovog časopisa Multimedia Systems, te je sudjelovala kao gostujući urednik za časopise IEEE Journal of Selected Topics in Signal Processing i ACM Transactions on Multimedia Computing, Communications, and Applications. Recenzira radove za brojne časopise, uključujući IEEE/ACM Transactions on Networking, IEEE Communications Magazine, IEEE Computer, Springer Multimedia Tools and Applications, IEEE Surveys and Tutorials. Sudjelovala je kao koautor u pisanju tehničke specifikacije ETSI TS 103 294 “Speech and multimedia Transmission Quality (STQ); Quality of Experience: A Monitoring Architecture”.

Trenutno obnaša funkciju predsjednice Odjela za komunikacije, hrvatske sekcije IEEE.

Acknowledgements

I would first like to thank my supervisor, Professor Lea Skorin-Kapov, for her patient support and assistance during the times I spent on my research and writing the thesis. I am extremely grateful for your patience to endure my occasional lack of motivation and inspiration.

I would also like to thank Professor Mirko Sužnjević for the inspiring thoughts and ideas given related to the research and other non-science areas.

I would like to thank my parents for their unconditional love and support during these turbulent times. If it were not for you, I highly doubt this thesis would be finished. Also, I would like to thank my brother Borna for all the time he was there for me when I needed to overcome negative thinking and transfer it to the virtual worlds.

I would also like to thank all my friends that I have neglected for years, who still had the patience for me. I apologize for that, and also apologize in advance, as this will probably happen again.

And finally, I would like to thank Ana for listening to Márquez's advice.

Abstract

Cloud gaming has been recognized as a promising shift in the online game industry, with the aim of implementing the “on demand“ service concept that has achieved market success in other areas of digital entertainment such as movies and TV shows. The concepts of cloud computing are leveraged to render the game scene as a video stream which is then delivered to players in real-time. The main advantage of this approach is the capability of delivering high-quality graphics games to any type of end user device, however at the cost of high bandwidth consumption and strict latency requirements. A key challenge faced by cloud game providers lies in configuring the video encoding parameters so as to maximize player Quality of Experience (QoE) while meeting bandwidth availability constraints. The main research challenge addressed in the scope of this thesis is how to configure these parameters to meet network resource constraints while maximizing QoE, and how to categorize games for the purpose of assigning appropriate video encoding adaptation strategies.

In this thesis, we present the results of six conducted empirical user studies that investigated the impact of network and video encoding parameters on user’s QoE for cloud gaming. Nine different games were tested during experiments, and the collected data about overall QoE was then used as an input for QoE modeling for six of the tested games based on manipulated parameters. Furthermore, the result indicated that the same video codec configuration could be utilized for different games under low network bandwidth availability.

Besides subjective studies, we gathered a large number of video gameplay traces and collected player actions from 25 different games. Based on a cluster analysis of obtained data, we propose a novel game categorization based on objective video metrics and gameplay characteristics that groups games into three game categories. The proposed categorization is then utilized for assigning appropriate video encoding adaptation strategies, proposed based on collected empirical data during subjective studies, for derived game categories.

The proposed video encoding adaptation strategies are evaluated in a case study of QoE-aware resource allocation for multiple cloud gaming users sharing a bottleneck link. The results have shown that the algorithms utilizing proposed video encoding adaptation strategies achieve higher average MOS scores compared to a baseline algorithm that allocates the same amount of resources to all active players.

Keywords: cloud gaming, Quality of Experience, QoE estimation, clustering, video encoding adaptation strategies

Strategije prilagodbe videokodiranja usmjerene poboljšavanju iskustvene kvalitete za igre zasnovane na računalnom oblaku uslijed ograničenja mreže

Pružanje različitih vrsta sadržaja “na zahtjev” (engl. *on demand*) bilo gdje i na bilo kojem uređaju je dominantan trend koji je posljednjih godina prisutan kod umreženih usluga. Zabilježen je velik porast popularnosti usluga zasnovanih na računalnom oblaku (engl. *cloud-based services*), koje iskorištavaju “neograničene” računalne resurse u oblaku za izračun i pohranu podataka. Rastuća potražnja i korištenje računalnih usluga zasnovanih na računalnom oblaku smatraju se glavnim pokretačima rasta i razvoja računarstva u oblaku, čija infrastruktura se vodi kao operativni trošak te omogućuje korisnicima minimiziranje inicijalnih ulaganja. Nadalje, implementacija 5G mreža dodatno će smanjiti kašnjenje i povećati mrežnu propusnost, čime će se poboljšati mrežne performanse mrežnih usluga, a to će također rezultirati porastom broja novih i daljnjim razvojem postojećih usluga zasnovanih na računalnom oblaku.

Igre zasnovane na računalnom oblaku (engl. *cloud gaming*) su prepoznate kao obećavajući novi trend u industriji mrežnih igara, implementirajući koncept usluge na zahtjev koji je postigao tržišni uspjeh u drugim područjima digitalne zabave, poput filmova i TV emisija. Tehnologija računarstva u oblaku je iskorištena kako bi se iscrtana scena igre u obliku video strujanja dostavila do krajnjeg korisnika u stvarnom vremenu. Izvođenje resursno zahtjevnih zadataka (logika igre, iscrtavanje virtualne 2D/3D scene, te videokodiranje) je premješteno na poslužitelje u računalnom oblaku, dok je tanki klijent (engl. *lightweight client*) odgovoran za dekodiranje i prikaz primljenog video sadržaja te praćenje korisničkih akcija. Glavna prednost ovog pristupa je mogućnost igranja grafički visokokvalitetnih igara na bilo kojoj vrsti uređaja (bez potrebe stalnog kupovanja nove skupe opreme te nadogradnje postojeće opreme koja je potrebna za igranje takvih naprednih igara). Također, umjesto kupovanja fizičkih ili digitalnih kopija novih igara, većina postojećih platformi igara zasnovanih na računalnom oblaku pruža neki oblik pretplate za igranje najnovijih igara, što dodatno povećava uštedu za krajnjeg korisnika.

Iako igre zasnovane na računalnom oblaku pružaju brojne pogodnosti krajnjim korisnicima, napredne mogućnosti takve usluge rezultiraju visokim zauzećem širine propusnog pojasa mreže i strogim zahtjevima za niskim mrežnim kašnjenjem. Strujanje sadržaja igre u obliku video zapisa prema klijentskim uređajima rezultira značajnim povećanjem u zahtjevima na širinu propusnog pojasa mreže u usporedbi s “tradicionalnim” mrežnim igrima. Dostupni mrežni resursi variraju kroz vrijeme, kao rezultat promjenljivog stanja pristupne mreže ili promjenljivog broja igrača koji pristupaju usluzi preko zajedničke veze, te stoga je potrebna učinkovita i dinamička prilagodba usluge na poslužitelju (npr. prilagodba broja okvira u sekundi (engl. *frames per*

second, FPS), brzine videokodiranja, rezolucije). Ključni izazov s kojim su suočeni davatelji usluga igara zasnovanih na računalnom oblaku je prilagodba parametara videokodiranja kako bi se maksimizirala korisnikova iskustvena kvaliteta (engl. *Quality of Experience*, QoE), poštujući ograničenja širine propusnog pojasa mreže.

Glavni istraživački izazov koji je istražen u okviru ovog doktorskog rada jest upravo kako prilagoditi ove parametre, a da se pritom maksimizira iskustvena kvaliteta i zadovolje ograničenja mrežnih resursa, te kako kategorizirati igre u svrhu dodjeljivanja odgovarajuće strategije prilagodbe videokodiranja. Postojeći žanrovi igara uglavnom nisu formalno definirani temeljeno na skupu objektivnih metrika, nego neformalno na temelju različitih tipova mehanika igre (engl. *game mechanics*). Dodatno, moguće je da prema tim postojećim žanrovima igara više igara pripada različitim žanrovima, što dodatno otežava upotrebu postojećih žanrova igara u svrhu odabira odgovarajućih strategija prilagodbi videokodiranja (npr. elementi igara uloga (engl. *role playing game*, RPG), kao što su iskustveni bodovi i klase likova, mogu se pronaći u brojnim drugim žanrovima od strategija u stvarnom vremenu (engl. *real time strategy*, RTS) do pucačina u prvom licu (engl. *first person shooter*, FPS)). Većina izvedenih QoE-modela može se primijeniti na samo jednu specifičnu igru (za koju je taj QoE-model bio primarno izveden) zbog značajnih razlika između igara koje pripadaju istoj kategoriji na temelju postojećih klasifikacija žanrova igara. Zbog toga je potrebno oblikovati odgovarajuću kategorizaciju igara za igre zasnovane na računalnom oblaku temeljenu na objektivnim karakteristikama igara (video metrikama, intenzitetu korisničkih akcija) koja se kasnije može iskoristiti kao pomoćni alat pri izvođenju preciznih QoE-modela za predložene kategorije igara. Samim time bi se takva kategorizacija igara mogla koristiti za određivanje odgovarajuće strategije prilagodbe videokodiranja za kategorije igara, što bi moglo u budućnosti automatizirati proces odluke odabira najprikladnije strategije prilagodbe videokodiranja za pojedinu igru, pri čemu bi se također mogla izbjeći potreba za provođenjem dodatnih korisničkih studija za nove igre.

U prvom poglavlju rada obrazložen je istraživački problem te je dana motivacija za njegovo istraživanje. Definirana su ključna istraživačka pitanja koja su obrađena u okviru doktorskog rada, te su predstavljeni sažeti glavni doprinosi rada.

Paradigma igara zasnovanih na računalnom oblaku je opisana u drugom poglavlju, te su predstavljene ključne komponente arhitekture usluge. Opisane su specifičnosti videokodiranja i strujanja za igre zasnovane na računalnom oblaku, te su navedene glavne prednosti i nedostaci same usluge. Na kraju poglavlja je dan pregled postojećih platformi igara zasnovanih na računalnom oblaku u vrijeme pisanja rada (kraj 2020. godine). Vidljivo je da je s porastom igranja u pokretu (engl. *mobile gaming*) te planiranim postavljanjem 5G mreža koje pružaju niski odziv i visoku propusnost, paradigma igara zasnovanih na računalnom oblaku postala popularni trend kod igara. Većina najvećih igračih i tehnoloških tvrtki je prepoznala igre zasnovane na računalnom oblaku kao obećavajuće sredstvo za tržišnu ekspanziju njihovih postojećih servisa igara, te

su počele javno testirati vlastita rješenja igara zasnovanih na računalnom oblaku.

Nakon danog pregleda platformi igara zasnovanih na računalnom oblaku u prethodnom poglavlju, treće poglavlje opisuje stanje razvoja (engl. *state-of-the-art*) metoda procjena i modeliranja iskustvene kvalitete za igre zasnovane na računalnom oblaku. Prvo je opisan generalni koncept iskustvene kvalitete, te su prezentirane metode procjene iskustvene kvalitete. Zatim je dan pregled značajki i metoda procjene iskustvene kvalitete mrežnih igara. Na kraju je dan pregled studija koje su istraživale procjenu i modeliranje iskustvene kvalitete za igra zasnovane na računalnom oblaku. Na temelju opsežne analize stanja razvoja provedenih istraživanja o iskustvenoj kvaliteti igara zasnovanih na računalnom oblaku, identificirana su ključna istraživačka pitanja koja su zatim obrađena u sklopu doktorskog rada.

U ovom radu predstavljani su rezultati šest empirijskih korisničkih studija koje su istraživale utjecaj parametara mreže i videokodiranja na korisničku iskustvenu kvalitetu za igre zasnovane na računalnom oblaku. Glavni cilj provedenih korisničkih studija bio je istražiti kako i u kojem obimu parametri videokodiranja utječu na doživljenu iskustvenu kvalitetu za svaku testiranu igru prilikom igranja na mreži promjenljive širine propusnog pojasa mreže. Testirale su se igre koje su pripadale različitim žanrovima igara kako bi se odredilo mogu li se iste konfiguracije video kodeka (u pogledu brzine videokodiranja i broja okvira u sekundi) dodijeliti igrama iz različitih žanrova igara. U četvrtom poglavlju su tako predstavljene dvije korisničke studije (Studije S1 i S2) koje su istraživale utjecaj mrežnih parametara na QoE za igre zasnovane na računalnom oblaku. Studija S1 je istraživala uvodi li iscrtavanje i strujanje sadržaja igre do klijentskih uređaja degradacije iskustvene kvalitete u odnosu na “tradicionalno” mrežno igranje, dok je Studija S2 analizirala komercijalnu platformu NVIDIA GeForce NOW i njene mogućnosti prilagodbe usluge tijekom promjenljivih ograničenja mrežnih resursa. Rezultati studija su pružili uvid u ograničenja trenutno dostupnih mehanizama prilagodbe za platforme igara zasnovane na računalnom oblaku u vrijeme izvođenja studija, te su pružile korisne informacije za oblikovanje metodologije sljedećih korisničkih studija (Studije S3-S6).

U sljedećem, petom, poglavlju predstavljani su rezultati Studija S3-S6 koje su istraživale odnos između QoE-a i parametara videokodiranja (brzine videokodiranja, broja okvira u sekundi). Kako prilagoditi parametre videokodiranja uslijed ograničenja širine propusnog pojasa mreže bio je istraživački problem koji je bio obrađen u navedenim studijama. Četiri kontrolirane korisničke studije su provedene, te su dobiveni empirijski podaci prikupljeni putem upitnika analizirani odgovarajućim statističkim metodama, te su se zatim iskoristili za dobivanje modela za procjenu QoE-a za testne igre. Osim toga, dobiveni rezultati iz Studija S3 i S4 su pokazali da različite konfiguracije video kodeka mogu biti primijenjene za različite igre kako bi se poboljšala igračeva iskustvena kvaliteta uslijed ograničenja širine propusnog pojasa mreže. No, također rezultati iz Studija S5 i S6 su pokazali da se ista konfiguracija video kodeka može koristiti za igre iz različitih žanrova igara. Tako su rezultati korisničkih studija pokazali da trenutno pos-

tojeće klasifikacije igara nisu odgovarajuće za određivanje odgovarajuće konfiguracije video kodeka za testirane igre, te je time pokazana potreba za novom, prikladnijom kategorizacijom igara za igre zasnovane na računalnom oblaku.

Šesto poglavlje rada sažima prijedloge nove kategorizacije igara za igre zasnovane na računalnom oblaku temeljene na objektivnim video metrikama i karakteristikama igara. Prvo je provedena analiza objektivnih karakteristika igara (intenzitet korisničkih akcija, video metrike) kako bi se identificirale razlike između video strujanja različitih igara kod igara zasnovanih na računalnom oblaku. Zatim je opisana metodologija za prikupljanje velikog broja video zapisa igranja te pripadajućih igračevih akcija kojom je prikupljen velik i javno dostupan skup podataka koji se sastoji od 225 različitih video zapisa igranja 25 različitih igara, pri čemu su video zapisi obilježeni s pripadajućim objektivnim video metrikama. Kako bi se identificirale kategorije igara, provedena je klaster analiza *k*-srednjih vrijednosti (engl. *k-means cluster analysis*) dobivenih podataka, a rezultat te analize jest nova kategorizacija igara zasnovana na objektivnim video metrikama i karakteristikama igranja koja grupira igre u tri kategorije.

Predložena kategorizacija igara je s prethodno dobivenim QoE-modelima korištena pri definiranju triju novih strategija pristupa prilagodbi videokodiranja, što je opisano u sedmom poglavlju. Predložene strategije pristupa prilagodbi videokodiranja sadrže različite strategije prilagodbe videokodiranja usmjerene poboljšavanju iskustvene kvalitete koje pružatelj usluge igara zasnovanih na računalnom oblaku može primijeniti kako bi izvršio odgovarajuću prilagodbu usluge za različite igre. Te strategije pristupa prilagodbi videokodiranja se razlikuju po tome kako prilagođavaju parametre video kodeka (brzinu videokodiranja, broja okvira u sekundi) za različite vrste igara prilikom ograničenja dostupnosti resursa.

U osmom poglavlju su predložene strategije prilagodbe videokodiranja evaluirane u studijskom slučaju dodjeljivanja resursa, koje je vođeno iskustvenom kvalitetom, korisnicima usluge igara zasnovanih na računalnom oblaku koji dijele mrežnu vezu. Opisan je optimizacijski problem dodjele resursa zasnovane na iskustvenoj kvaliteti koji je zatim korišten u studijskom slučaju dodjeljivanja resursa. Također su opisani algoritmi za dodjeljivanje resursa koji su se koristili za rješavanje formuliranog optimizacijskog problema. Numerički rezultati su pokazali da algoritmi koji koriste predložene strategije prilagodbe videokodiranja ostvaruju veće prosječne MOS rezultate u usporedbi s osnovnim algoritmom (engl. *base algorithm*) koji dodjeljuje istu količinu resursa svim aktivnim igračima.

U posljednjem poglavlju sumirani su glavni zaključci doktorskog rada, te su opisani pojedini rezultati povezani s ključnim istraživačkim pitanjima. Također, ograničenja rada i mogući budući rad u ovom istraživačkom području su navedeni na kraju devetog poglavlja.

Istraživanjem opisanim u ovom radu ostvaren je znanstveni doprinos koji se sastoji od sljedećih elemenata:

- Kategorizacija igara zasnovanih na računalnom oblaku utemeljena na podskupu objek-

tivnih karakteristika igre, s ciljem oblikovanja različitih strategija prilagodbe videokodiranja za različite kategorije igara.

- Empirijski izvedeni modeli iskustvene kvalitete za predložene kategorije igara koji kvantificiraju odnos između iskustvene kvalitete i parametara videokodiranja.
- Predložene strategije prilagodbe videokodiranja usmjerene poboljšavanju iskustvene kvalitete za igre zasnovane na računalnom oblaku i evaluirane na studijskom slučaju optimizacije iskustvene kvalitete tijekom promjenljivih ograničenja mrežnih resursa.

Ključne riječi: igre zasnovane na računalnom oblaku, iskustvena kvaliteta, predviđanje iskustvene kvalitete, grupiranje, strategije prilagodbe videokodiranja

Contents

1. Introduction	1
1.1. Background and motivation	1
1.2. Problem statement	3
1.3. Method of solution and scope	7
1.4. Summary of contributions	10
1.5. Thesis structure	10
2. Cloud gaming: architecture & platforms	11
2.1. Cloud gaming architecture	11
2.2. Video encoding and streaming	12
2.3. Cloud gaming benefits and drawbacks	14
2.4. Cloud gaming platforms	14
2.5. Chapter summary	21
3. State of the art review: Quality of Experience assessment and modeling for cloud gaming	22
3.1. Quality of Experience	22
3.1.1. Definitions	23
3.1.2. QoE assessment methods	23
3.2. Assessing QoE for online gaming	25
3.2.1. Online gaming QoE aspects	25
3.2.2. QoE assessment methods for online gaming	27
3.2.3. Standardization	27
3.3. Overview of studies addressing cloud gaming QoE	31
3.3.1. Game categorization for cloud gaming	35
3.3.2. QoE-aware resource allocation for cloud gaming	36
3.4. Chapter summary	37
4. Impact of network factors and game type on QoE	38
4.1. Study S1 - Degradation in gaming QoE imposed by switching to cloud gaming	38

4.1.1.	Methodology	39
4.1.2.	Results	42
4.2.	Study S2 - Service adaptation mechanisms in light of variable network conditions	48
4.2.1.	Analysis of GeForce NOW service adaptation behavior	48
4.2.2.	QoE evaluation of the GeForce NOW adaptation strategy	54
4.3.	Chapter summary	59
5.	Impact of system factors and game type on QoE	60
5.1.	Study S3 - Impact of video encoding parameters on QoE	61
5.1.1.	Methodology	62
5.1.2.	Results	64
5.1.3.	QoE model for a fast-paced game	67
5.1.4.	QoE model for a slow-paced game	68
5.2.	Study S4 - Should different adaptation strategies be applied for different types of games?	70
5.2.1.	Methodology	70
5.2.2.	Results	74
5.2.3.	QoE models derived from the data collected in Study S4	84
5.3.	Studies S5 and S6 - Are there cases when the same video encoding adaptation strategy should be employed for games belonging to different genres?	88
5.3.1.	Methodology in Study S5	89
5.3.2.	Results from Study S5	91
5.3.3.	QoE models derived from the data collected in Study S5	97
5.3.4.	Methodology in Study S6	99
5.3.5.	Results from Study S6	101
5.3.6.	QoE models derived from the data collected in Study S6	107
5.4.	Chapter summary	110
6.	Game categorization for cloud gaming	111
6.1.	Video characterization	112
6.2.	Acquiring a dataset of gameplay video traces	113
6.2.1.	Preliminary analysis of video game traces	113
6.2.2.	Methodology for data collection	114
6.3.	Analysis of acquired video traces	115
6.4.	Clustering results for two clusters	117
6.5.	Clustering results for three clusters	120
6.6.	Chapter summary	123

7. Video encoding adaptation strategies for cloud gaming	124
7.1. QoE models and adaptation strategies for three game categories	124
7.2. Adaptation approach A: optimization of QoE based on derived per-category QoE models	128
7.3. Adaptation approach B: frame rate adaptation based on achievable bitrate ranges	129
7.4. Adaptation approach C: bitrate and frame rate adaptation based on achievable bitrate ranges	131
7.5. Chapter summary	132
8. QoE-aware resource allocation for cloud gaming under variable network resource availability constraints	133
8.1. QoE-driven service adaptation for cloud gaming	133
8.2. Problem formulation for QoE-aware resource allocation	135
8.3. Algorithm description for solving the formulated problem	137
8.4. Description of the case study	139
8.5. Performance evaluation of resource allocation algorithms compared to the base- line algorithm	139
8.6. Performance evaluation and comparison of Adaptation approaches A, B, and C	147
8.6.1. Max-avg quality algorithm	147
8.6.2. Max-min quality algorithm	149
8.6.3. Performance comparison of derived game category QoE models with QoE models for individual games	150
8.7. Performance evaluation of the impact of parameter θ on video bitrate and MOS distribution	151
8.8. Chapter summary	152
9. Conclusions & future work	154
9.1. Conclusions	154
9.2. Limitations and future work	157
9.2.1. Implications of different resolutions on the results	157
9.2.2. Implications of different codecs on the results	157
9.2.3. Improvement of derived QoE models	157
9.2.4. Limitations of the game categorization	158
9.2.5. Limitations of the service adaptation problem	158
9.2.6. The future of cloud gaming	159
Bibliography	160
List of Figures	173

List of Tables	179
List of Abbreviations	180
Biography	182
Životopis	185

Chapter 1

Introduction

This chapter presents the background and motivation for the thesis (Section 1.1), discusses the problem statement (Section 1.2) and method of solution (Section 1.3), and summarizes the main thesis contributions (Section 1.4).

1.1 Background and motivation

Providing different types of content “on demand” anywhere and on any device has been a dominant market trend for networked services in recent years. Cloud-based services have been rapidly emerging, utilizing cloud-based computing and storage resources. According to the survey conducted by Flexera in 2019 [1], 94% of the surveyed enterprises used cloud-based services, while 69% of them used at least one private and one public cloud service. By the end of 2025 the cloud computing market is anticipated to reach around USD 623.3 billion, more than doubling the market value from 2019 (USD 272 billion) [2]. High adoption and the rising demand for cloud-based computing services are considered to be the main drivers behind cloud computing growth, enabling enterprises to minimize expenses on assets, and treat the cloud infrastructure as an operational expense. Furthermore, the deployment of 5G networks is expected to facilitate the growth of cloud-based services, as providing support for reduced latency and increased throughput will improve the network performance of emerging cloud-based services.

When it comes to games, the cloud-based paradigm is implemented through “cloud gaming” (also referred to as game streaming or gaming on demand), whereby game content is delivered from a server to a client in the form of a video stream [3]. The execution of resource-heavy tasks (the game logic, rendering of the 3D virtual scene, and video encoding) are performed at the server, while the lightweight client is responsible for video decoding and capturing of client input. Avoiding the high costs of having to purchase new hardware and gaming consoles required to play the latest games in the highest graphics are the main drivers behind the market adoption of cloud gaming, as these costs are avoided by transitioning to cloud gaming. Moreover,

instead of buying physical or digital copies of new games, most cloud gaming platforms offer some kind of subscription plan to play the latest games, further increasing savings for end users. These aspects, together with the possibility for new users to quickly and simply transition to using cloud gaming services, resulted in the growth of the cloud gaming market in recent years. According to a 2020 Technavio report [4], the global cloud gaming market size has the potential to grow by USD 2.7 billion during the period 2020-2024, with an annual growth rate of nearly 29 %. The online game industry has recognized the cloud gaming paradigm as a promising shift towards enabling the delivery of high-quality graphics intensive games to nearly any end user device, thus alleviating the need for devices with high-end graphics and processor support. A number of industry leaders have been expanding their services by implementing their own game streaming solutions (e.g., Sony's Playstation Now service [5], NVIDIA's GeForce NOW (GFN) service [6] and Google's Stadia [7] as examples of cloud gaming services that allow users online access to a selection of games), with Sony operating the world's most widespread cloud gaming platform with more than 700,000 users [8]. Moreover, some game companies provide in-home game streaming that includes the streaming of video games from a local server to other devices in a local network. This approach is applied in Sony's Remote Play service [9] and Valve's Remote play service [10] for the PC gaming platform Steam.

While cloud gaming represents a promising paradigm shift in the domain of online gaming, challenges arise in meeting the strict bandwidth and delay requirements of game streaming. With powerful servers being responsible for executing the game logic, rendering of the 3D virtual scene, encoding, and streaming game scenes to client devices, the result is a significant increase in downlink bandwidth requirements as compared to "traditional" online games [11, 12]. Thus, a challenge faced by cloud game providers looking to stream their games over the Internet is meeting the Quality of Experience (QoE) requirements of players under various network conditions. With available network resources varying over time, subject to issues such as varying access network conditions or a varying number of players accessing a bottleneck link, there is a need for efficient and dynamic service adaptation strategies on the game server to meet different bandwidth availabilities (e.g., adaptation of video frame rate, bitrate, resolution). A challenge faced by cloud gaming providers is configuration and adaptation of the video encoding parameters used for game streaming with respect to different network bandwidth conditions. The cloud gaming server has very limited control over network latency, apart from reducing its own sending rates to avoid filling up router queues during congestion [13]. Hence, codec re-configuration decisions made by the cloud gaming server (in terms of chosen resolution, target bitrate, and frame rate values) are driven by measured available effective bandwidth (bandwidth that denotes the available resources for video bitrates, ignoring bandwidth usage of lower-layer protocols). Furthermore, some of the studies that have conducted subjective end user Quality of Experience tests have shown that different codec configuration strategies should be considered

for different game types [13, 14, 15]. In other words, selecting the appropriate video encoding parameters for different cloud games affects the efficiency of the service adaptation in terms of the impact on QoE. While there are traditional game genre-based classifications, and certain scientific approaches in classifying games (e.g., based on camera perspective [16] and game characteristics [17]), missing so far is a systematic approach in differentiating between game characteristics specifically for cloud gaming.

1.2 Problem statement

The impact of heterogeneous and variable network conditions on the end user QoE of cloud gaming has lately been addressed by various researchers [18, 19, 20, 21, 22, 23, 24, 25, 26, 27, 28, 29, 30, 31, 32]. Cloud-based games (regardless of the game genre) are as sensitive to latency as First Person Shooter (FPS) games are in “traditional” online gaming (the FPS genre is regarded as the most sensitive game genre in online gaming) [33]. Moreover, faster-paced games, such as First Person Shooters, require a lot of game screen changes and demand high user interaction, thus are challenging to support when played in a cloud environment, where additional cloud server delay arise from video encoding/decoding and user input processing. While high response times cause considerable QoE degradation and user dissatisfaction for faster-paced games, gaming QoE for the FPS genre is not significantly influenced by packet loss. That can be explained by the high frequency of the game screen changes that distract users from detecting compression artefacts incurred due to high packet loss [22].

Going beyond studying the impact of network factors on cloud gaming QoE, fewer studies have addressed the impact of different video encoding parameters on QoE [13, 14, 15, 18, 28, 34, 35]. Important findings from QoE studies have shown that for most of the tested games, high frame rate leads to better overall QoE scores when bitrate is high, while for lower bitrate, reduced frame rate can lead to improved QoE [13, 15]. However, for certain games, keeping frame rate high when bitrate is low resulted with higher user’s QoE [35], leading to contradictory results from different QoE studies. Given the wide diversity of games and their corresponding QoE requirements, it is clear that different codec configuration strategies may be applied to different categories of games.

While most findings concerning cloud gaming QoE have recognized game genre as a key factor impacting QoE, studies have reported that available state-of-the-art commercial cloud gaming solutions do not take into account game genre while performing adaptation of video parameters (e.g., bitrate, frame rate, resolution) to meet system or network resource constraints [29, 36]. Missing is a classification of digital games based on objective game characteristics that could be used to categorize games and enable developing QoE models applicable for different game categories (recent activities of Study Group 12 of ITU-T (International Telecommuni-

cation Union - Telecommunication Standardization Sector) have addressed this issue, and an example of the potential categorization is given in [17]). We note that by QoE models we are referring to models quantifying the relationship between QoE and application-level video metrics such as bitrate, frame rate, and resolution. Current game genres are typically not defined based on a set of metrics, but more informally based on different types of game mechanics. Additionally, there are many games belonging to multiple genres, which makes it hard to use existing genre classification in this approach (e.g., elements of role playing games (RPG), such as experience points, characters classes, and equipment-based progression, can be found in many other genres from real time strategies (RTS) to first person shooters(FPS)). As a result, most of the currently developed QoE models can be applied to only one specific game for which they were primarily derived for due to significant differences (in terms of graphics detail, game-play pace, input rate, etc.) between games grouped in the same category based on existing game genre classifications. Therefore, there is a need to design an appropriate game categorization for cloud gaming based on objective game characteristics (video metrics, the intensity of user interaction) that can be later used as a tool when aiming to develop accurate QoE models for derived game categories. Consequently, such a categorization could then be used for determining appropriate video adaptation strategies for categories of games, which could in the future automate the process of deciding on the most appropriate video encoding adaptation strategy for a particular game, alleviating the need to conduct subjective studies for additionally considered (or newly emerging) games.

Following a thorough analysis of state of the art work (provided in Chapter 3), the following research questions have been identified that will be addressed in the scope of the thesis:

- **RQ1:** How can the relationship between QoE and selected video encoding parameters (bitrate, frame rate) be quantified for cloud gaming?
- **RQ2:** How should video encoding parameters of the game video stream be adapted (or reconfigured) in light of decreased bandwidth availability, so as to maximize QoE?
- **RQ3:** Can the same video encoding parameters (in terms of bitrate and frame rate), derived so as to maximize QoE in light of bandwidth constraints, be assigned to games belonging to different genres (according to existing game categorizations)?
- **RQ4:** Is it possible to objectively categorize games based on application-level metrics such that the same video encoding adaptation strategy (in terms of configuring bitrate and frame rate so as to maximize QoE) can be assigned for all games in the same category in light of decreased bandwidth availability?
- **RQ5:** Can the assigned video encoding adaptation strategies for derived game categories be utilized for maximizing QoE and fairness among players sharing a common network bottleneck link?

These research questions are mapped to a set of activities comprising the overall research

methodology (Section 1.3), and further to novel scientific contributions provided as the output of this thesis (Section 1.4). This mapping is portrayed in Figure 1.1.

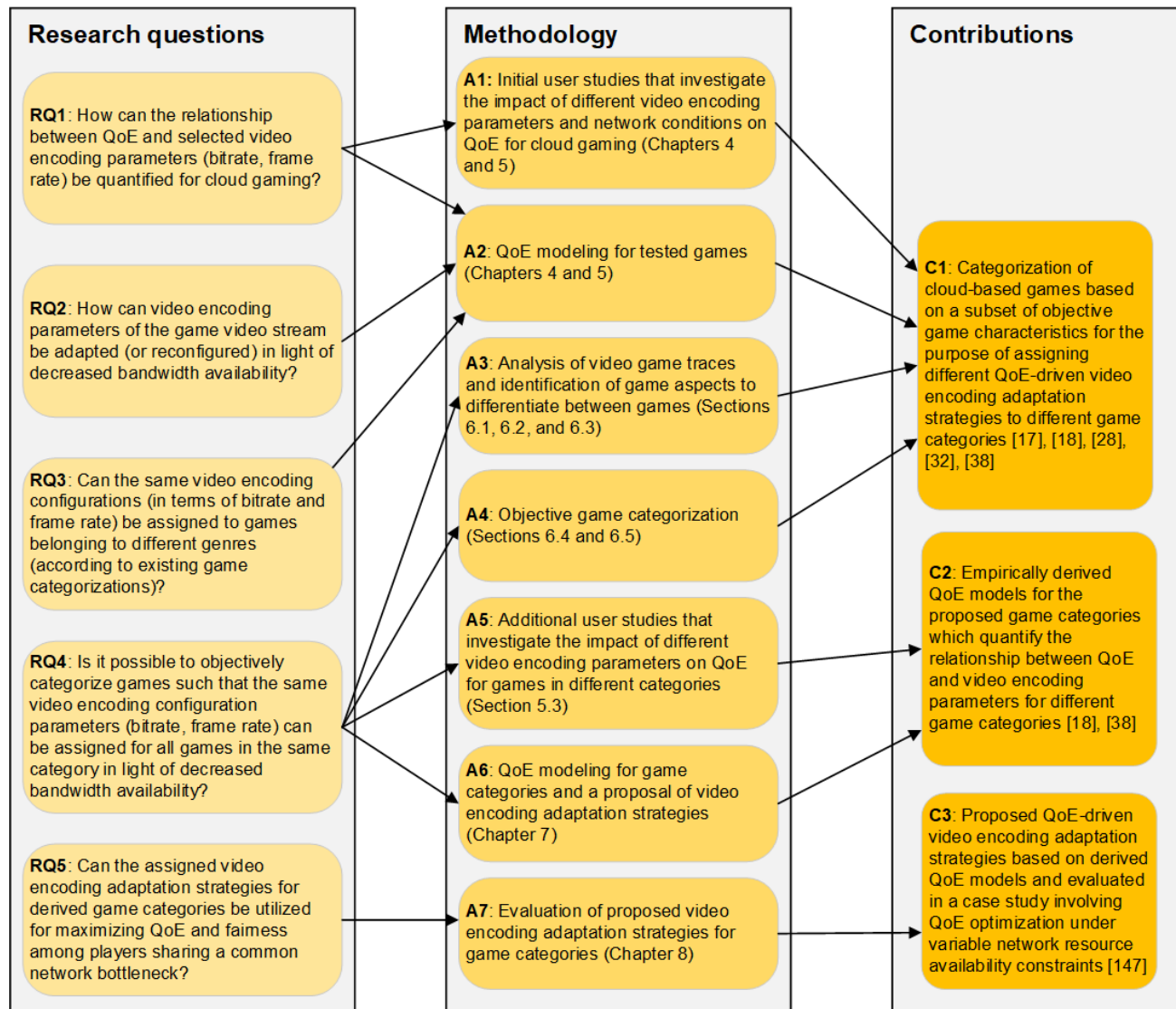

Figure 1.1: Mapping of addressed research questions, activities comprising the research methodology, and contributions of the thesis. Publications corresponding to each contribution are listed.

1.3 Method of solution and scope

The research was conducted in several phases. The overall research methodology is shown in Figure 1.2. A total of six user studies (labeled as S1-S6) were conducted over the course of four years, with details regarding the number of involved participants and tested QoE influence factors given in Table 1.1.

The first phase of the research methodology included conducting initial user studies in a laboratory environment to investigate the impact of different video encoding parameters and network conditions on QoE for cloud gaming (**Activity A1**). The main goal of the user studies was to investigate how and to what extent video encoding parameters affect perceived QoE for each of the tested games under variable bandwidth availability. The aim was to test games belonging to different genres so as to determine whether or not the same video encoding configurations (in terms of bitrate and frame rate) can be assigned to games belonging to different genres. The first two user studies (Studies S1 and S2) focused on the impact of network parameters on QoE for cloud gaming, while Studies S3-S6 investigated the relationship between QoE and video encoding parameters (bitrate, frame rate). All user studies consisted of gaming sessions that were conducted in a laboratory environment. Each of the gaming sessions contained multiple test scenarios that differ according to different video encoding parameters and network conditions. To investigate the impact of network parameters on users QoE, bandwidth, latency, and packet loss were manipulated in Studies S1 and S2. In Studies S3-S6, video frame rate and bitrate were manipulated to control/influence image quality and smoothness of gameplay. Even though the adaptation of video resolution is commonly utilized to improve user's QoE for video streaming [37], the manipulation of video resolution was omitted from our experiments. PC hardware that we used as cloud gaming servers was not powerful enough to render tested games at higher resolutions at constant 60 fps. Furthermore, to play tested games at higher resolution (1080p) would result with an increase of bandwidth requirements, leading to an increase of tested conditions. This would this would prolong already long studies, or constrain us to investigate a smaller number of test conditions. Additionally, at the time we conducted subjective studies, existing cloud gaming platforms streamed video content at 720p [38], and other researchers were also using the same resolution in their studies [13, 39]. Consequently, all tested games were played at a fixed 720p resolution. Following the conducted user studies given in Table 1.1, empirical data was analyzed using appropriate statistical methods (**Activity A2**), and QoE models for tested games were proposed.

Given that the first phase identified the need for different video encoding adaptation strategies for different games, Phase 2 included an analysis of objective game characteristics (intensity of user actions, video metrics) (**Activity A3**) to identify game aspects which can be used to quantitatively or qualitatively identify the differences between video streams of different games

Table 1.1: Summary of conducted user studies

Study	Year	Publication	Number of participants	Tested QoE influence factors	Section
Study 1 (S1)	2014	[25]	35	latency, packet loss	Section 4.1
Study 2 (S2)	2016	[29]	15	bandwidth, latency, packet loss	Section 4.2
Study 3 (S3)	2014	[14]	15	bitrate, frame rate	Section 5.1
Study 4 (S4)	2015	[15]	52	bitrate, frame rate	Section 5.2
Study 5 (S5)	2016	[35]	28	bitrate, frame rate	Section 5.3.1
Study 6 (S6)	2018	Unpublished	39	bitrate, frame rate	Section 5.3.4

in cloud gaming. Therefore, a sufficient number of representative games from traditional game genre categorization groups were investigated. For each of the selected games, experiments were performed in an attempt to find a subset of game characteristics that have a significant impact on the characteristics of the video stream, thus in some way affecting the performance of the cloud gaming service. As a result, a large and openly available dataset of 225 different gameplay videos was recorded across 25 different games and annotated with objective video metrics.

The analysis performed in Phase 2 provided input for the game categorization which was subsequently utilized for selecting appropriate video encoding adaptation strategies for cloud gaming. Based on the analyzed objective video and gameplay characteristics, a cluster analysis was performed in Phase 3 (**Activity A4**). An initial cluster analysis grouped games into 2 clusters characterized by objective video metrics PFIM (Percentage of Forward/backward or Intra-coded Macroblocks) and IBS (Intra-coded Block Size), described in Section 6.1. However, an additional QoE study conducted in the next phase (**Activity A5**) showed the need to extend the proposed categorization, as tested games that were grouped in the same category were empirically found to have different QoE requirements. As a result, the objective game categorization was redefined, and the intensity of user actions (referred to actions per minute, APM) was considered as an additional metric in the clustering process, finally resulting in three clusters (corresponding to game categories). QoE models for game categories were obtained based on the previously collected data during QoE studies. Newly derived QoE models were utilized for proposing novel video encoding adaptation strategies that could be exploited by a service provider to perform appropriate service adaptation for different games (**Activity A6**).

Finally, the last research phase included a case study involving performance evaluation of proposed video encoding adaptation strategies (**Activity A7**). An optimization problem for QoE-aware resource allocation for multiple cloud gaming users sharing a bottleneck link was formulated. The optimization problem was solved by utilizing algorithms that employ proposed video encoding adaptation strategies. The impact on the resource allocation outcome was investigated while jointly considering both quality and QoE fairness as optimization objectives.

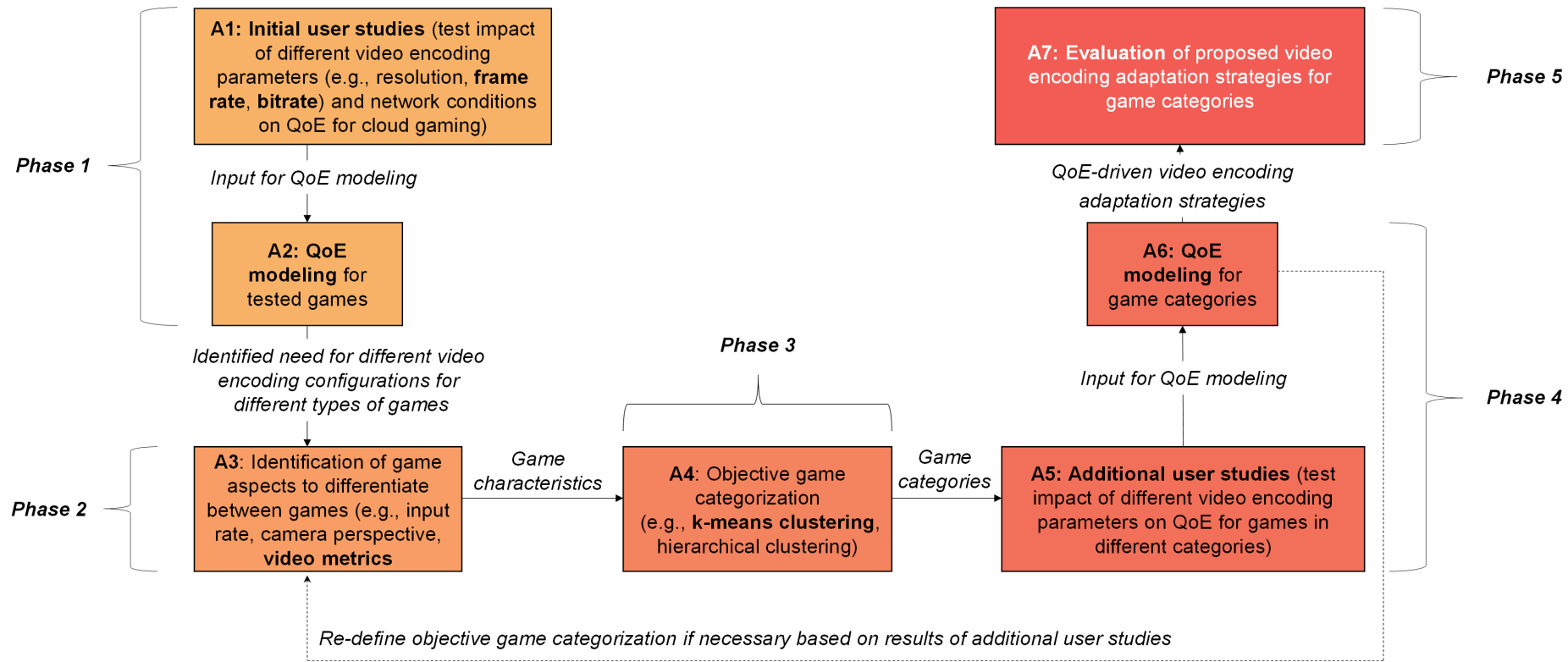

Figure 1.2: Overall methodology used in this doctoral thesis

1.4 Summary of contributions

The contributions of this thesis may be summarized as follows:

- **C1:** Categorization of cloud-based games based on a subset of objective game characteristics for the purpose of assigning different QoE-driven video encoding adaptation strategies to different game categories.
- **C2:** Empirically derived QoE models for the proposed game categories which quantify the relationship between QoE and video encoding parameters for different game categories.
- **C3:** Proposed QoE-driven video encoding adaptation strategies based on derived QoE models and evaluated in a case study involving QoE optimization under variable network resource availability constraints.

1.5 Thesis structure

The remainder of the thesis is structured as follows. Chapter 2 describes the cloud gaming paradigm and its architecture, and gives a brief overview of state-of-the-art cloud gaming platforms. Following the review of state-of-the-art literature and standards (Chapter 3, Chapter 4 reports on the results of two empirical studies (Studies S1 and S2) that investigated the impact of network parameters on user's QoE for cloud gaming, and video streaming adaptation strategies implemented in a commercial cloud gaming solution. Further, Chapter 5 describes four subjective QoE studies that examined the impact of video encoding parameters (namely bitrate and frame rate) on end user QoE under bandwidth constraints. Based on the results of conducted studies in Chapters 4 and 5, in Chapter 6 of the thesis we propose a novel game categorization for cloud gaming based on objective video metrics and gameplay characteristics. The categorization is then utilized in the following Chapter 7 for deriving appropriate video encoding adaptation strategies for cloud gaming. In Chapter 8, performance of the proposed QoE-driven video encoding adaptation strategies is evaluated in a case study based on numerical evaluation. We consider different numbers of cloud gaming players simultaneously accessing a bottleneck link, and compare different resource allocation algorithms and adaptation strategies in terms of achievable MOS and bitrate. Finally, in Chapter 9 we once again summarize the main contributions of the thesis in the context of the specified research questions, and provide a discussion of limitations of the thesis and outlook for future work.

Chapter 2

Cloud gaming: architecture & platforms

Section 2.1 describes the cloud gaming paradigm and presents key components of a cloud gaming architecture. Section 2.2 covers video encoding and streaming, while pros and cons of cloud gaming are listed in Section 2.3. Finally, in Section 2.4 an overview of existing cloud gaming platforms (as of 2020) is given.

2.1 Cloud gaming architecture

Cloud gaming is a type of online gaming that allows on-demand streaming of game content onto non-specialized devices (e.g., PC, tablet, smart TV, etc.), as shown in Figure 2.1. The game content is delivered from a server to a client in the form of a video stream, with game controls sent from client devices to the server [3]. Resource-heavy tasks (the execution of the game logic, rendering of the 2D/3D virtual scene, and video encoding) are performed at the powerful server, while the lightweight client simplifies client-side setup and is responsible only for executing the necessary tasks at the client (video decoding and capturing of client input).

The typical deployment process of a cloud gaming service consists of several steps [3, 40, 41]. A cloud gaming platform is first deployed on a cloud infrastructure, residing in a single or multiple data centers. The cloud gaming provider, in cooperation with the game developers,

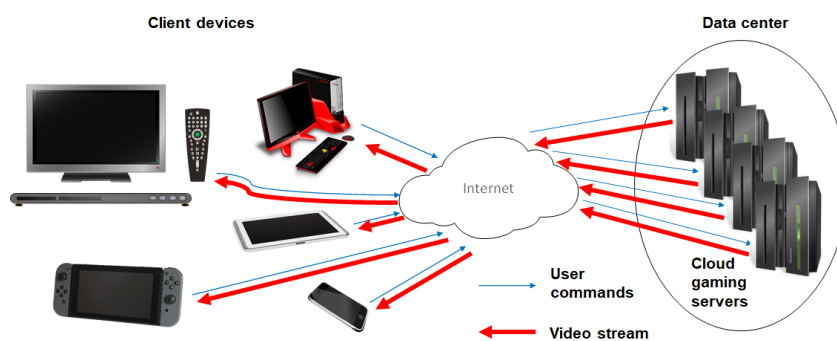

Figure 2.1: Cloud gaming service

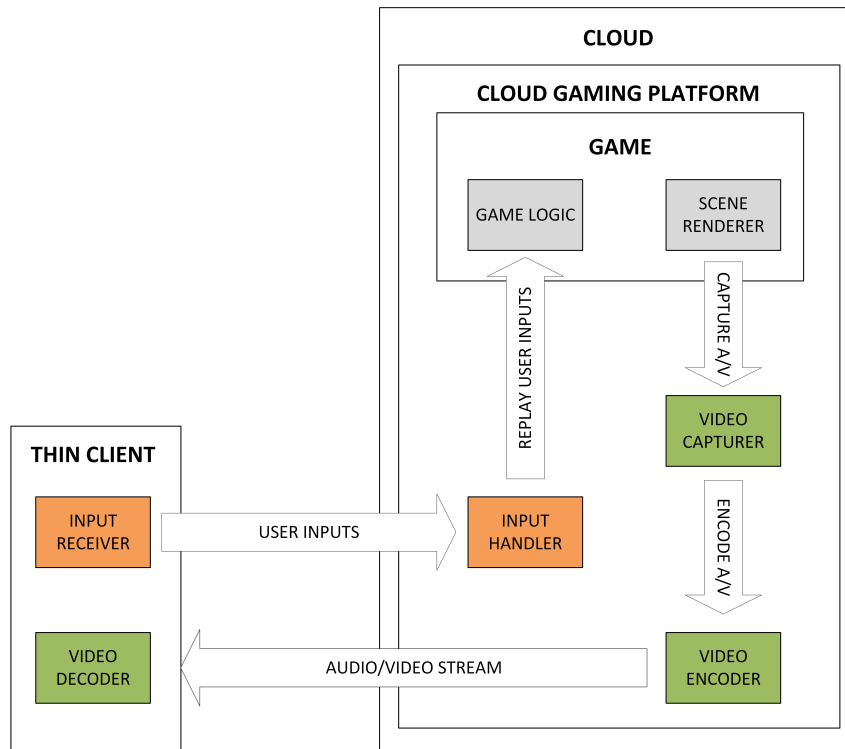

Figure 2.2: Cloud gaming architecture adopted from [3]

decides which games will be available on the deployed cloud gaming platform. Chosen games are then downloaded and installed on the server(s). After initial deployment, a user selects a game from the list of available games and is assigned to a cloud gaming server (located in a data center). Consequently, the game is launched on the server. Once the game is launched, capturing of audio/video frames of the game’s rendered virtual scene starts on the server, which are immediately encoded using selected audio/video codecs, as illustrated in Figure 2.2. The encoded frames are then delivered to the so-called thin client via an Internet connection. The term *thin client* is used when referring to cloud gaming clients, as their only responsibility is to perform simple tasks: decode and display incoming audio/video streams, and capture and send user input (user controls entered using a mouse, keyboard or other input device) to the server. Finally, the server replays received user input and forwards it to the game that renders a new virtual scene.

2.2 Video encoding and streaming

Online gaming is an example of a highly dynamic and interactive online service with strict real-time network requirements. Responsive gameplay requires a latency of 150 ms or less for games that are highly sensitive to latency, such as First Person Shooters [33, 42]. Hence, video streaming in cloud gaming requires continuous game content to be presented to end users without any interruptions in content flow. Video content must be encoded and streamed to end-users

in the shortest available time. In “normal” live media streaming, the service provider may increase data compression by configuring the video codec in such a way that it delays the video stream. Modern standards for video encoding specify a group of pictures (GOP) as a set of successive frames in a coded video stream, that can be decoded independently. A GOP can contain I-frames (intra coded frames coded independently of other frames), P-frames (predictive coded frames coded relative to previously decoded frames), and B-frames (bi-directionally coded frames coded relative to the past frames or future frames). The size of coded video frames decreases as more previous (and future) information is used to predict a new coded frame (usually P-frame size is around 30%-45% the size of an I-frame, while B-frames are typically around 15%-30% the size of an I-frame [43, 44]). Therefore, the highest compression ratio can be achieved by using a large GOP with a lot of B-frames. However, this introduces additional encoding delay, as to decode B-frames the decoder also uses future reference frames from the GOP. In the case of cloud gaming, smaller GOP sizes without B-frames have been used to minimize encoding delay [41]. Furthermore, “normal” live media streaming services, such as Twitch, Netflix and YouTube Live, utilize client-side buffering to combat network impairments (such as congestion leading to packet loss or jitter). As a consequence of being a highly interactive service, cloud gaming streams can not rely on client-side buffering (as that would result in unresponsive gameplay), thus leading to cloud gaming being very sensitive to packet loss and jitter [23, 45].

With regards to the used video codecs, the H.264/AVC video codec [46] is employed by most of the cloud gaming platforms available at the market as of 2020. According to the report [47], as of 2019, the H.264 video codec is still the most popular video format in the world, having 82% of the market share of video on demand (VOD) services. A similar trend is observed for cloud gaming, as only a few cloud gaming companies utilize H.265/HEVC video codec [48] for video encoding, mostly of 4k game streams. Even though H.265 provides higher compression ratio compared to H.264, increased latency while decoding the video is observed in a lot of consumer hardware [49], thus preventing a major switch to H.265 video codec in cloud gaming.

With respect to network protocols used to deliver the cloud gaming service, nearly all available cloud gaming platforms use the User Datagram Protocol (UDP) for streaming the game content to end-users. The Transmission Control Protocol (TCP) was used by a small number of cloud gaming platforms, and only in a early development stages [50], or for testing purposes [41]. As the congestion control algorithm implemented in the TCP protocol handles the packet loss by adding a lot of latency, the TCP protocol is not suitable for such highly interactive service as cloud gaming.

2.3 Cloud gaming benefits and drawbacks

Cloud gaming has several benefits compared to “traditional” online gaming. It reduces client’s hardware requirements by a large margin, thus allowing the delivery of graphically-rich games to less powerful client devices. Another benefit is that there are no constraints based on the end device’s hardware capabilities or operating system, alleviating game developers of the need to develop customized versions of a game for different platforms, and enabling end users to play games on almost any device capable of displaying video content. As the increase in game download sizes over the last few years (rising up to more than 140 GB of hard disk space [51]) made some games less accessible, cloud gaming offers no download or game installation, given that the actual game is stored and executed on the remote server and only its output is streamed to the client. This fact also results in almost instant game access. Finally, as the game content is stored in the cloud and is only distributed in the form of video stream to the clients (i.e., clients do not have a copy of the game), game developers and providers have complete control over the game content, thus making game piracy virtually impossible [3, 52].

Despite numerous advantages, there are still issues and challenges that persist and currently hinder the wide market adoption of cloud gaming. As has been mentioned previously, on-line gameplay is a highly interactive service with strict real-time requirements. Hence, video streaming in cloud gaming, as in other interactive online applications, requires continuous game content to be presented to end users without any interruptions in content flow. Meeting latency requirements becomes very challenging, with the need to calculate game state, render the virtual scene, and encode/decode the video stream. While such a game streaming paradigm significantly reduces the end client device requirements as compared to “traditional” online gaming, it also significantly increases the network requirements necessary to secure a good level of QoE (e.g., Nvidia’s GeForce NOW requires an RTT (round trip time) from client to the server lower than 60 ms [53]), which will be described in more detail in the following chapter.

2.4 Cloud gaming platforms

Cloud gaming architectures can be categorized into cloud gaming and in-home game streaming based on the streaming server’s location. *Cloud gaming* involves streaming games over a broadband Internet connection from servers located in the cloud to practically any video-enabled device, with GeForce Now [6] and PlayStation Now [5] as examples of commercial cloud gaming solutions. On the other hand, *in-home game streaming* involves streaming of video games from a personal device (PC, gaming console) to other devices in a home local network, including mobile devices and other mobile gaming consoles. For example, this approach is applied in Sony’s Remote Play service [9], in which the game content is streamed from the PlayStation 4 console

to PlayStation Vita handheld device, and in Valve's Steam In-Home streaming (later renamed to Steam Remote Play) [10] service for the PC gaming platform Steam. In-home game streaming implies video streaming of the game content in a local area network (LAN) via a wired/wireless connection, thereby mitigating one of the major concerns related to cloud gaming – network limitations.

Adaptive cloud gaming solutions continuously monitor network conditions and can adjust the video quality according to given limitations, or deny the service if the minimum requirements cannot be met [38]. In LANs, network delays are very low and available bandwidth is very high, even for wireless networks (e.g, the new IEEE 802.11ac standard offers theoretical speeds up to 6933 Mbit/s). Therefore, in-home streaming approaches are designed to deliver gaming experiences which are unspoiled by poor network conditions. It must be noted that even though in-home streaming solutions were primarily designed for streaming in LANs, with improved network performance and streaming technologies, most of them have lately added support for streaming over a broadband Internet connection, similar to “common” cloud gaming (e.g., Steam's Remote Play [10]).

Listed below in Table 2.1 is an overview of cloud gaming platforms, from early cloud gaming platforms available on the market, to the latest state-of-the-art commercial cloud gaming services available at the time of this writing. In the scope of this thesis, GamingAnywhere [41] was used in the study investigating the impact of network parameters on user's QoE (see Section 4.1), NVIDIA's GeForce NOW was used to analyze and evaluate the service adaptation mechanism implemented in the commercial product (see Section 4.2), and Steam Remote Play was used in the studies that tested the impact of video encoding parameters on QoE (see Chapter 5).

All cloud gaming platforms listed in Table 2.1 support playing games at 60 fps. With regards to Internet requirements, the platforms recommend 5 Mbps to 10 Mbps for 720p [5, 54, 55, 56, 57, 58, 59], 15 Mbps to 30 Mbps for 1080p [7, 9, 10, 60, 61, 62], and 35 Mbps to 70 Mbps for 4k [7, 10, 63]. Most of the listed platforms use the UDP protocol for streaming, and the H.264 video codec for encoding of the game content. OnLive [54], Gaikai [55], Playstation Now [5], GeForce NOW [60], Vortex [57], Shadow [63], Stadia [7], Xbox Game Pass [59], and Project Atlas [62] offer streaming over Internet connection from their servers, Playstation Remote Play [9], GameStream [64], Parsec [56], Remotr [58], and Rainway [61] are designed for in-home streaming, while GamingAnywhere [41] and Steam Remote Play [10] offer both.

Further details about mentioned cloud gaming platforms are given in the following subsections.

Table 2.1: Overview and comparison of cloud gaming platforms, indicating market availability.

Cloud gaming service	Owner	Available	Host	Client	Recommended Internet connection speed	Game Library	Pricing plan	Maximum stream output
OnLive [54]	OnLive	2009 - 2015	OnLive servers	Windows, Android, macOS, TVs	5 Mbps	OnLive library	monthly fee	720p@60fps
Gaikai [55]	Gaikai	2011 - 2012	Gaikai servers	Windows, Android, TVs	5 Mbps	Gaikai library	free	720p@60fps
GamingAnywhere [41]	open-source	2013 -	User hardware	Windows, Android	3 Mbps or higher	User library	free	Any (in theory)
Steam Remote Play [10]	Valve	2014 -	User hardware	Windows, Android, iOS, Rapsberry Pi	50 Mbps for 4k, 25 Mbps for 1080p	User library	free	4k@60fps
Playstation Now [5]	Sony	2014 -	Sony's servers	PS4, Windows	5 Mbps or higher	Playstation library	monthly fee	4k@60fps
Playstation Remote play [9]	Sony	2014 -	User's PS4	Windows, Android, iOS, macOS	15 Mbps	User library	free	1080p@60fps
GeForce NOW [60]	NVIDIA	2015 -	NVIDIA's servers	Windows, Android, macOS, SHIELD TV	25 Mbps for 1080p	User library	monthly fee	4k@60fps (SHIELD) 1080p@60 (others)
Parsec [56]	Parsec Gaming	2016 -	User hardware	Windows, Android, macOS, Ubuntu, Rapsberry Pi	10 Mbps	User library	free	1080p@60fps
Vortex [57]	RemoteMyApp	2017 -	Vortex's servers	Windows, Android, macOS	10 Mbps	User library	monthly fee	720p@60fps
Remotr [58]	RemoteMyApp	2017 -	User hardware	Windows, Android, iOS	10 Mbps	User library	free	720p@60fps
Rainway [61]	Rainway Inc.	2018 -	User hardware	Windows, Android, iOS	15 Mbps	User library	free	1080p@60fps
Shadow [63]	Blade	2018 -	Blade's servers	Windows, Android, macOS, iOS,TVs	70 Mbps for 4k 25 Mbps for 1080p	User library	monthly fee	4k@60fps
Stadia [7]	Google	2019 -	Google's servers	Chrome, Chrome OS, Chromecast Ultra, Android	35 Mbps for 4k, 20 Mbps for 1080p	Stadia library	monthly fee	4k@60fps
Xbox Game Pass [59]	Microsoft	2020-	Microsoft's servers	Android	10 Mbps	Xbox library	monthly fee	720p@60fps
Project Atlas [62]	EA	TBA	EA's servers	Windows, macOS, Android	30 Mbps	EA's library	TBA	1080p@60fps

OnLive

OnLive [54] was one of the first commercial cloud gaming platforms that offered game streaming by delivering game content from the server to the client in the form of a video stream [54]. Presented to the public in 2009, it required an Internet connection of 1.5 Mbps for 480p and 5 Mbps for 720p resolution. OnLive used Real-time Transport Protocol (RTP)/UDP protocols for streaming video flows to the client [65]. At the time, it offered a unique service of playing new, graphic intensive games on outdated and low-cost hardware. However, it was reported that the service was never truly accepted by “hardcore” gamers as it did not offer a *full game experience*, i.e., game streaming at 1080p with 60 fps[66]. Subsequently, this led to closure of the service in 2015, and Sony acquiring most of its assets and patents.

Gaikai

Unlike the OnLive service, which initially required its own proprietary client, Gaikai’s streaming service from the start did not utilize a custom client. Its technology was implemented as a plugin (Java or Adobe Flash plugin) or was a part of another service (e.g., integrated in Facebook, smart devices or TVs). Gaikai recommended an Internet connection of 5 Mbps or faster, with 3 Mbps stated as being the minimum requirement [55]. In 2012, Sony Computer Entertainment announced it acquired the Gaikai cloud gaming service, which later resulted with two Sony cloud gaming products: Remote Play and PlayStation Now.

GamingAnywhere

GamingAnywhere (GA) [41] is an open source cloud gaming platform enabling researchers to perform experiments and studies on real-time streaming of video games in the cloud. GA delivers the video streaming using RTP/RTCP (RTP Control Protocol) over UDP or TCP. The advantage of conducting studies using the GA platform is the possibility to reconfigure (e.g., altering a variety of streaming parameters) and customize (e.g., adding support for new video codecs) the GA platform, which is impossible whilst using commercial solutions and closed cloud gaming platforms. Besides streaming games to Windows PCs, GA supports Android devices as end-user clients.

Valve’s Steam Remote Play

Steam Remote Play (formerly known as Steam’s In-Home Streaming) is Valve’s commercial cloud gaming platform intended for streaming games from a powerful PC to other weaker devices such as laptops or tablets [10]. First iterations of Steam Remote Play supported resolutions up to 1080p and only supported streaming in a local network, while more recent iterations come

with 4k support and enable streaming across the Internet (not limited to local networks). Default bandwidth requirements for 1080p resolution are 15 Mbps, and the recommended speed is 30 Mbps. Steam Remote Play uses the UDP protocol for both downstream and upstream traffic, while the video is encoded with the H.264 video codec [67]. One of the features of Steam Remote Play is that the user can customize streaming settings, such as target bitrate, resolution, and frame rate, making the service appropriate for conducting experiments in a controlled environment.

Sony's PlayStation Now and Remote Play

Acquiring Gaikai's streaming service and obtaining most of OnLive's patents has given Sony significant advantage over competitors at designing, improving, and delivering a functional game streaming service to customers [5]. PlayStation Now was announced in 2014 and open beta was available later the same year. As of 2020, PlayStation Now offers users unlimited access to a library of PS2, PS3 (as a way of enabling backward compatibility with games released in previous iterations of the PlayStation console) and PS4 games that can be streamed to PS4 or a PC. Playstation Now uses the H.264 video codec, and the UDP protocol for both downstream and upstream connections [36]. Sony recommends a broadband connection ranging from 5 to 12 Mbps. Another streaming service provided by Sony is Remote Play [9]. Remote Play is an in-home streaming type of service that lets users stream their PS4 games to a desktop PC, laptop or any mobile device in a local network. Sony recommends at least 15 Mbps Internet connection to have unimpaired gaming experience.

NVIDIA's GeForce NOW and GameStream

GeForce NOW is the commercial product of the NVIDIA company, available on the market as of 2015 [60]. It uses the RTP over UDP to deliver video content [29] which is encoded using the H.264 and the H.265 video codecs. GFN first started as a gaming-on-demand service that connects players to NVIDIA's cloud-gaming supercomputers and enables them to stream selected PC games to a SHIELD device at up to 1080p resolution and 60 fps. However, as of 2020, it enables users to stream any game (purchased on any game distribution service) to their own PCs. GFN requires at least 15 Mbps for 720p at 60 fps and 25 Mbps for 1080p at 60 fps. Similar to Sony's and Valve's cloud gaming platform, NVIDIA also provides GameStream service [64], an in-home streaming type of service that lets users stream their PC games to NVIDIA's SHIELD TV or SHIELD tablet at up to 4k HDR (High-dynamic-range) with 60 fps.

Parsec

Parsec is a cloud gaming platform developed by Parsec Gaming and initially released in 2016 [56]. Parsec started as most the other cloud gaming platforms, providing streaming of video games from virtual PCs hosted by cloud web services. Later, its business model changed to license developed streaming technology to other enterprises (e.g., partnering with HP in 2018 resulted with the OMEN Game Stream cloud gaming service only available to owners of specific models of HP laptops [68]). Additionally, they offer innovative P2P cloud gaming match-making service where they connect players that host video games on their personal PCs with client players willing to play cooperatively with hosts. Hosting is only available with Windows OS 8.0+, while clients can connect from a variety of devices, such as Windows PCs, Ubuntu desktops, macOS devices, Android phones and Raspberry Pi. Reportedly, the video stream at 720p@60fps uses 5 Mbps, while for 1080p@60fps it requires 10 Mbps. Parsec uses own proprietary networking protocol over the UDP protocol [50].

Vortex and Remotr

Vortex is a cloud gaming platform owned by the Poland-based company RemoteMyApp [57]. Users can access the service from varieties of client devices, including Android mobile phones, Windows PC and macOS devices. Vortex requires from the users to own the game to play it, however there is an assortment of free-to-play games offered in the Vortex library. Also, in order to play any of the games, an active paying subscription is necessary (with pricing from 9.99 to 27.99) that additionally limits user's playtime per month from 50 hours to 140 hours (depending on the selected price plan). Vortex requires 10 Mbps Internet connection for 720p@60fps. Another cloud gaming service provided by RemoteMyApp is Remotr [58], a streaming service that lets users stream games from a personal PC to any Android, iOS and Windows mobile phone, and Windows PC. Instead of renting a virtual PC (as in the case of Vortex), users can install Remotr on a powerful PC and access their games from anywhere and at anytime. Similarly to Vortex, Remotr requires 10 Mbps downlink speed for streaming games at 720p@60fps.

Rainway

Rainway is a cloud gaming service [61] that, similarly to Steam Remote Play and Remotr, offers users the ability to stream PC games from their own personal PCs to Windows PCs with the Chrome browser, and iOS and Android mobile devices. Encoded 1080p@60fps video (maximum quality) is streamed using a technology based on the WebRTC (Web Real-Time Communication) framework, commonly used for real-time communication for the web [69].

On the service website, the suggested downlink connection speed for low quality streaming is 5 Mbps, while for high quality the suggested speed is 15 Mbps.

Shadow

Shadow is a cloud gaming service announced in France in 2017 [63]. Similar to the latest iteration of GeForce NOW, Shadow essentially lets users rent a powerful PC capable of playing the most graphic-intensive modern games, making the service a high powered remote desktop. Shadow supports essentially any device capable of displaying video content, with the Shadow application installed on it. It is recommended to have at least a 25 Mbps Internet connection, however the user can set the bitrate to between 5 Mbps and 70 Mbps. It uses the UDP protocol for streaming game content which is encoded using the H.264 and the H.265 video codecs.

Google's Stadia

Stadia is Google's cloud gaming platform launched in November 2019 [7]. According to Google, Stadia requires an Internet connection of 10 Mbps for streaming 720p@60fps, 20 Mbps for 1080p@60fps and 35 Mbps for 4k@60fps [70]. Besides access to high-speed Internet, a compatible controller (an Android device with Stadia's app) and a device with Chrome support (laptop or PC with Google Chrome, or TV with Chromecast Ultra device) is necessary. Stadia uses Google's QUIC (Quick UDP Internet Connections) protocol, and the H.264 and the VP9 (for 4K video resolution) video codec.

Microsoft's Xbox Game Pass cloud gaming

Xbox Game Pass cloud gaming (formerly known as Project xCloud) is Microsoft's cloud gaming service announced at the end of 2018 [59]. For now, Xbox Game Pass cloud gaming is centered on exclusively delivering Xbox game content to Android mobile phones or tablets with Bluetooth support necessary for pairing with the Xbox wireless controller. Microsoft specifies that its service requires 10 Mbps download speed, inline with their goal of delivering unspoiled gaming content using minimal bitrate to a wide range of end-user devices. It uses the UDP protocol for game streaming.

EA's Project Atlas

In late 2018, another proof of the shift of cloud gaming from being just a buzzword to being a relevant trend emerged, as gaming Giant EA announced their own cloud gaming platform, Project Atlas [62]. At the moment, there is little information available about technical implementation and requirements, however the company stated that *[they] are developing software*

that utilizes the cloud to remotely process and stream blockbuster, multiplayer HD games with the lowest possible latency, and also to unlock even more possibilities for dynamic social and cross-platform play. In September 2019 EA launched a technical test of Project Atlas, allowing testers to play selected games on tablets, Windows PC and macOS devices [71]. Reportedly, Project Atlas will require 5 Mbps connection for 480p and 30 Mbps for 1080p video streaming.

2.5 Chapter summary

The cloud gaming paradigm, along with key architectural components, has been presented in this chapter. Furthermore, an overview and comparison of the most relevant cloud gaming services and platforms was provided. A decade ago, existing cloud gaming services and platforms did not have any major technical implementation flaws, however existing system and network infrastructures were unable to meet the strict network requirements of such a highly interactive online service. However, with the rise of mobile gaming and the planned deployments of 5G networks providing low latency and high throughput, the cloud gaming paradigm has once again become a popular gaming trend. Most of the largest gaming and technological companies have identified cloud gaming as a promising tool for their market expansion of existing gaming services, and have started to make available cloud gaming services for public testing.

Chapter 3

State of the art review: Quality of Experience assessment and modeling for cloud gaming

Following the overview of cloud gaming platforms and characteristics given in the previous chapter, this chapter focuses on Quality of Experience assessment and modeling for cloud gaming services. In Section 3.1, we first describe the general concept of QoE, and give an overview of QoE assessment methods. Section 3.2 then addresses challenges related to assessing QoE for online gaming. Finally, in Section 3.3 we give an overview of studies addressing specifically QoE for cloud gaming.

3.1 Quality of Experience

QoE as a concept has been defined in various ways [72, 73, 74, 75], with the common conception being that it provides a subjective measure of the quality of a user's experience when using a given service. Studies focusing on QoE are commonly considered to have originated in the field of telecommunications as a step beyond Quality of Service (QoS), by focusing on subjective user perception. The standards body ITU-T (International Telecommunication Union – Telecommunication Standardization Sector) in Recommendation E.800 [76] defined QoS as “*the collective effect of service performance which determine the degree of satisfaction of a user of the service*”. As stated in the recommendation, QoS evaluates end-user satisfaction with the service based on the service's technical characteristics and opinion ratings expressed by the user, at the same time disregarding a significant number of other subjective factors that could also have an impact on user perceived quality of the service. Even though, according to the definition given by ITU-T, QoS should have been user centered, the studies in this area were mostly focused on investigating the impact of technical parameters on QoS [77]. At that time,

QoS studies in the telecommunications area were primarily focused on investigating the impact of network parameters and objective characteristics of provided services, such as latency, packet loss, ways of encoding data, etc.

3.1.1 Definitions

Back in 2001, Moorsel [72] referred to the concept of Quality of Experience as a novel metric related to user experience while using a telecommunication service. The author points out that QoE differs from traditional QoS in terms of subjective influences on the user, which can not be measured by QoS. Shortly after, the interest in QoE assessment and modeling spread rapidly in the research community, resulting in many attempts to (re)define the notion of QoE. The standards body ITU-T thus extended Recommendation E.800 [76] by defining Quality of Service as the “*totality of characteristics of a telecommunications service that bear on its ability to satisfy stated and implied needs of the user of the service*”, and emphasized the importance of QoS perceived by the user. At the same time, ITU-T in an extension P.10 of Recommendation G.100 defined QoE as “*the overall acceptability of an application or service, as perceived subjectively by the end-user*”, while the standards body ETSI defined QoE as a “*measure of user performance based on both objective and subjective psychological measures of using an ICT service or product*” [74]. Several authors [78, 79, 80, 81, 82] also have touched on this topic and presented various definitions of QoE. At the time of this writing, the most widely referenced definition is the one proposed by the European Network on Quality of Experience in Multimedia Systems and Services (QUALINET) that states “*Quality of Experience (QoE) is the degree of delight or annoyance of the user of an application or service. It results from the fulfillment of his or her expectations with respect to the utility and / or enjoyment of the application or service in the light of the user’s personality and current state.*” [75]. Based on these works and contributions, it can be observed that there has been a shift in perspective from QoS as a technical orientated concept to QoE as a multidimensional, user-centered concept [83]. Thus, in addition to system-related factors (such as the technical performance of a given service), there is a need to take into consideration context (e.g., time, location, etc.) and human factors (e.g., expectations, experience, etc.), resulting with a complex QoE ecosystem, as depicted in Figure 3.1.

3.1.2 QoE assessment methods

QoE assessment methods investigate the influence of factors affecting QoE. Two general approaches for QoE evaluation are subjective and objective QoE assessment [84].



Figure 3.1: QoE ecosystem as reported in [80]

Subjective assessment

Subjective QoE assessment can be conducted in a number of different ways, the most common being user questionnaires and subjective tests that are usually conducted in a controlled laboratory environment. Parameter manipulation and control can give detailed insight into the impact of tested parameters on user’s QoE. As such assessments are repeatable, the results of the conducted studies may be confirmed by conducting the experiments multiple times. However, this type of QoE evaluation has several disadvantages. Real-world conditions often do not match those of the test environment, which could result with unreliable research results. Furthermore, subjective assessment in a controlled environment is often time consuming and expensive, usually resulting in a limited number of test participants. For that reason, crowdsourcing provides the means to reach a larger test population, while reducing the time and the cost of the research [85, 86, 87, 88].

Most commonly, QoE subjective assessment studies report Mean Opinion Scores (MOS) [89] to quantify QoE, which can be determined by averaging the ratings of all test participants for the same test conditions. However, the MOS does not give proper insight into the distribution of user ratings. Users may have different interpretations of the rating scale (e.g., it may occur that two users with different experiences provide the same ratings). In addition to reporting only MOS scores, recent work has advocated the benefit of reporting additional metrics beyond MOS (such as ratio of users scoring good or better, or ratio of users scoring poor or worse [90]) so as to provide insight into rating distributions and user diversity [91].

Objective assessment

The subjective nature of QoE makes it difficult to quantify the quality of service, as the users most commonly express (dis)satisfaction through qualitative descriptions such as *good*, *bad*,

excellent, etc. Even the users sometimes are unable to qualitatively describe the satisfaction with the service. For this reason, QoE is often evaluated using estimation models and objective measurements. The reliability of the QoE assessment through objective measurements heavily depends on the quality of the approximation model for a particular type of service. To develop a reliable model for QoE assessment, measurable parameters that affect users' QoE are required. These parameters affect different parts of the service and they differ for different services. Examples of parameters that have impact on QoE are network and service parameters, context, user expectations, and previous user's experience.

A number of research papers have focused on determining and categorizing QoE influence factors. The ITU standardization body proposed categorization of influence factors into objective and subjective factors, where objective factors relate to quality of service (e.g., service and network parameters), while subjective factors are linked to human factors (e.g., emotions and past experiences) [92]. Möller *et al.* [93] gave a systematic overview of influence factors on QoS and QoE of human-computer interaction (HCI). They define three groups of influence factors, depending on the part of the service they relate to: user factors (all user characteristics that have an impact on user's subjective perception of the service quality), system factors (all system characteristics that have an impact on user's QoE), and context factors (existing environment and system factors while using the service). The previously cited QUALINET whitepaper [75] also groups QoE influence factors into the following categories: human-, context-, and system-related.

3.2 Assessing QoE for online gaming

Over the past years there have been significant research efforts in the domain of online gaming aimed at studying the relationships between end-user QoE and various network, service, and context factors. Möller *et al.* [94] proposed a detailed taxonomy of gaming QoE aspects, aimed at providing a generic evaluation framework. They identified the following three layers relevant for gaming: QoS influence factors (related to the user, system, and context); user and system interaction performance aspects; and finally QoE features related to the end user quality perception and judgment processes.

3.2.1 Online gaming QoE aspects

Möller *et al.* [94] classify influence factors for online gaming as the following:

- *user factors*: experience, playing style, intrinsic motivation, static factors (e.g., age, gender), and dynamic factors (e.g., emotional status),
- *system factors*: game genre, structure, game mechanics and rules, technical set-up (including server, transmission system, interface software, and device characteristics), and

- *context factors*: physical environment, social context (e.g., relation to other players involved), extrinsic motivation, and service factors (e.g., access restrictions, gaming cost).

Even though influence factors were identified, challenges remain with respect to evaluating their impact on gaming QoE, due in part to the lack of unambiguous definition (of the factors) and reliable evaluation methods. With regards to user factors, player's gaming experience has been predominantly investigated in previously conducted user studies. However, player experience is highly difficult to assess, and in most of the user studies the participants perform self assessment of their previous gaming experience via questionnaires. Consequently, players are often classified into experience groups based on their reported playing time per week [14, 15, 95]. (e.g., experienced gamers with more than 9h of playing time per week, casual gamers with less than 9h).

In the case of system factors, game genres and technical factors have been mainly investigated. While there are traditional game genre-based categorizations, and certain scientific approaches in categorizing games (e.g., based on camera perspective [16]), formally recognized game categorization is missing. With respect to technical factors, the impact of network and system parameters (such as network bandwidth, packet loss, latency, resolution, graphic details) on QoE have been researched for many year. We specifically discuss the findings relevant for cloud gaming QoE in the next section.

Finally, context factors are highly dependent of the tested game and the context in which the game is being played. Physical environment factors include the characteristics of surroundings (such as lightning, position in the room, sound environment, etc.) and usage context (mobility, in-home, commute, etc.), which are predominantly investigated for mobile gaming [96, 97]. Besides physical environment, social context as group composition of differently experienced players was analyzed in some of previous studies [15, 21].

Interaction performance aspects for gaming include performance aspects of the system and the user [94]. System performance includes the performances of the following: the user interface (the input and the output performance of the user interface), the back-end platform (performance of handling of user input and generating following output), the game (user control over game and game responsiveness), and any communication channels (e.g., performance of forwarding user input to the game and generating output back to the user). With regards to the user performance, it includes perceptual effort (identification of relevant system information), cognitive workload (necessary working memory resources for the gaming task), and physical response effort (physical effort to play and interact with the game).

The given influence factors impact system and user performance resulting from player interaction with the system, and are finally linked to the following quality features (dimensions) [94]: interaction quality, playing quality, aesthetic aspects, overall player experience, and acceptability. Interaction quality of a game is linked to playability of the game, and it includes

input and output quality, as well as the interactive behavior. Playing quality (enhanced game usability) addresses game sub-aspects learnability and intuitivity, while aesthetic aspects include also system personality and appeal. As previously proposed by Poels *et al.* [98], player experience may be considered in terms of the following sub-aspects: flow, challenge, control, tension, immersion, positive and negative affect. Finally, acceptability is a measure of sufficiency of the system for the purpose of gaming.

3.2.2 QoE assessment methods for online gaming

Subjective quantitative assessment methods that use standardized 5 pt. or 7 pt. Absolute Category Rating (ACR) scales to obtain MOS are most commonly used to evaluate QoE for games [14, 15, 22, 35, 95, 99, 100, 101, 102, 103]. The questionnaires are filled in at the end of each test scenario. Ijsselsteijn *et al.* [98] proposed the Game Experience Questionnaire (GEQ) that estimates user experience based on 7 user experience components: immersion, flow, competence, positive and negative effect, tension, and challenge. Due to its size of 42 questions, the GEQ questionnaire is considered not suitable for some studies, as the filling in the questionnaires takes a considerable amount of time, possibly resulting with a loss of user focus while playing. Unlike previously mentioned quantitative assessment methods, Appelman [104] used a qualitative logging method to describe emotions and events that have occurred while playing - *Game Play Analysis Log*. Besides subjective methods for game QoE assessment, objective methods for assessing the player's gameplay experience via devices for measuring psychophysical stimuli are lately often used in QoE studies [19, 24, 105, 106, 107]. Facial electromyography is a method for measuring the muscle activity by detecting electrical impulses that generate muscle fibers during narrowing. It is mostly focused on two facial muscle groups that are associated with frowning and laughing. Similarly, excitement during playing can be also detected by measuring electrodermal activity (also known as galvanic skin response) [108, 109], i.e., nervousness can be detected by measuring conductivity of the skin.

3.2.3 Standardization

With respect to standardization activities, Study Group 12 of the International Telecommunication Union (ITU-T SG12) defined three recommendations related to the assessment and modeling of online gaming QoE: Recommendation ITU-T G.1032: "Influence factors on gaming quality of experience" [110], Recommendation ITU-T P.809: "Subjective evaluation methods for gaming quality" [111], and Recommendation ITU-T G.1072: "Opinion model predicting gaming quality of experience for cloud gaming services" [112]. Given their relevance to the topic of this thesis, we give a brief overview of each of the three recommendations.

Recommendation ITU-T G.1032: “Influence factors on gaming quality of experience”

Recommendation ITU-T G.1032 [110] is mainly based on the gaming taxonomy [94] previously described in this section, and lists factors that may have an impact on online gaming QoE. Relevant influence factors are categorized for three different types of consuming gaming content: passive viewing-and-listening, interactive online gaming, and interactive cloud gaming. Based on the test paradigm, some of the factors may have significant impact on gaming QoE, while the others are inconsequential for that paradigm. Influence factors are categorized as the following:

- *human influence factors*: experience with gaming in general, experience with a specific game or genre, intrinsic and extrinsic motivation, static (e.g., age, gender, native language) and dynamic (such as boredom, curiosity, etc.) human factors, and human vision,
- *system influence factors* further divided into:
 - game - game genre and mechanics, temporal (time required to complete an action) and spatial accuracy (the degree of accuracy required to perform an action successfully), pace (gameplay dynamics), visual perspective of the player (game camera perspective), aesthetics and design characteristics, and learning difficulty,
 - playing device - portability (mobility), size, input and output modalities, and display characteristics,
 - network transmission - delay, jitter, bandwidth and packet loss,
 - compression - frame rate, resolution, rate controller modes (constant quantization parameter (CQP), constant rate factor(CRF), and constant bitrate (CBR)), group of pictures (order of inter and intra frames (I, P and, B frames) in a video sequence), motion range search (for motion estimation), and audio compression,
- *context influence factors*: physical environment, social context, service factors, and novelty.

In the scope of this thesis, we investigate the impact of the following influence factors on QoE:

- delay and packet loss (Studies S1 and S2),
- frame rate and bitrate (Studies S3-S6),
- game genre (Studies S2-S6),
- player experience (all studies, except Study S2), and
- social context (Study S4).

Recommendation ITU-T P.809: “Subjective evaluation methods for gaming quality”

Recommendation ITU-T P.809 [111], published in 2018, lists quality features of gaming QoE, as reported in [94], which were previously described in this section, and are shown in Figure

3.2. Additionally, general guidelines for subjective assessment of gaming quality are provided, from test paradigms and experimental set up to types of questionnaires for QoE assessment. Online gaming, as in other interactive online applications, requires continuous game content to be presented to end users without any interruptions in content flow. Consequently, obtaining user feedback (e.g., via questionnaires) on gaming quality without interrupting their playing activity and disturbing the flow and immersion is a highly difficult task, and these interruptions should be kept at a minimum. Usually, test participants are asked to play a set of controlled game scenarios, and to provide quality ratings after each test scenario, as visualized in Figure 3.3. The duration of a test scenario (playing game scene under different test conditions) usually depends on the selected scene (consequently implying it also depends on the selected game), and limits the number of test conditions that could be investigated during a gaming session. Furthermore, QoE is heavily influenced by the test platform, therefore a standardized game platform should be defined, so that research could be repeated, and the effects and results in different user studies compared.

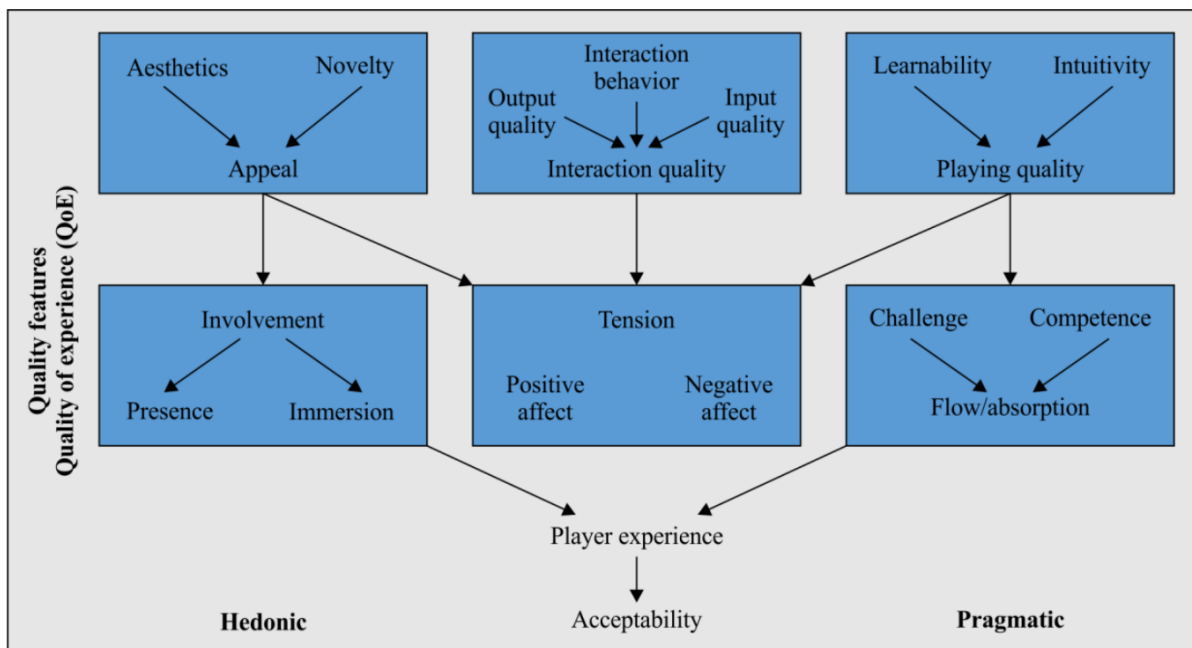

Figure 3.2: Quality features of gaming QoE taken from [111]

With regards to the participants, the recommendation states that even though generally a diverse group of players is desirable to have comparable results, it may be more useful to test persons that represent a service’s target group. As previously stated, player experience is difficult to assess, and in most of the user studies the participants performed self assessment of their gaming experience via questionnaires. Another important part of the experimental set up is a selection of tested games. The major issue concerning the game selection is that there is no existing categorization for online games based on objective game characteristics that could be used to categorize games and allow researchers to perform repeatable experiments (regarding

similarity of the game content), and confirm reliability of their findings. Therefore, there is a need to design an appropriate game categorization for online gaming that can overcome the aforementioned issue, which is also acknowledged in ITU-T Recommendation P.809.

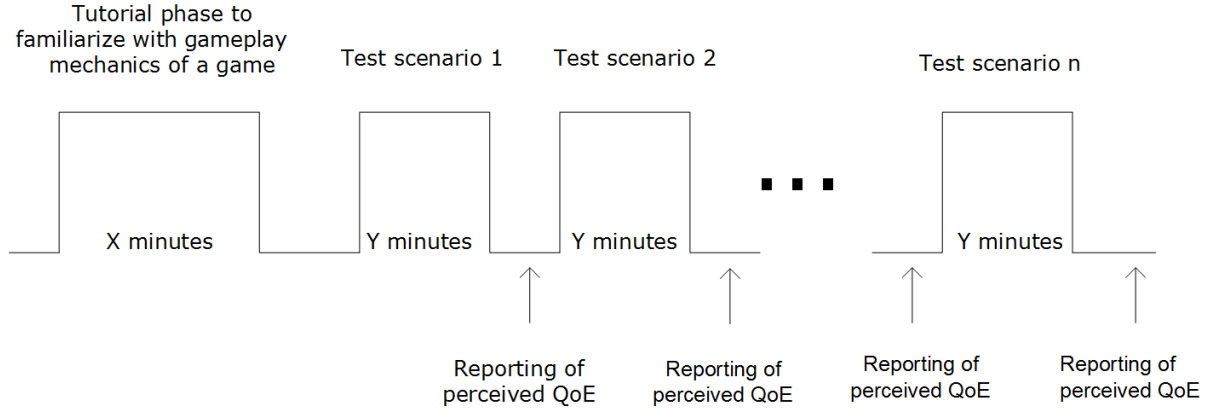

Figure 3.3: An example of evaluation procedure for online gaming

In the scope of this thesis, we investigate the output quality (graphics quality, fluidity), as one of the aspects of the interaction quality. Participants rated perceived graphics quality and fluidity of gameplay using a 5-pt. ACR scale. The test procedure during experiments was similar to the one depicted in Figure 3.3. Additionally, in all our QoE studies we considered games from different game genres.

Recommendation ITU-T G.1072: “Opinion model predicting gaming quality of experience for cloud gaming services”

Finally, Recommendation ITU-T G.1072 [112], published in 2020, presents an opinion model that predicts gaming quality QoE for cloud gaming services. The model was developed based on the work reported in Recommendations ITU-T G.1032 and ITU-T P.809, and it uses an impairment factor approach to estimate MOS on a 5-point ACR scale based on the impact of network parameters (delay, packet loss) and video encoding parameters (video resolution, bitrate, and frame rate) on video and input quality. The model structure is illustrated in Figure 3.4, and is defined as:

$$R_{QoE} = R_{max} - a * I_{VQ_{cod}} - b * I_{VQ_{trans}} - c * I_{TVQ} - d * I_{IPQ_{frames}} - e * I_{IPQ_{delay}} \quad (3.1)$$

$$MOS_{QoE} = MOS_{from_R}(R_{QoE}) \quad (3.2)$$

where

R_{QoE} is the overall estimated QoE expressed on the R-scale, where 0 is the worst quality and 100 the best quality,

R_{max} is the reference value indicating the best possible gaming QoE (= 100) on the R-scale,

$I_V Q_{cod}$ is the estimated spatial video quality impairment for video compression artefacts on the R-scale,

$I_V Q_{trans}$ is the estimated spatial video quality impairment for video transmission errors on the R-scale,

I_{TVQ} is the estimated temporal video quality impairment for frame rate reductions on the R-scale,

$I_{IPQ_{frames}}$ is the estimated input quality impairment for frame rate reductions on the R-scale,

$I_{IPQ_{delay}}$ is the estimated input quality impairment for network delay degradations on the R-scale, and

the constant coefficients a , b , c , d , and e are weighting factors of the model that depend on the game type.

The estimation model can be utilized by the service or network provider to allocate resources to a gaming stream fitting to the existing impairments in the network.

We note the following differences and similarities between QoE models derived based on the collected data in conducted QoE studies and proposed model in this recommendation:

- we modeled QoE only as a function of video bitrate and frame rate, to focus on the cloud game provider perspective,
- our tested games were played and streamed at 720p, while the model in Recommendation ITU-T G.1072 is based on 1080p resolution,
- the lower end of the bitrate spectrum was investigated, inline with the selected lower video resolution and its bandwidth requirements,
- a sequence duration used in our studies in which participants evaluated gameplay quality was double the size of the sequence duration used in Recommendation ITU-T G.1072,
- both models are based on the H.264 video codec.

3.3 Overview of studies addressing cloud gaming QoE

Over the past years there have been significant research efforts in the domain of cloud gaming aimed at studying the relationships between end-user QoE and various network, service, and context factors. While many earlier studies focused on traditional online gaming have provided insight into user-level requirements in terms of factors such as perceived end-to-end latency [33], cloud gaming traffic is inherently different and thus calls for new studies to determine how certain network (e.g., latency, loss) or application-level (e.g., video encoding, content) factors map to user perceived quality metrics.

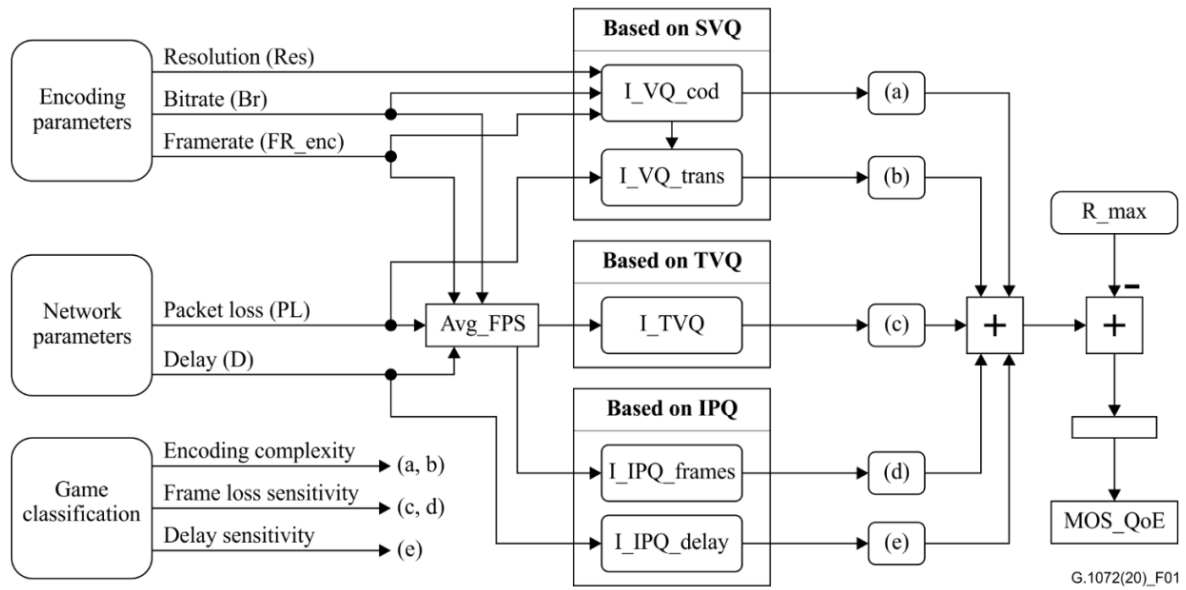

Figure 3.4: The model structure taken from [112]

In Table 3.1 we give a detailed overview of subjective studies that have focused on measuring and modeling QoE for cloud gaming (including the studies presented later in the thesis). The table contains, for each work, the information about the platform on which the tests have been conducted, influence factors which have been tested (e.g., latency, frame rate), tested games, number of test participants taking part in the study, the measurement methodology, and identified results relevant for QoE modeling.

Table 3.1: Overview of studies addressing cloud gaming QoE

Author (Year)	Platform	Tested QoE influence factors			Game genres	No. of participants; environment	QoE measurement methodology	Relevance for QoE modeling
		Network factors	Video factors	Context factors				
Zadtootaghaj <i>et al.</i> (2020) [113]	-	-	Frame rate, bitrate, video resolution	Game genre	Unknown	100; controlled lab environment	continuous scale; video quality, acceptance rating	Proposed models for planning and monitoring purpose based on perceptual video dimensions
Sabet <i>et al.</i> (2020) [114]	Steam Remote Play	Latency	-	Game genre, gaming strategy, user input	FPS, racing, platform	15; controlled lab environment	5-pt. ACR scale; Overall QoE, acceptance rating, input quality	No significant impact of the chosen gaming strategy on the perceived QoE
Slivar <i>et al.</i> (2018) [35]	Steam In-Home Streaming	-	Frame rate, bitrate	Game genre, player skill, group composition	FPS, card game, role-playing game	52 (first study), 28 (second study); controlled lab environment	5-pt. ACR scale; Overall QoE and its features, willingness to play	The same codec configuration strategy may be applied to games belonging to different genres
Zadtootaghaj <i>et al.</i> (2018) [115]	Steam In-Home Streaming	-	Frame rate, bitrate	Game genre	Action, racing	21; controlled lab environment	GEQ	Proposed a model to predict the overall quality based on bit rate and frame rate for tested games
Slivar <i>et al.</i> (2016) [15]	Steam In-Home Streaming	-	Frame rate, bitrate	Game genre, player skill, group composition	FPS, card game	52; controlled lab environment	5-pt. ACR scale; Overall QoE and its features, willingness to play	Modeled QoE as a quadratic function of video frame rate and bitrate
Hong <i>et al.</i> (2015) [13]	GA	-	Frame rate, bitrate	Game genre	FPS, action, racing	101; crowdsourced study	7-pt. ACR scale	Proposed gaming QoE MOS model as a quadratic function of video encoding parameters
Slivar <i>et al.</i> (2015) [14]	Steam In-Home Streaming	-	Frame rate, bitrate	Game genre, player skill	RPG, FPS	15; controlled lab environment	5-pt. ACR scale; Overall QoE and its features, willingness to play	Modeled QoE as a linear function of video frame rate and bitrate
Beyer <i>et al.</i> (2015) [107]	GA	-	Bitrate	-	FPS	32; controlled lab environment	GEQ, EEG	Low video quality imposed by low video bitrate has significant effect on participant's satisfaction
Claypool <i>et al.</i> (2014) [26]	OnLive & GA	Latency	-	Game genre, different type of client's device	Racing, platform	49 (OnLive), 34 (GA); controlled lab environment	7-pt. ACR scale (OnLive); 5-pt. ACR scale (GA); Game play experience	Cloud-based games are as sensitive to latency as FPS games in traditional online gaming

Author (Year)	Platform	Tested QoE influence factors			Game genres	No. of participants; environment	QoE measurement methodology	Relevance for QoE modeling
		Network factors	Video factors	Context factors				
Slivar <i>et al.</i> (2014) [25]	GA	Latency, packet loss	-	Player skill	MMORPG	35; controlled lab environment	5-pt. ACR scale; Overall OoE and its degradations, willingness to play	Modeled QoE as a linear function of network delay and packet loss
Wen <i>et al.</i> (2014) [27]	Ubitus	Latency, bandwidth	-	Game genre, PC set-up, game special effects	FPS, action and fighting	14; controlled lab environment	5-pt. ACR scale; Video and game play smoothness, graphics quality	MOS of all measured QoE components strongly correlated with network delay
Liu <i>et al.</i> (2014) [28]	Exper. set-up	Latency, packet loss	Frame rate, bitrate	Game genre, game content (view distance, texture detail)	FPS, RPG	18 (first study), 23 (second study); controlled lab environment	5-pt. ACR scale; CMR-MOS	Proposed a content-aware model for mobile cloud gaming
Ahmadi <i>et al.</i> (2014) [116]	-	-	-	Game genre, game content	8 different genres	20; controlled lab environment	5-pt. ACR scale	Proposed a game attention model for efficient bitrate allocation in cloud gaming
Jarschel <i>et al.</i> (2013) [45]	Exper. set-up	Latency, packet loss	-	Game genre	RPG, sports, racing	58; controlled lab environment	5-pt. ACR scale; Overall QoE, willingness to pay	Identified key influence factors for cloud gaming QoE
Quax <i>et al.</i> (2013) [24]	OnLive	Latency	-	Game genre	RTS, platform, racing, action	8; controlled lab environment	7-pt. Likert scale & GSR; Perceived game play experience, enjoyment and frustration	Latency has similar impact on QoE for the different genres in cloud gaming as in traditional online gaming
Clinicy <i>et al.</i> (2013) [23]	OnLive	Latency, packet loss	-	-	FPS	50; controlled lab environment	5-pt. ACR scale; 8 categories of QoE used to derive QoE index;	In cloud gaming, FPS players are more sensitive to network impairments than RPG players
Möller <i>et al.</i> (2013) [95]	Exper. set-up	Latency, packet loss, BW	-	Game genre, player skill	Action, casual	19; controlled lab environment	7-pt. ACR scale; 7 quality aspects of QoE	Complexity of activity in game scene should be considered as influencing factor on QoE
Lee <i>et al.</i> (2012) [117]	OnLive	Latency	-	Game genre	FPS, RPG, action	15; controlled lab environment	fEMG	Proposed a game real time-strictness model based on user input rate and game dynamics
Wang <i>et al.</i> (2009) [18]	Exper. set-up	Latency, packet loss	Frame rate, video resolution	Game genre	Sports, MMORPG, racing	21 & 15; controlled lab environment	GMOS (Game Mean Opinion score)	Proposed a model for mobile cloud gaming user experience based on manipulated factors in the study

In terms of test platform used, numerous studies have been conducted using the GamingAnywhere platform, an open source cloud gaming system that allows researchers to perform repeatable experiments and confirm reliability of their study findings [13, 25, 26, 107]. Other platforms used have included Steam In-Home Streaming [14, 15, 35, 113, 114, 115], OnLive [23, 24, 26, 117], Ubitus [27], or other experimentally set-up platforms.

With respect to tested QoE influence factors, a large number of studies have focused on the impacts of latency and/or packet loss on user perceived quality [18, 23, 24, 25, 26, 27, 28, 45, 95, 114, 117], while fewer studies have addressed the impact of different video encoding configurations on QoE [13, 14, 15, 18, 28, 35, 107, 113, 115]. Both studies [18, 28] proposed QoE models for mobile cloud gaming based on manipulated factors in the study. Studies [13, 14, 15] showed that for high bit rates, higher frame rates lead to better overall scores, while for lower bitrates, higher frame rates lead to overall lower scores (attributed to degraded graphics quality in the case of there being more video frames to encode). In this thesis we report on four empirical studies examining the impact of frame rate and bitrate under bandwidth constraints on the end user QoE. In the aforementioned previous studies [13, 18, 28], the lower end of the fps spectrum was investigated, so relatively higher values of frame rate were selected for the studies presented in the thesis (except for Study S3). Further, while a number of previous studies have been conducted using the open source GamingAnywhere platform [13, 107] or experimentally set-up platforms [18, 28], we opt to use Steam in order to conduct tests using both commercial software, and also to enable comparison of different cloud gaming platforms.

While cloud gaming QoE has been previously modeled as a function of network performance parameters [18, 19, 25, 26], in this thesis we focus both on modeling QoE as a function of perceived features (in the scope of Study S3), and also as a function of video bitrate and frame rate (Studies S3-S6). Quality features have been addressed by Hong *et al.* [13], whereby the authors present overall QoE scores as weighted linear combinations of perceived graphics quality and perceived interactivity scores, showing very little variation in weight coefficients across three different game types.

3.3.1 Game categorization for cloud gaming

With regards to tested games, most of the studies have recognized game genre as the context factor having the most significant impact on QoE. As a result, many user studies have considered games from different game genres for conducting QoE tests [13, 14, 15, 18, 26, 27, 28, 35, 45, 95, 113, 114, 115], such as those differing in: camera perspective, graphics style and quality, game play pace, and the intensity of user interaction. As might be seen, a large number of different games have been included in the studies, wherein the differences between some of them can not be clearly identified. Commonly utilized video game genres are primarily derived based on the viewpoint used in the game and the game theme [3]. Based on the viewpoint, games are

commonly categorized as first-person, third-person, and omnipresent, with each of these categories having different QoE requirements for traditional online gaming [16], as well for cloud gaming [24, 45]. In addition to these categories, there are significantly more game categories derived based on game theme, such as action, sports, fighting, racing, shooting, role-playing, and strategy games. A combination of the game viewpoint and the game theme results with numerous distinctive game genres, e.g., first person shooter, third-person action games, and real time strategy. For most such obtained game genres, QoE requirements for game streaming differ [13, 14, 15, 35, 113, 115], although there is an indication that for some game genres, the same adaptation policy could be utilized, as shown later in the thesis. At the beginning of the conducted research presented in the thesis, there was no systematic approach available in literature for selecting which games (or which types of games) to use when conducting QoE studies, as an appropriate game categorization (grouping together games with similar QoE requirements) at the moment did not exist. However, recent activities of Study Group 12 of ITU-T are focused on the development of a method for accurately classifying games into classes, and an example of the potential categorization is given in [17], the follow up work of the results presented in this thesis and the work done in [26].

3.3.2 QoE-aware resource allocation for cloud gaming

The general problem of achieving QoE-driven cloud gaming adaptation has been recently addressed in a number of studies [13, 118, 119, 120, 121, 122, 123, 124, 125, 126, 127, 128, 129, 130]. Tian *et al.* [120] formulate and solve a constrained stochastic optimization problem to minimize overall cost for cloud gaming providers, while adjusting data center selection, virtual machine (VM) allocation, and video bitrate configuration for each user. Achieving cost-effective placement of VMs running cloud gaming servers while maintaining sufficient QoE is further addressed by Hong *et al.* [119]. In recent work, Basiri *et al.* [121] present a resource allocation framework for cloud centers, focusing specifically on accurate delay modeling as the main control parameter for QoE. Amiri *et al.* [122] consider network conditions and game characteristics while assigning appropriate communication paths to gaming flows using SDN (Software Defined Networking). A similar approach is used by Parastar *et al.* [128], with the distinction being that the game rendering was performed at edge servers, while the cloud server processed the game logic, user interactions, and resource allocation. Cloud gaming server selection based on GPU utilization is investigated by Dinaki *et al.* [124]. They compare performance of two proposed evolutionary algorithms for assigning a server to the player, while maximizing both the player's QoE and the GPU utilization. Furthermore, Yami *et al.* [129] consider a game state as one of the factors that impact resource distribution for cloud gaming, as they propose a resource allocation algorithm that assigns a path to each game stream, according to game state, game requirements, and network conditions.

In addition to consideration of issues such as optimized CPU/GPU allocation and VM placement, an important consideration is optimized codec configuration subject to bandwidth constraints. For example, Hegazy *et al.* [127] propose the CAVE method that allocates different amounts of bits to various blocks in each video frame, based on the importance of these blocks to players in order to achieve bitrate savings. In this thesis, we focus on this issue and investigate how optimized video configuration across multiple game flows sharing a common network bottleneck (e.g., sharing the outgoing link of a data center) can maximize QoE and fairness among involved players.

3.4 Chapter summary

In this chapter we first discuss definitions related to QoS and QoE, and briefly summarize typical QoE assessment methods. We further give an overview of gaming QoE aspects and assessment methods for online gaming. Finally, an overview of studies addressing assessing and modeling QoE for cloud gaming is given. Based on the thorough state-of-the-art analysis of conducted research on cloud gaming QoE, we identified key issues that were described in Chapter 1, and addressed in the following chapters.

Chapter 4

Impact of network factors and game type on QoE

While cloud gaming reduces client hardware requirements and provides other benefits, game streaming is traffic intensive and may significantly increase the network requirements necessary to secure a good level of QoE. To meet user expectations and improve their overall satisfaction with a service, the first step is to identify key influence factors on QoE for the corresponding service. Due to the nature of cloud gaming (networked multimedia service), we first investigated the impact of varying network conditions on QoE in two user studies presented in this chapter. Study S1 assessed whether (and to what extent) the rendering and streaming of game content to client devices imposes a degradation in gaming QoE as compared to the case of playing using a traditional online game client (results published in [25], and described in Section 4.1), while Study S2 analyzed the commercial NVIDIA GeForce NOW game streaming platform in terms of its adaptation mechanisms in light of variable network conditions (results published in [29], and described in Section 4.2). The results from both studies provided insights into limitations of currently deployed adaptation mechanisms for cloud gaming platforms available at the time, and provided input for designing our subsequent studies aimed at deriving video encoding adaptation strategies.

4.1 Study S1 - Degradation in gaming QoE imposed by switching to cloud gaming

Study S1 aimed to answer the following question: *“How does using a cloud gaming platform affect the gaming QoE when compared to a ‘traditional’ game client?”*. To answer this question, a user study with 35 users was performed to analyze an in-home streaming scenario involving multiplayer online gameplay. The in-home game streaming scenario was set up using the GamingAnywhere platform [41], and participants were asked to provide subjective QoE as-

assessment while playing the Massive Multiplayer Online Role Playing game (MMORPG) World of Warcraft. The impact of different network delay and loss conditions on players' QoE was investigated, with the network impairments emulated along the external Internet link from the online game server to the "home" set-up.

4.1.1 Methodology

The subjective study was conducted in two phases: the first consisted of participants filling out a pre-survey by way of an online questionnaire, and the second consisted of participants taking part in a two and a half hour long gaming session in a laboratory environment. A total of 35 participants, all masters level students enrolled at the University of Zagreb, Faculty of Electrical Engineering and Computing, were engaged in both of these phases.

Pre-survey

Prior the study, participants were asked to fill out an online questionnaire and report their previous gaming experience (with emphasis on multiplayer games and MMORPGs) several weeks before the laboratory testing. 22% reported having previous experience playing MMORPGs and only 2 of 35 participants reported having any kind of experience with cloud gaming. Participants were also asked to rate their perceived skill at gaming as "novice", "intermediate" or "skilled" gamer. 31.4% of the participants declared themselves as novice gamers, 51.4% considered themselves to be intermediate gamers, and 17.2% considered themselves as skilled gamers. Along with game experience, the following data was collected about participants: participant's demographics, their computer hardware and Internet connection type used while playing online games, motivation for playing games, and their opinion with regards to acceptable delays for different types of games. As an example, survey results showed that participants consider an average of 168 ms to be an acceptable RTT threshold for MMORPGs, and an average of 122 ms RTT to be acceptable for FPS games. The results of the pre-survey, in particular as related to previous player experience, were subsequently used in forming participant test groups (as described later in the section).

Laboratory set-up

The laboratory set-up is shown in Figure 4.1. The game used for testing purposes was World of Warcraft. The WoW client was installed on PC 1 - PC 5, five Windows 7 desktops, each with Intel 3.3 GHz i3 processor, 4GB RAM and GIGABYTE Radeon R7 250. With the aforementioned PC configurations and WoW client's graphic settings set to *high*, WoW's frame rate was around 60 fps. To emulate a cloud gaming environment, the GamingAnywhere platform was used (version 0.7.5). The GA server was installed along the WoW client on PC 1 - PC

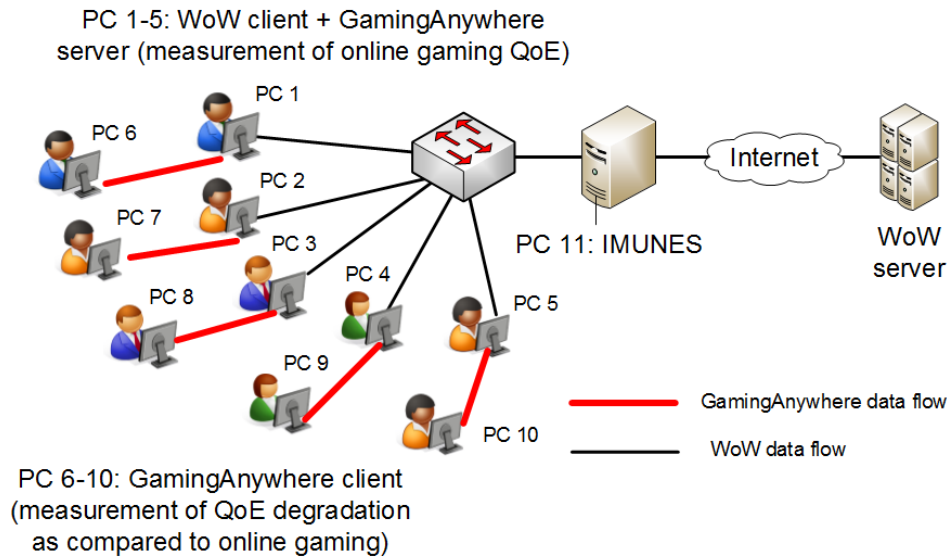

Figure 4.1: Laboratory testbed in Study S1

5, with default H.264 video encoding and decoding settings, and with video bitrate set to 3 Mbps. Such low bitrate for video encoding was imposed by limited hardware capabilities of PCs used in the study, which could not run the game and encode the video stream at high bitrates, resulting in lower video frame rate and frame rate drops. Therefore, this experimental design represents lower-end conditions under which end-users would use in-home game streaming. The GA server was running in periodic (desktop capturing) mode, implying that the entire desktop was streaming to the GA client, because of technical problems with streaming of WoW in event-driven mode. GA clients were installed on PC 6 - PC 10 with Windows 7 OS, Intel 3.3 GHz i3 processor, 4GB RAM, ATI Radeon HD 6450, with default H.264 video decoding settings. The Integrated Multiprotocol Network Emulator/Simulator (IMUNES) [131] was used for manipulating network conditions on the link from the WoW server to PCs 1 - 5.

As previous research has shown [101], two main network parameters affect the QoE of MMORPGs: delay and packet loss. High network delay postpones execution of user inputs on a server and prolongs the delivery responses to the client, whereas high packet loss leads to spikes of network delay due to use of TCP for the particular MMORPG (WoW). Therefore, in this experiment both of these parameters were manipulated. Delay was introduced in the testbed through PC 11 using the previously mentioned IMUNES tool. Three levels of one-way delay were introduced during conducted experiments (75 ms, 150 ms and 225 ms) that increased the average value of RTT by 150 ms, 300 ms, and 450 ms, respectively. These delay times were selected based on the pre-survey results, and previous studies performed on the GA platform [132]. As there was no control over the Internet connection to the testbed, we note that nominal RTT to the WoW server was between 30 and 40 ms. Likewise, three levels of packet loss were introduced on the same PC using a FreeBSD firewall: 3%, 5%, and 7%. These packet loss

percentages were based on a previous study addressing gaming QoE of MMORPGs, which showed that packet loss higher than 10% leads to serious degradation of the gaming experience [101] and data regarding real wireless networks (3G) in which these values can occur [133]. Finally, the context in which the game was played was manipulated in terms of game client, with users switching from playing using a traditional online gaming client and a cloud gaming client.

Test procedure

Overall, 35 participants were included in the study, 21 male and 14 female. The average age of the participants was 23, with ages ranging from 22 to 28. The participants were organized into seven groups (five players in each group), based on their reported gaming skill. Each of the formed groups had at least one novice player and one skilled player. Each group had two female players and three male players.

Due to the fact that network parameters (delay, packet loss) were manipulated at three levels (and one additional condition without degradation), a total of 16 different conditions were tested and evaluated during the study. All conditions were tested by each player group. Each test scenario consisted of two phases, during which time network conditions were kept constant: in the first phase, players were requested to play WoW on standard WoW clients running on PC1-PC5 (without the cloud gaming platform), while in the second phase they switched to a PC running the GA client (PC6-PC10) and continued gameplay. Each phase of a given test scenario lasted 3 minutes. The fact that players knew when they would switch to in-home streaming possibly leads to bias in QoE scores, but without serious modifications of the experimental design, the described transition could not be concealed. The entire testing session lasted for two and half hours, with a 15-minute break allotted in the middle. The overall methodology is shown in Figure 4.2. Even though this was a very long period for players to hold their attention and focus on gameplay quality degradations, the majority of participants were highly immersed in the virtual world and engaged in playing with other players during the course of the experiment (based on user feedback). At the beginning of the session, players first played under the best (no network degradations) followed by the worst (400 ms RTT, 7% packet loss) network conditions, and were told that these were reference conditions. After playing under reference testing conditions, for the remaining test conditions players were not aware of the degradation levels of network parameters. Additionally, the sequence of test scenarios was randomly selected across different player groups to avoid a possible bias of manipulated parameters.

During the course of the experiments, there was always a test administrator present who controlled test conditions and provided players with minimal assistance in case of problems with gameplay (e.g., player getting lost in the virtual environment, player avatar “dying”, etc.). Players were instructed to fill out a questionnaire and provide subjective scores, with respect to

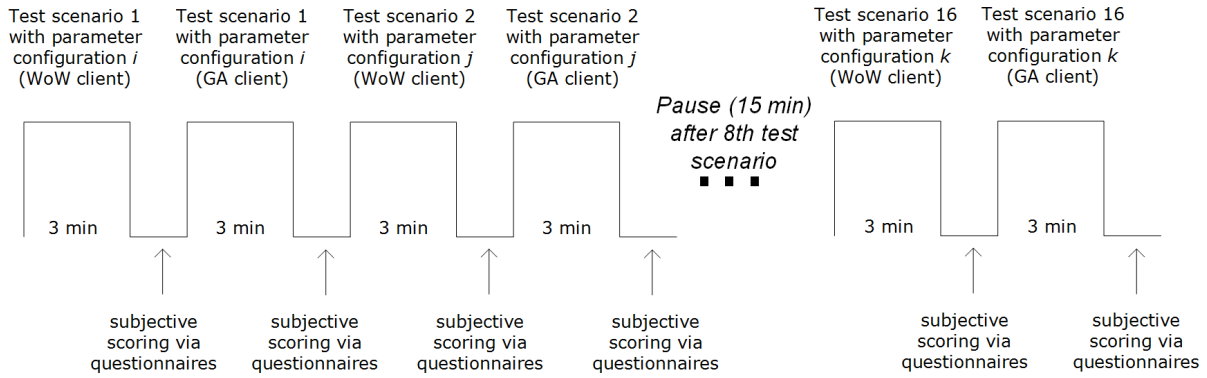

Figure 4.2: Study S1 methodology

Table 4.1: Subjective ratings collected during the test procedure

Subjective ratings	Rating scale
1) Overall QoE	5 pt. MOS scale (1-bad, 5-excellent)
2) Degradation of overall QoE	5 pt. DMOS scale (1-very annoying, 5-imperceptible)
3) Willingness to continue playing	yes/no

criteria given in Table 4.1. For a given test scenario, after the first phase players provided ratings for their overall QoE, and indicated whether or not they would continue to play the game under the current network conditions. In the second phase, players switched to playing (under the same network conditions) on the GA client, and rated the perceived degradation as compared to that in the first phase and whether or not they would continue to play the game under the current test scenario conditions. A standardized 5-point degradation Mean Opinion Score (DMOS) scale [134] was used for rating the degradation of overall QoE. During the experiment each group of five players was involved in joint actions related to WoW dungeons, meaning they interacted as a group and played cooperatively to survive in the virtual world.

4.1.2 Results

Impact of delay and packet loss on QoE for online gaming

The mean values of perceived QoE depending on test scenario conditions are shown in Figure 4.3. The values for all test scenarios, even for the worst scenarios, were relatively high (around 4, which can be considered “good”). In a similar study, in which the influence of various system, user, and context parameters of QoE on MMORPGs [101] was investigated, it was found that players’ QoE was very mildly influenced by added network delay up to 400 ms which was

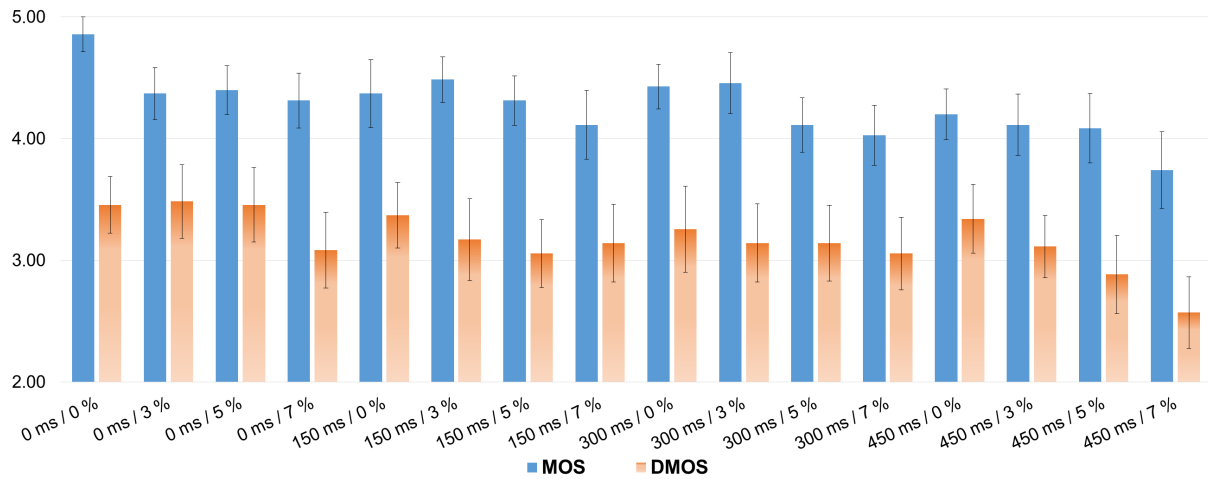

Figure 4.3: Subjective ratings of overall QoE during online gaming and degradations of overall QoE during cloud gaming

in contrast with findings reported in study [102]. The hypothesis presented in study [101] to explain this phenomena was that delay degradations were “masked” in players’ perception by other more severe degradations (e.g., jerkiness and frame rate). This study had a very similar laboratory experiment, but without degradation of jerkiness (referring to short bursts of very low frame rate) and frame rate, and delay shows consistent results with study [101] and a very mild impact on QoE (i.e., added network delays of 450 ms RTT did not reduce the reported QoE below 4). On the other hand, this study involved playing on a cloud gaming client which was graded very low by the players and might be the reason what caused the masking effect. The differences between described studies (Study S1 and study [101]) and previous work studying WoW (such as [102]) may also be explained by improvements in the game code under test, or by the fact that a significant number of players participating in the study were inexperienced in playing the specific game.

To quantify the impact of network delay and packet loss, Pearson’s product moment correlation r was computed, which shows a negative correlation between QoE during traditional online gaming and network delay ($r = -0.34$) and packet loss ($r = -0.29$). In addition to Pearson’s product moment correlation, linear regression analysis of delay and packet loss impact on QoE was applied. It should be noted that the data was considered as interval data and not ordinal (i.e., the intervals between points on the rating scales are equal). Also, due to the nature of the dataset, visual inspection of skewness and kurtosis of the data was performed, as well as the Rayan-Joiner normality test was applied (similar to Shapiro-Wilk test). The results showed that some of the test scenario results exhibit a higher level of skewness and kurtosis. It should be noted that while Analysis of Variance (ANOVA) is quite robust on non-normality violations [135] it should be taken into consideration when using the obtained model. ANOVA results show that both delay and loss had significant impact ($p - value < 0.01$), with delay having a stronger impact. The average perceived QoE score in this study can be modeled by the fol-

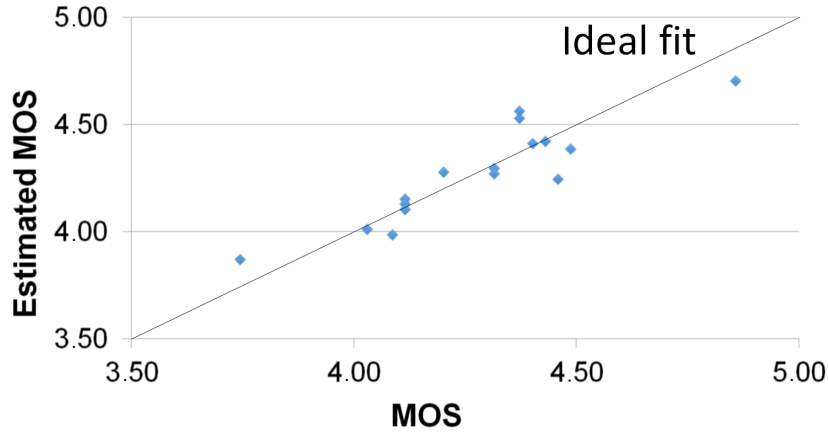

Figure 4.4: Accuracy of predicted MOS ratings vs subjective MOS ratings

lowing multiple linear regression model based on only these two parameters (packet loss and network delay):

$$MOS = 4.7059 - 0.00094 * ND - 5.83444 * PL \quad (4.1)$$

where ND represents network delay in milliseconds and PL packet loss. The accuracy of the derived prediction model is shown in Figure 4.4. By observing network performance for individual users and predicting their gaming QoE, it could be possible to efficiently manage network resources, optimize game data delivery to end users and, ultimately, increase perceptible QoE affected by network state.

QoE degradation imposed by switching to in-home game streaming

In Figure 4.3 average degradation ratings of QoE are shown in comparison with traditional on-line gaming while the participants were playing on the GA client for all degradation scenarios. It should be noted that two different measures are shown (MOS for phase one of the test scenario and DMOS caused by switching to GA for phase 2). Such high DMOS values reported by the study participants, indicating severe degradations, may be attributed to default settings of GA (i.e., bitrate of only 3 Mbps).

Once again linear regression analysis on network parameters was applied to test the impact on degradation of QoE in cloud gaming. This time analysis showed that packet loss had slightly more significant impact on degradation of QoE than network delay. The average perceived QoE score was modeled by the following multiple linear regression model (4.2):

$$DMOS = 3.5578 - 0.00081 * ND - 5.4473 * PL. \quad (4.2)$$

The accuracy of the chosen prediction model is shown in Figure 4.5.

Taking into consideration other degradations of QoE that the participants evaluated, similar correlations between network parameters and perceived degradations can be found. Only one

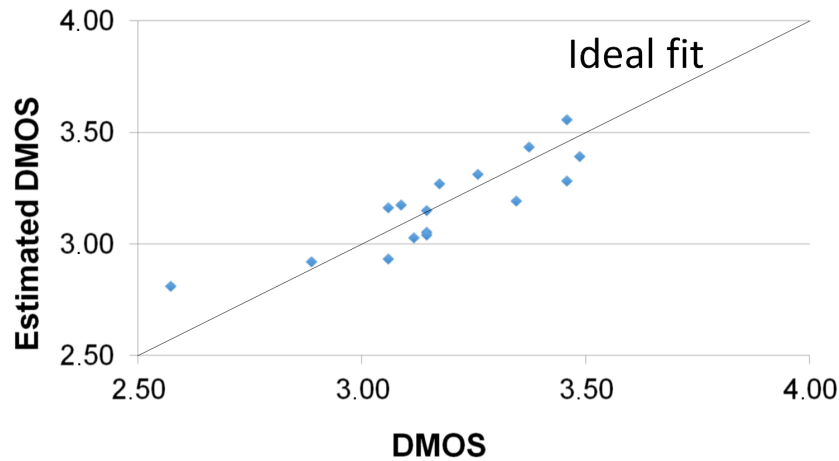

Figure 4.5: Accuracy of predicted DMOS ratings vs subjective DMOS ratings

aspect of QoE was not as highly impacted by network delay and packet loss as others, and that is graphic representation of gaming content. This can be attributed to fact that packet loss was not introduced on the cloud gaming link and therefore the WoW client compensated high latency and high packet loss with in-game mechanics such as Dead Reckoning. To face this issue, traffic and system parameters on the cloud gaming link could be manipulated in similar future experiments.

Relationship between DMOS and MOS

The average QoE degradation levels depending on the overall QoE ratings across all scenarios are shown in Figure 4.6. In other words, the graph explains how players rate the degradation introduced by switching to GA depending on how they scored the first phase of the same scenario. There is a linear relationship between degradation ratings and overall perceived QoE ratings. This means that the greater the present degradation (i.e., greater latency and loss) in the first test phase of the scenario (inline gaming client), the switch to cloud gaming seems more severe to the player. This relationship is in line with the generic IQX hypothesis postulated in [136], showing an exponential relationship between QoS and QoE, and stating that the change in QoE with respect to QoS degradation depends on the current QoE level. For example, if the current QoE level is very high, the addition of a fixed amount of service degradation will cause smaller perceived degradation compared to when the service is already degraded and the same fixed amount of service degradation is added.

This findings are illustrated in the context of the IQX hypothesis in Figure 4.7, showing a generic relationship between QoE and introduced degradations. It should be noted that in addition to network-related degradations due to delay and loss, a constant degradation (shown in the figure as X_c) is imposed due to the fact that a game is played on the GA client. In line with the IQX hypothesis, three areas of degradation are presented: (1) no distortion perceived,

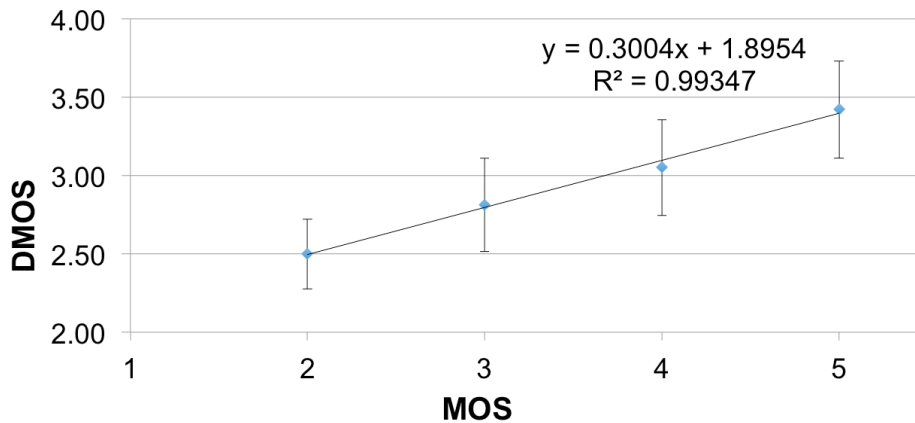

Figure 4.6: QoE degradation ratings depending on QoE ratings

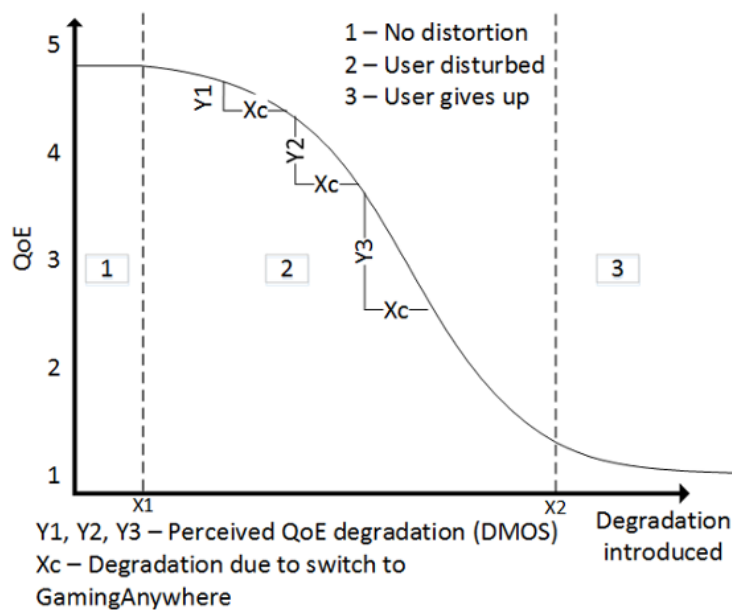

Figure 4.7: Impact of additional constant degradation on perceived QoE

(2) user disturbed, and (3) user gives up. Within most test scenarios, players were located in the “user disturbed” area. It has been shown that that latency up to 150 ms is tolerated by players of MMORPGs [102]) (shown as x_{1c} in Figure 4.7), while the values of DMOS presented in the figure actually present the slope of the degradation curve.

Impact of delay and packet loss on willingness to play

One of the most important evaluation ratings of an online interactive application is the end user’s willingness to continue using it under degraded performance caused by system or network impairments. *Willingness to play* results shown in Figure 4.8 show that the participants have much higher willingness to keep playing under degraded conditions while playing on a WoW client than playing on the GA client, regardless of their gaming skill. This can be attributed to the experiment’s design and the participants awareness of switching to poorer gameplay conditions:

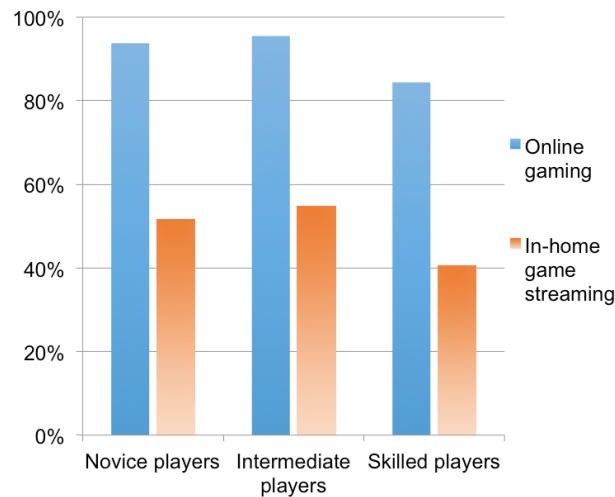

Figure 4.8: Willingness to play based on user gaming skill

after playing in the “best possible” settings on WoW client for a given test scenario, they had to physically move to other PCs and continue playing with degraded game quality (mainly graphic quality). Future studies with similar experiment design probably should conceal the fact that the switch to the in-home game streaming is about to happen, or reverse the order of phases in the experiment to avoid this phenomenon. When considering the influence of player gaming skill, it can be observed that skilled players in greater percentage would stop playing after switching to in-home game streaming in comparison with less experienced players. Skilled player are more aware of degraded game performance and even minor system/network degradations have a high impact on their eagerness to keep playing. This confirms the findings of previous research [101] that experienced players are more demanding of game quality.

Summary of key findings: While this study was published during the early phase of our research in 2014, it provided important insights with respect to the impact of network parameters on cloud gaming QoE. Results showed that the perceived degradation from switching to cloud gaming client changes and depends on existing degradation of quality under occurring network conditions. Additionally, positive participant’s feedback during experiments showed that widespread use of in-home game streaming is possible if adequate video quality is guaranteed during streaming. Since that time, cloud gaming platforms have advanced, with streaming bitrates reaching 10 Mbps for 720p, and 25 Mbps for 1080p. Therefore, in subsequent QoE studies we focused to investigate a higher spectrum of bitrates for 720p, and test the impact of video encoding parameters on user’s QoE.

4.2 Study S2 - Service adaptation mechanisms in light of variable network conditions

Study S2 aimed to analyze and evaluate the service adaptation mechanism implemented in the commercial product NVIDIA GeForce NOW. The study, conducted in 2016, reported on a combination of both objective observations regarding adaptation behavior (as observed at the time the study was conducted), as well as subjective user ratings under different network conditions.

4.2.1 Analysis of GeForce NOW service adaptation behavior

The network connection settings which could be manipulated included the characteristics of the incoming video and the target network bandwidth consumption. The characteristics of the incoming video were tuned to four predefined levels involving the following combinations of resolution and frame rate: 1080p@60FPS, 720@60FPS, 1080@30FPS, and 720@30FPS. Additionally, there was an *auto* option which allowed the GFN service to determine the best combination of frame rate and resolution to set according to the estimated bandwidth availability. If the *auto* option was not chosen, the user could manually decide whether or not to allow the service to dynamically adapt to network conditions. If the option was not enabled, the incoming stream was set at a fixed combination of resolution and frame rate even if bandwidth availability was severely reduced. The Shield console offered the option of outputting a 4K resolution video to the TV to which it is connected, but at the time of the study this option was only reserved for NVIDIA GeForce Experience (i.e., streaming games from a local PC), but not for GFN. The network bandwidth consumption could also be set using the *auto* option or could be manually set to any value between 4 Mbits/s to 30 Mbit/s. Although the suggested values of bandwidth consumption on the GFN web page were listed as 10, 20, and 30 Mbit/s, the game stream could be delivered even at 4 Mbit/s, although with significantly reduced video stream quality (usually with 540p@30FPS).

Laboratory testbed

The laboratory testbed used to conduct the study is shown in Figure 4.9. Players used a wireless gamepad for controlling the game. Optionally, a keyboard and mouse could be connected to the Shield console via USB ports. The shield console was connected via an HDMI cable to the television set on which the game content was displayed. Shield was connected to the Internet and GFN servers via Albedo's Net.Storm¹ and Net.Shark² devices. Net.Storm is a commer-

¹http://www.network-testers.com/albedo_net_storm.html

²<http://www.albedotelecom.com/pages/fieldtools/src/netshark.php>

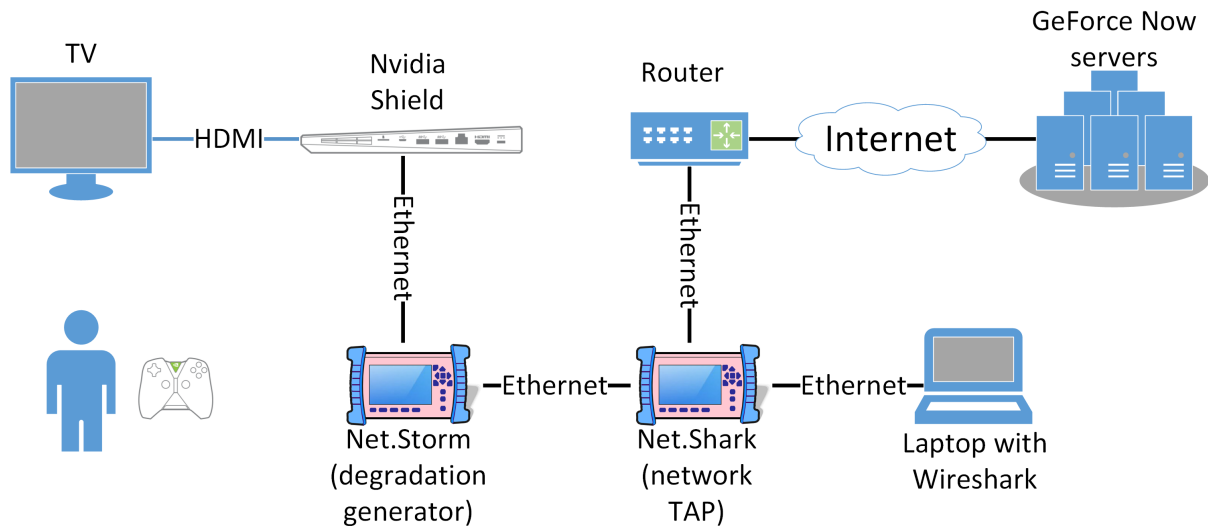

Figure 4.9: Laboratory testbed for testing GeForce NOW service adaptation behavior

Table 4.2: Measured parameters of our network compared to required and recommended parameters for GFN

	Estimated	Required	Recommended
Bandwidth	> 50 Mbit/s	> 20 Mbit/s	> 50 Mbit/s
Frame loss	< 0%	< 3%	< 1%
Jitter	18 ms	< 80 ms	< 40 ms
Latency	22 ms	< 80 ms	< 40 ms

cial grade network emulation device that can apply a wide range of network impairments to IP/Ethernet streams, including bandwidth limitations, latency, and loss via a variety of modes (e.g., bursts of loss or exponentially distributed latency). Net.Shark is a portable network tap which was used to aggregate and replicate the traffic passing between the Shield console and GFN servers. Traffic was then sent to a laptop and captured using Wireshark. In this way the impact of packet capture on the processing power of the end device was eliminated.

Prior to initiating gameplay, the Shield console offered a network test option in which the characteristics of the network are estimated. It should be noted that under unimpaired conditions, the network was graded as “Excellent network”. The values of *evaluated*, *required*, and *recommended* network parameters for GFN are listed in Table 4.2 (parameters are depicted as reported by the Shield console). Video stream parameters were measured through a built-in tool in the Shield console. When activated, data in the following format was dynamically portrayed in the upper right corner of the screen: *<resolution>@<frame rate> <bandwidth used> <percentage of available bandwidth used> <number of lost frames>*.

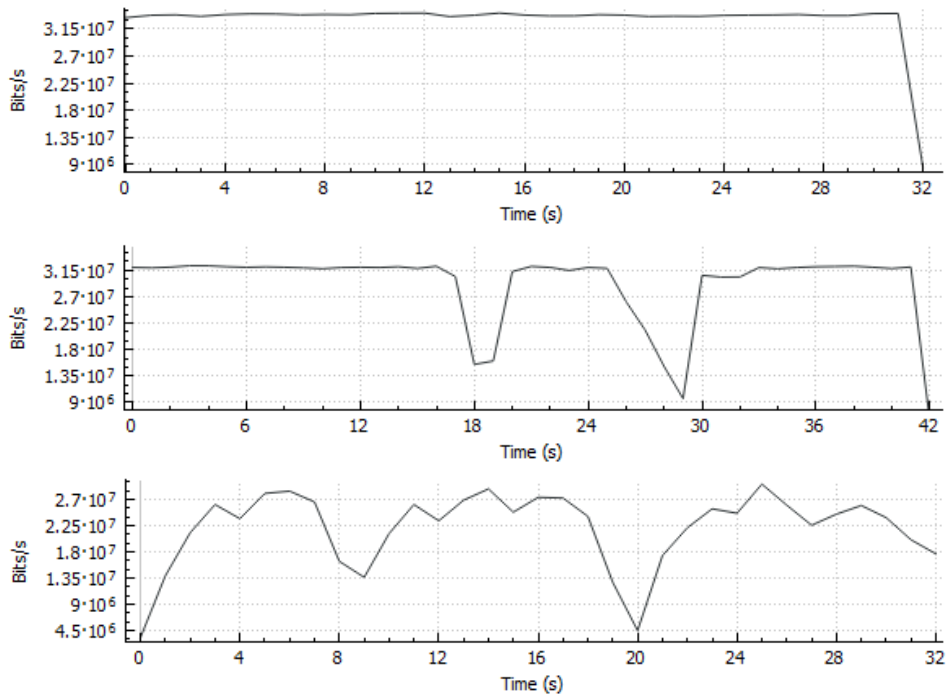

Figure 4.10: Bandwidth usage for (top to bottom) Drift 3, Ultra Street Fighter 4 and Pumped BMX +

Traffic analysis

To obtain insight into the traffic characteristics of the GFN service, GFN traffic for three different game was recorded and analyzed, while the adaptation option was set on *auto* and with no degradations imposed in the network. The following three games were tested: *Dirt 3* as an example of a racing game, *Ultra Street Fighter IV* as a 2D fighting game, and *Pumped BMX +* as an arcade sports platform game. The same games were subsequently used in subjective studies, reported in the following section. The traffic of approximately 30 seconds of gameplay was captured for each game, resulting in approximately 390 MB of traffic. Traffic analysis was done using the tools *OmniPeek* by WildPackets [137], and *Wireshark* [138]. GFN uses RTP over UDP to deliver video content, which in the conducted measurements was always delivered from a single IP address. Figure 4.10 illustrates the bandwidth usage of all three tested games. The bandwidth usage greatly depends on the characteristics of the video being sent. Consequently, the greatest variation may be observed in the case of the BMX game, where gameplay levels are short and there are stationary points in the video when levels are reset, while in *Dirt 3* there is almost no variation as the state of the virtual world is relatively constant, corresponding to car racing. Traffic was very asymmetric, with the majority of packets and data being sent in the downlink direction (95.45%). The majority of downlink packets was fixed at 1080 bytes (B) (over 90%), while the remaining packets were mostly smaller than 126 B. The distribution of packet sizes in the uplink direction had discrete steps with prominent values (102 B, 118 B, 142 B, and 150 B).

Adaptation to network delay, delay variation, packet loss, and bandwidth shaping

In the effort to better understand the adaptation algorithm employed by the GFN service, different amounts of bandwidth limitations, latency, delay variation, and packet loss onto the network link were introduced using the Net.Storm emulation device. All tests were performed multiple times to ensure validity of observed behavior. It should be noted that prior to running all tests, the Shield console network test was run on an unimpaired network to evaluate network conditions. Once the network test is performed, it appears that the service remembers the conditions in which the network test has been last performed. For example, if throughput is limited to 10 Mbit/s prior to running the network test, the service will not try to push more than 10 Mbit/s at any time, even after the bandwidth restriction has been lifted.

Latency

A goal was to test GFN service behavior in light of a small amount of latency dynamically added during gameplay. Surprisingly, when inserting an additional latency of 10 ms or more (tested adding delay of 100, 50, 20, and 15 ms) in the downlink direction *during* gameplay, it was observed that bandwidth consumption quickly drops to approximately 2 Mbit/s, and within seconds the streamed video drops to the lowest possible setting (in this case 30FPS@540p). However, if the latency is introduced before the game itself was started, this degradation does not occur. To clarify, measured base RTT to GFN servers was 22 ms. By adding 10 ms of latency while still on the game selection screen, and then starting the game, the game would stream normally (with the auto setting enabled in the testbed, corresponding to 1080p@60FPS and bandwidth usage around 30 Mbit/s). This unexpected behavior is either a weakness of the system in terms of bandwidth estimation algorithm, or that the specific way in which the Net.Storm emulator adds latency somehow “tricks” the system. To rule out the second case, the same tests were conducted using a different emulator, namely the freely available IMUNES emulator/simulator tool³, and results in terms of GFN service behavior proved to be the same. This leads to two conclusions regarding the GFN adaptation algorithm: the bandwidth estimation and adaptation algorithm is somehow based on RTT, and **bandwidth adaptation is only triggered during gameplay and not in the game selection screen**. When latency added during gameplay was removed, the system recovered to nominal settings (1080p@60FPS with bandwidth usage around 30 Mbit/s) within seconds. If the added latency was not removed, the system again recovered, but much slower and differently depending on characteristics of the video stream.

Two scenarios were tested in Dirt 3: 1) with active gameplay - the player continued to drive the car, and 2) with passive gameplay - the car was stopped and there was no action. The

³<http://imunes.net/>

results are depicted in Figure 4.11 and Figure 4.12. First, it can be concluded in both cases that the adaptation algorithm valued more frame rate than resolution, as reductions were first observed in terms of resolution, followed by frame rate. Moreover, in the recovery phase, the frame rate was increased first, and afterwards the resolution. In the active gameplay mode, it took approximately 2 minutes for the game to recover, and the recovery started only when the GFN service reported that the value of the *percentage of available bandwidth used* reached 0%. There was not an explanation why the recovery starts at 0% of available bandwidth used. On the other hand, in the passive gameplay mode, the resolution and frame rate increased significantly prior to the bandwidth. This can be attributed to the complexity of the video, as the car was stopped and the image was relatively static, enabling the resolution and frame rate to reach peak values even for 2 Mbit/s. Based on this it can be concluded that the adaptation of frame rate and resolution is separate from the bandwidth evaluation algorithm and is likely based on spatial and temporal video complexity and the current bitrate the video coder has available. For passive recovery it can be seen that the system first recovered to around 14 Mbit/s which was sufficient for full quality of the still image, and increased to 30 Mbit/s immediately after gameplay was continued. Also it can be assumed that the GFN bandwidth estimation algorithm runs in very small time periods or possibly even at the level of several or single video frames. Adding 10 ms of latency stopped some of the packets from arriving for that period. In this initial halt of packets, the system recognized that it was not receiving enough data and responded by reducing the amount of data sent. The question remains as to why it takes so long for the system to recover while this added latency is present, while the system responds almost immediately if the added latency is removed.

Delay variation (jitter)

The impact of adding delay variation was tested by inserting latency according to a uniform distribution ranging from 10 ms to 45 ms. It should be noted that delay was inserted per each single packet, and that reordering of packets was allowed. In this way inserted delay of one packet does not influence the subsequent packet. This approach does not significantly change the general statistics of inter-arrival times of subsequent packets on the receiver side (while it does change ordering of packets). The observed results were time of two subsequent packets. The system immediately reduced the amount of data sent to only 2 Mbit/s and dropped the resolution and frame rate to the minimal supported value (540p@30FPS). The difference with respect to inserting deterministic latency was that the system did not recover to the full (peak) quality.

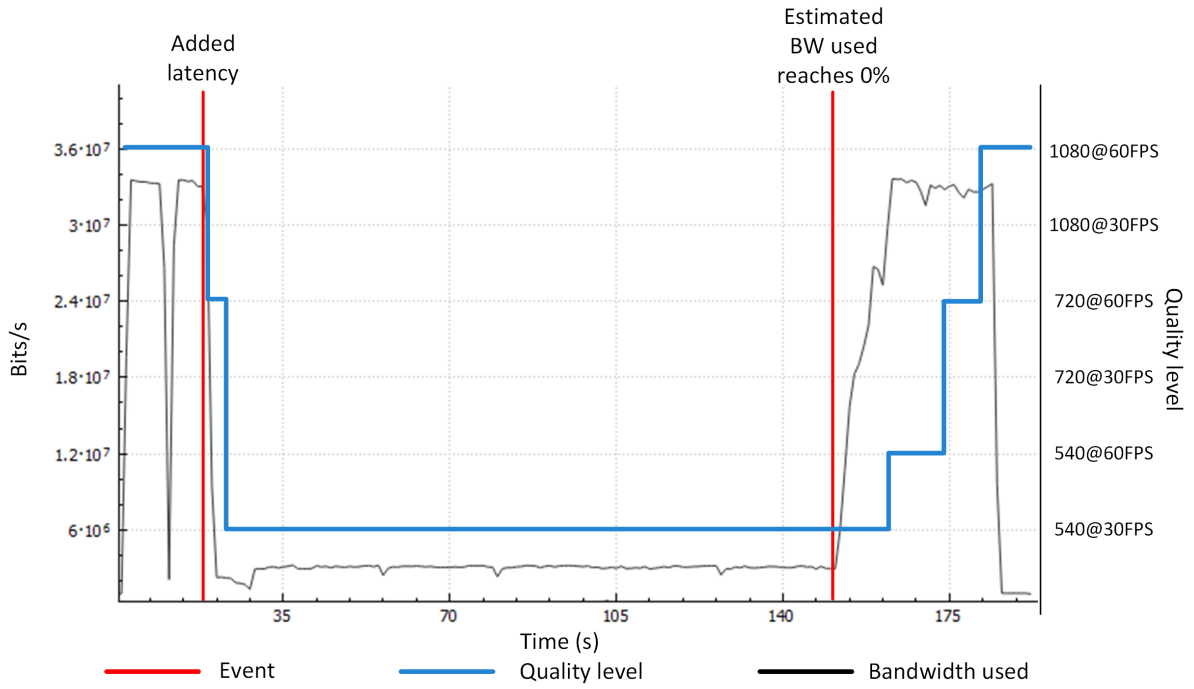

Figure 4.11: Adaptation with active gameplay in Dirt 3

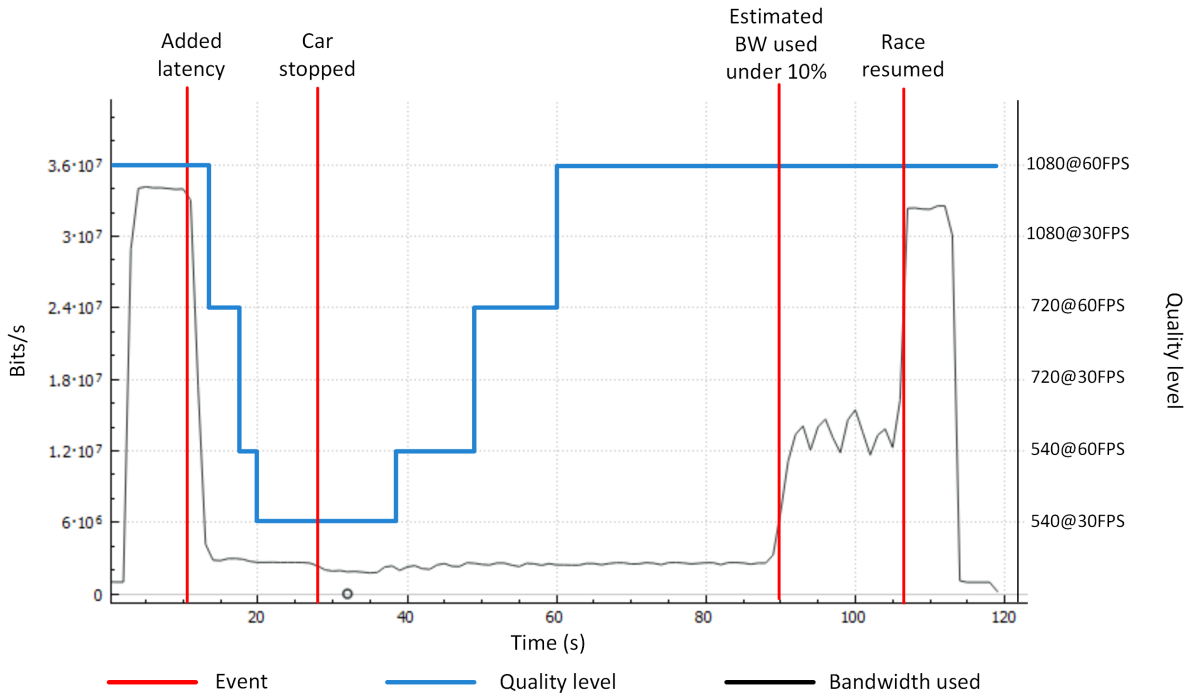

Figure 4.12: Adaptation with passive gameplay in Dirt 3

Packet Loss

Tests showed that the GFN service is very resilient to packet loss, likely due to the use of Forward Error Correction mechanisms. Even at loss rates of 10%, the gameplay was fluid and only minor glitches occurred. On the other hand, there was no reaction of the bandwidth adaptation algorithm, which remained at a constant rate even with losses of 10% in both uplink and downlink directions. This leads us to the conclusion that the bandwidth estimation algorithm is impacted primarily by latency when detecting possible network congestion.

Bandwidth limitation

Limiting the bandwidth was carried out with two techniques available on the Net.Storm device: *policing* and *shaping*. Both techniques are based on a token bucket system where in the case of shaping, packets are put into a queue if tokens are spent, and in case of policing the packets are immediately dropped if there are no tokens in the bucket. Because the system reacts by reducing bandwidth consumption only when latency is added, we chose to limit the bandwidth with the shaping option (in the case of using the policing option, the service degraded severely and eventually disconnected). The system proved quite responsive and limited the bandwidth sending rate within seconds. We observed what combinations of resolution and frame rate occur for different bandwidth limitations and results are depicted in Figure 4.13. For some bandwidth values two different combinations of resolution and frame rate were noticed depending on the characteristics of the video (e.g., in Drift 3 a drop to lower settings would often occur when the car would crash off the road). From Figure 4.13 it is noticeable that for Pumped BMX + much lower bandwidth was required to reach maximal quality level than in the other two games (13 Mbit/s as opposed to 19 Mbit/s), while the other two games quite similarly adapted to bandwidth limitations. These adaptations are based on spatial and temporal video characteristics for each game - Pumped BMX + has significantly lower graphics detail and is less dynamic than other two tested games.

Finally, all tests were conducted using all three tested games, and no significant difference in behavior was detected. These leads to the conclusion that the GFN adaptation algorithms implemented at the time this study was conducted were not dependent on a particular game nor game type being played, but only on video characteristics.

4.2.2 QoE evaluation of the GeForce NOW adaptation strategy

To evaluate the impact of the GFN service adaptation algorithm on player's QoE under various network conditions, a user study was conducted consisting of players taking part in approximately 45 minute long gaming sessions that were run in the previously described lab testbed (the network TAP device was removed to eliminate the possibility of additional delay induced

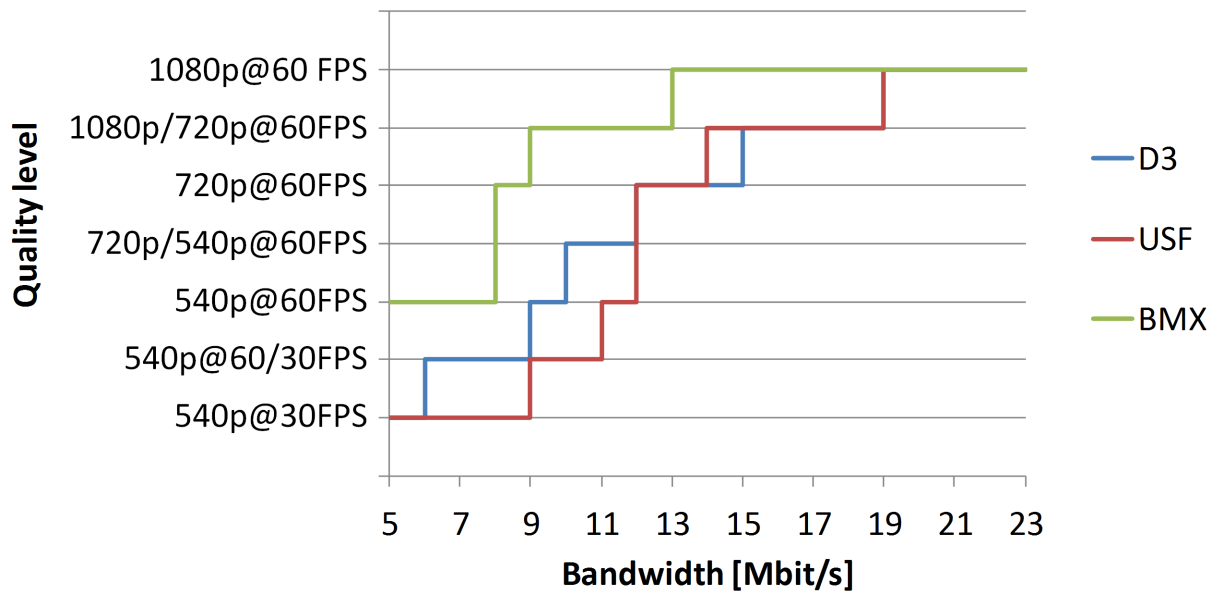

Figure 4.13: Quality levels of tested games on various bandwidths

by this device). The three previously mentioned games were used for testing. Although all three games belong to different game genres, they all fall under the category of more dynamic games in terms of gameplay pace, but due to a limited selection of slow-paced games with a short learning curve provided by the GFN service, these games were selected for testing as they are significantly different in terms of game characteristics (e.g., camera perspective, level of graphics detail). All games were played by using auto settings for video resolution and frame rate (i.e., under unimpaired conditions the quality was 1080p@60FPS), and auto settings for the network bandwidth (at the time of the study, the maximum bandwidth that the GFN service used was 30 Mbps). The participants were 15 adults (14 male and one female), aged between 22 and 33 (average age 25.93, median age 26). All participants were self-reported as highly experienced players.

Methodology

To invoke the adaptation, the following parameters were manipulated: latency, packet loss and bandwidth. The primary goal of the QoE study was to investigate how users rate overall QoE, perceived graphics quality, and perceived fluidity after service adaptation is invoked due to changing conditions. In accordance with the GFN service requirements and recommendations, three levels of packet loss (3%, 5% and 10%), and three levels of available bandwidth (20 Mbps, 10 Mbps and 7 Mbps) were used. Regarding latency, the goal was **not** to test the impact of different latency values, but rather to quantify the impact of the observed phenomena previously described corresponding to inserting additional latency into an already initiated gaming session. This was accomplished by testing three scenarios: 20 ms added **prior** to gameplay (denoted on results graphs as *20 ms (before)*); no latency; and the addition of 20 ms latency **during** gameplay

(denoted on results graphs as *20 ms (after)*).

Considering the 3 test scenarios for each of 3 parameters, tested across 3 games, the study included a total of 27 test scenarios. Test scenarios were tested by each participant, according to a randomized sequence (per parameter) to avoid possible bias and ordering effects (i.e., test scenarios corresponding to a certain parameter manipulation were grouped together). Only in the case of latency testing, scenarios were kept in the same order, adding 20 ms latency prior to gameplay, removing the latency, and then reintroducing the latency during gameplay. Before each of the gaming sessions, the participants were given a small amount of time to get acquainted with the tested games and their controls. After finishing each test scenario (which lasted between 30 seconds and 1 minute, depending on the game), the participants were instructed to fill out a questionnaire and report overall QoE, perceived fluidity, and graphics quality (all reported on a 5-point ACR scale). Additionally, players expressed their willingness to continue playing under the current test conditions.

Results

The average subjective scores for QoE and its features under various network conditions are shown in Figure 4.14. Concerning latency fluctuations during gameplay, results show that in the test cases when latency was reintroduced into the system after an already initiated gaming session, the average scores for overall QoE and its observed features were significantly lower than in test cases without artificial latency. This is particularly visible for the averages scores of graphics quality for Dirt 3, that were significantly lower in comparison with the other two games. Although Dirt 3 is a highly fast-paced game, the level of detail and overall graphics quality of the game was high enough that players can notice lower video resolution and frame rate values (i.e., video bitrate of 2 Mbps, and video quality of 540p@30FPS) that occurred as a result of service adaptation. Given that the added latency of 20 ms is very low and falls within the specified GFN requirements, it is clear that the corresponding QoE degradation is not a direct result of the latency, but rather the result of currently implemented GFN bandwidth estimation and service adaptation mechanisms. The same situation with the perceived gaming quality was apparent in other tested games, but to a lesser extent. These results show that inaccurate bandwidth estimation can lead to severe degradation in perceived quality for end users.

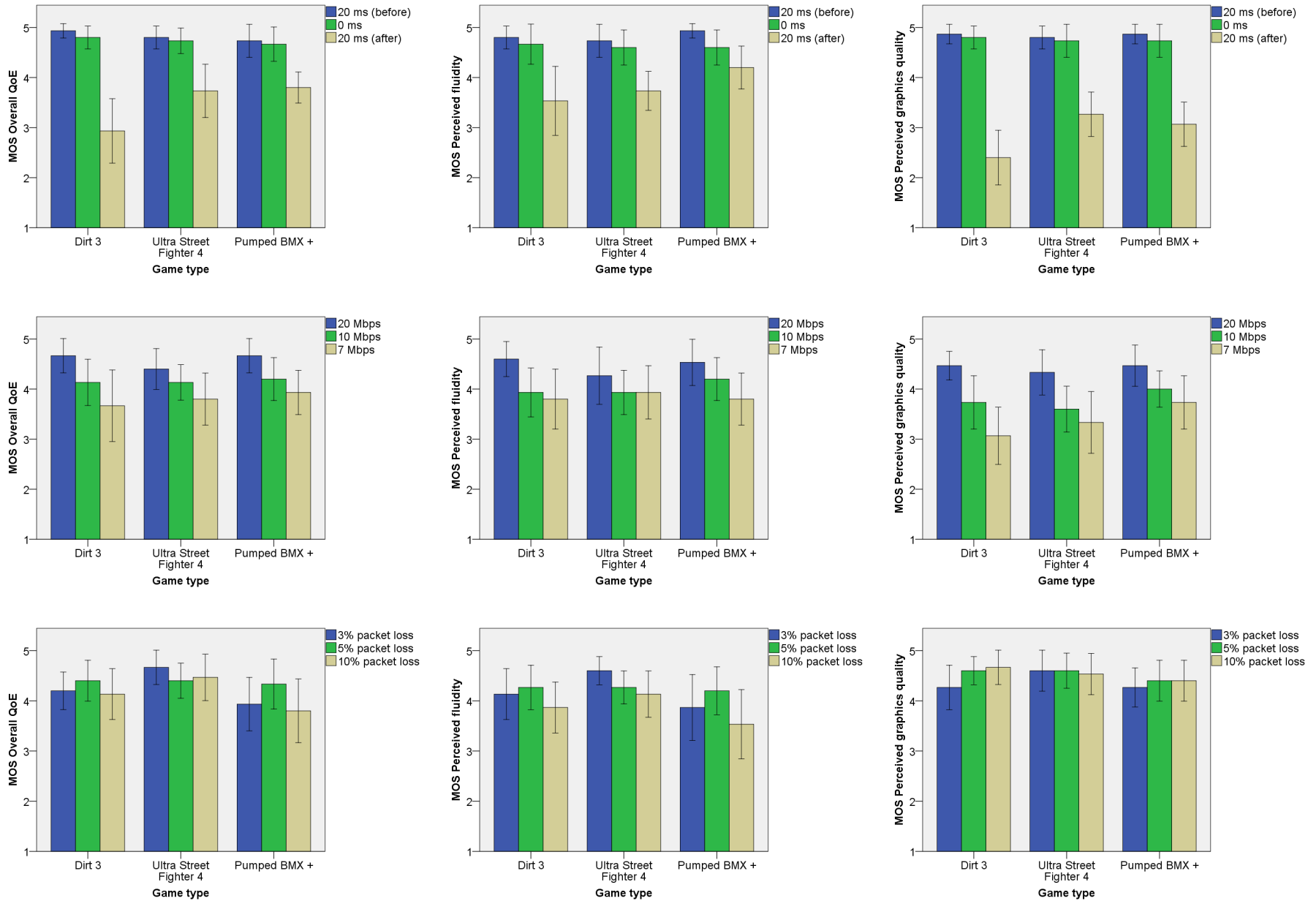

Figure 4.14: Subjective scores for QoE, perceived fluidity, and perceived graphics quality, across three tested games and under various latency, bandwidth availability, and loss conditions.

With respect to service adaptation due to increased packet loss, it is evident that even though the subjective scores were in general lower than in test scenarios when the service was running under “perfect” conditions, user ratings confirmed that the GFN service is very resilient to packet loss, without having to employ any service adaptation techniques. The impact of service adaptation strategies on users’ QoE due to different amounts of allocated bandwidth showed similar trends in the QoE assessment as in a case of the latency scenarios. The MOS scores for overall QoE decreased, likely due to lower graphics quality, while mean values of fluidity scores remained relatively high (MOS score around 4) for all tested games (the game never reduced the frame rate below 30FPS). The test participants verbally stated high overall satisfaction with gameplay under recommended conditions for amount of the bandwidth used by the service, while playing on minimum required bandwidth conditions was rated with lower, but still satisfactory scores. While reducing the bandwidth to 7 Mbps (below the minimum required by the GFN service) resulted with lower average QoE scores, it should be noted that for Pumped BMX + the MOS score was slightly below 4, which is quite high. This indicates the potential for overall bandwidth optimization strategies based on game characteristics. Additionally, Dirt 3 has once more on average lower scores in every evaluated QoE dimension, particularly in a case of graphics quality, in comparison with other two games.

Finally, Figure 4.15 portrays the willingness of players to keep playing under certain test conditions. The results clearly show that in the case of minimum added latency during gameplay, a significant percentage of players would opt to end gameplay, again confirming the potentially significant impact of bandwidth estimation and corresponding service adaptation algorithms on QoE, rather than the direct impacts of latency itself. Furthermore, results show that at bandwidth limitations of 7 Mbps, in total a significant portion of ratings showed players not willing to keep playing. However, when considering this issue on a per-game level, the per-game QoE scores indicate that for certain game types, such bandwidth limitations may be considered acceptable.

Summary of key findings: In this study we have evaluated the bandwidth adaptation strategy of NVIDIA’s GFN cloud gaming service based on a combination of both objective observations regarding adaptation behavior, as well as subjective user ratings under different network conditions. The GFN video codec sending rate is adjusted based on latency and bandwidth limitations, but not by packet loss. Given that service adaptation strategies are driven by client side bandwidth estimation algorithms, inaccurate estimations may result in severe QoE degradations due to the suboptimal configuration of video codec parameters. The reported observations may provide useful input for researchers and developers in terms of comparing and benchmarking cloud gaming adaptation strategies.

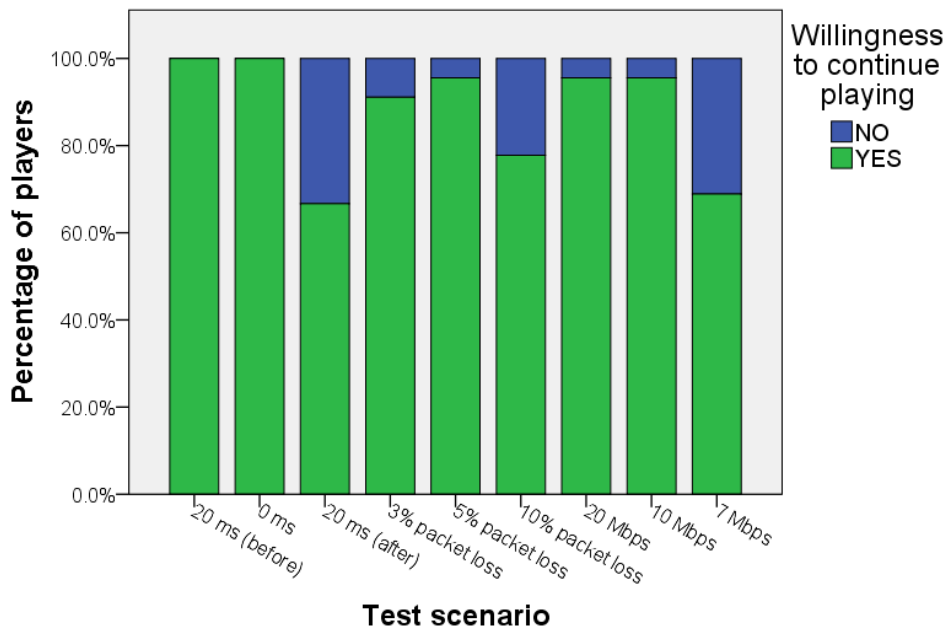

Figure 4.15: Willingness to continue playing (results aggregated across all games)

4.3 Chapter summary

Two QoE studies that investigated the impact of different network influence factors on user's QoE were presented in the chapter. Based on the results presented in the chapter, the following main findings can once again be highlighted:

- Positive participant's feedback during experiments showed that widespread use of in-home game streaming is possible if adequate video quality is guaranteed during streaming (Study S1).
- Given that GFN adaptation strategies are driven by client side bandwidth estimation algorithms, inaccurate estimations may result in severe QoE degradations due to the sub-optimal configuration of video codec parameters (Study S2).
- Despite the fact that a number of studies addressing cloud gaming QoE have recognized game genre as a key context QoE influence factor, state-of-the-art commercial solutions available at the time, such as GFN, did not take into account game genre while performing dynamic service adaptation due to resource availability constraints. In other words, based on our observations, the service applied the same adaptation strategy (in terms of adapting resolution, frame rate, and bitrate, regardless of the game type being played). One obstacle to performing game genre-aware adaptation is the lack of an existing classification of digital games based on objective game characteristics that could be used to categorize games for the purpose of assigning appropriate QoE-driven adaptation strategies.

The listed findings served as input for our subsequent studies, which then further focused on investigating the impact of video encoding parameters (bitrate, frame rate) on user's QoE.

Chapter 5

Impact of system factors and game type on QoE

Following our investigation of the impact of variable network conditions on the end user QoE, as well as initial investigation of video streaming adaptation strategies implemented in commercial cloud gaming solutions available at the time (presented in the previous chapter), our subsequent QoE studies further focused on assessing and modeling the impact of video streaming parameters. More specifically, the problem that was addressed in QoE studies S3-S6, described in this chapter, is how to adapt the video encoding parameters of the game video stream in light of decreased bandwidth availability, while maximizing the end user QoE. The test methodology, obtained results of the subjective studies and QoE models derived based on the results of the studies are presented in this chapter. Although latency and packet loss have significant impact on QoE for cloud gaming [23, 25, 29], further evaluation of their influence on QoE was considered out of the scope of these studies. Furthermore, our aim was to investigate whether games of different types require unique combinations of video encoding parameters for QoE maximization. Insight into how different video encoding parameters impact QoE for different games can be useful to cloud gaming providers in terms of potential resource savings (e.g., if QoE remains high even while decreasing frame rate to 25 fps for a certain type of game and available bandwidth, then there is no need to stream at 60 fps).

The adaptation of video encoding parameters based on bandwidth constraints which can arise in the network can be grouped into two major categories: reduction of the smoothness of gameplay, and reduction of the image quality. From conducted user study S2, presented in the previous chapter, it can be observed that NVIDIA's GFN indeed adapts frame rate (to adjust smoothness), and bitrate and resolution (to control image quality) in light of impaired network conditions. However, based on our observations, the adaptation implementation has its flaws and in some occurrences it leads to severe QoE degradations. In the case of Steam In-Home Streaming, the adaptation of video game streams is very limited. In the first iterations of Steam

In-Home Streaming, reduced bandwidth availability led to frame rate reduction. However, as of the time that our subjective studies were conducted, the platform's auto adaptation controlled only the image quality by reducing bitrate, while the resolution was unaltered and the frame rate was kept at a fixed 60 frames per second.

To evaluate how to adapt (or reconfigure) the video encoding parameters of the game video stream in light of decreased bandwidth availability for different game categories, four controlled subjective laboratory studies were conducted. Subsequently, reported empirical data acquired by way of questionnaires was analyzed by using appropriate statistical methods. As a result, derived QoE estimation models for tested games are presented in this chapter. It should be noted, as stated by Hong et. al [13], that such models as those reported in this chapter are not meant to provide overall accurate QoE estimations, as QoE is a complex construct with a wide range of context, human, and system influence factors, as well as QoE features. Rather, we narrow our scope to model QoE as a function of bitrate and frame rate for different types and categories of games and levels of player experience, with such models intended to provide input to the cloud service provider in terms of codec (re)configuration in light of available bandwidth. Moreover, such models may be utilized by network providers to optimize network resource allocation.

Table 5.1 gives a brief overview of the conducted studies and summarizes the main differences between the studies. Each of the subjective studies is then described in detail in the following sections as follows: Study S3 investigates the impact of bitrate and frame rate on QoE with only experienced gamers taking part in the study (Section 5.1); Study S4 extends these results by considering player skill in QoE model specification (Section 5.2), Studies S5 and S6 investigate whether or not the same video encoding adaptation strategy be employed for games from different genres (Section 5.3).

5.1 Study S3 - Impact of video encoding parameters on QoE

Study S3 aimed to answer research question **RQ1** as posed in the Introduction: "*How can the relationship between QoE and selected video encoding parameters (bitrate, frame rate) be quantified for cloud gaming?*". The study reported on an empirical user study examining the impact of frame rate and image quality settings under bandwidth constraints on the end user QoE. In particular, tests were performed in a controlled lab environment using Valve's Steam In-Home Streaming (re-branded as Steam Remote Play in 2019) [10]. While a number of previous studies were conducted using the open source GamingAnywhere platform [25, 41, 132], Steam's platform was selected in order to conduct tests using both commercial software, and also to enable comparison of different game streaming platforms. Conducted tests involved two distinct games, a popular first person shooter game known as *Serious Sam 3*, and an adventure

Table 5.1: Summary of differences between conducted user studies

Study	Year	Publication	Number of participants	Tested games	Bitrate levels	Frame rate levels
S3	2015	Slivar <i>et al.</i> [14]	15 (all experienced)	Serious Sam 3, Bastion	3 Mbps, 5 Mbps, 10 Mbps	15 fps, 20 fps, 25 fps, 30 fps
S4	2015	Slivar <i>et al.</i> [15]	52 (16 novice, 22 intermediate, 14 experienced)	Serious Sam 3, Hearthstone	3 Mbps, 5 Mbps, 10 Mbps	25 fps, 35 fps, 45 fps, 60 fps
S5	2016	Slivar <i>et al.</i> [35]	28 (8 novice, 9 intermediate, 11 experienced)	Serious Sam 3, Orcs must die: Unchained!	3 Mbps, 5 Mbps, 10 Mbps	25 fps, 35 fps, 45 fps, 60 fps
S6	2018	Unpublished	39 (12 novice, 19 intermediate, 8 experienced)	Heroes of the Storm, Bastion	3 Mbps, 5 Mbps, 10 Mbps	25 fps, 35 fps, 45 fps, 60 fps

platform game known as *Bastion*. The image quality and gameplay smoothness were varied under fixed bandwidth constraints to evaluate whether there is a difference between tested games and whether different adaptation strategies should be applied for each game to maximize QoE under bandwidth restrictions.

5.1.1 Methodology

The study consisted of an hour and a half long gaming sessions that were conducted in a laboratory environment as shown in Figure 5.1. As previously stated, Valve’s Steam In-Home Streaming was selected to test a commercial grade game streaming service. As the focus was on assessing the impacts of different bitrate and frame rate settings on QoE, further loss and delay degradations were excluded by conducting tests in a controlled network environment. Steam desktop clients were installed on all three PCs (Windows 7 desktops, each with Intel 3.3 GHz i3 processor, 4GB RAM and GIGABYTE Radeon R7 250), which included implementation of the Steam In-Home Streaming service. PC 1 acted as a server, while the other two PCs (PC 2 and PC 3) were used as clients of the same service. This particular laboratory set-up enabled high quality video streaming of game content from the server to the client in a local area network (100 Mbps Ethernet), mitigating network limitations (related to cloud gaming) and allowing to play computer games on low hardware powered devices that usually could not run high-end graphics-intensive games.

Two games from different game genres were played in the study: *Serious Sam 3 (SS3)* as an example of a fast paced first-person shooter game, and *Bastion* as a representative of the action

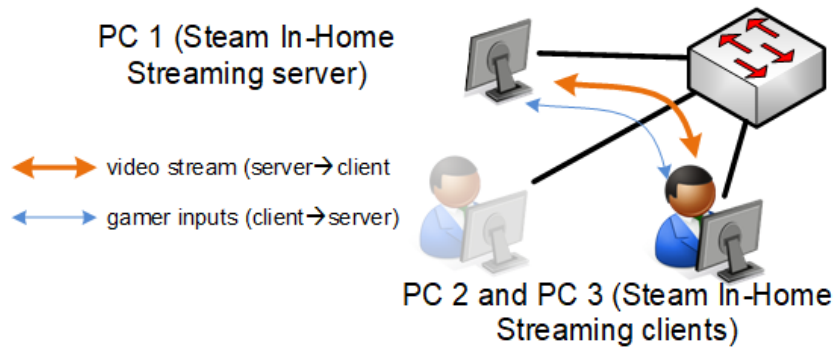

Figure 5.1: Laboratory testbed used in Study S3

role-playing genre, thus analyzing two games that differ in camera perspective, graphics style and quality, gameplay pace, and the intensity of user interaction. Both games were played at the default graphics settings and resolution was set to 1280x720 (720p).

Given that previous studies have shown that user gaming experience is an important factor influencing QoE ratings [21], tests were conducted using a homogeneous group of self-reported experienced players, as such players have been shown to be the most demanding in terms of QoE requirements. The participants were 15 male adults, aged between 23 and 32 (average age 26, median age 27), all with more than 10 hours playing time per week. Prior to testing, participants were asked to report their previous gaming experiences, with emphasis on considered games in the study. 87% reported having prior experiences with playing SS3, and 40% reported having previously played Bastion.

In this experiment, two video encoding parameters (shown in related studies to have a high impact on cloud gaming experience [13]) were manipulated: bitrate and frame rate. By setting the target bitrate value and changing the frame rate, the image quality was indirectly controlled due to H.264 coder's rate control mechanism. It is a typical trade-off mechanism, as setting a lower frame rate value leads to a less smooth game experience and can introduce so-called *jerkiness* of the graphics during gameplay, but enables the use of more bits per pixel in a single frame, thus increasing the image quality. The goal was to identify at which point the balance of these two parameters yields the highest QoE value for a given bandwidth threshold. Manipulation of these video encoding parameters was done using Steam's developer console (manipulation of frame rate) and In-Home Streaming client GUI settings (manipulation of bitrate).

Four levels of video frame rate were used during the experiments: 15 fps, 20 fps, 25 fps, and 30 fps. These video frame rate values were chosen based on a previous study [139] which showed that serious degradation of the gaming experience and user's game performance occurred when video frame rate was below 15 fps. Also, during testing sessions prior to this study, we noticed that the Steam platform does not support streaming of SS3 with frame rates lower than 15 fps, so we used this as a minimum value. Furthermore, three levels of video bi-

trate were selected for testing purposes: 3 Mbps (minimum bitrate enabled by Steam), 5 Mbps, and 10 Mbps.

With four frame rate levels, three bitrate levels, and two different games, ratings were collected for a total of 24 different test conditions. All conditions were tested by each participant, with the sequence of test scenarios randomly selected for every player to avoid possible ordering effects and bias of manipulated video encoding parameters. The participants were instructed that they were playing games using Steam's streaming service. At the beginning of each game session, participants were given a small amount of time (tutorial phase) to familiarize themselves with a chosen map and gameplay mechanics of each game. The first 12 test scenarios consisted of playing one round of *Serious Sam 3* survival mode on a single map. While the participants were playing on one of the client PCs (PC 2 or PC 3), a test administrator changed video encoding parameters on the second client PC for the next test scenario - this was done to speed up the test procedure. Each of the twelve SS3 test scenarios was 2-3 minutes long, depending on how long a given participant lasted on the map without their avatar "dying".

After finishing each test scenario, players were instructed to fill out a questionnaire about their perceived graphics quality, perceived fluidity, and overall QoE (all reported on a 5-point ACR scale). In addition, participants were asked to report their willingness to continue playing under the current test conditions (yes/no). The test administrator further noted the amount of time participants spent during this test scenario. After filling out the questionnaire, players switched to playing on the other client PC under different test conditions (only one video stream was active at once). The second half of the test scenarios consisted of playing *Bastion's* score mode on a single map. One run of *Bastion* on a single map contained three checkpoints where participants paused their gaming progress (approximately after 2 minutes of playing time), filled out a questionnaire and continued playing on the other PC. Once again, the test administrator recorded the number of player deaths and obtained game score during each test scenario. The entire gaming session lasted approximately 1.5 hours.

5.1.2 Results

The average subjective ratings of overall QoE for both tested games and across all test conditions are shown in Figure 5.2. Overall QoE for both games during test scenarios with 15 fps was notably lower than during test scenarios with higher values of frame rate, thus confirming findings of previous studies claiming that this frame rate value should be considered a minimum threshold value. Furthermore, no significant differences were observed in ratings for both games between test conditions with 30 fps and 25 fps, thus indicating that even highly skilled players do not notice small frame rate drops while playing games with high overall frame rate values such as 25-30 fps. It should also be noted that SS3 has on average higher scores of QoE for all frame rate levels in comparison with *Bastion*, except for test scenarios with 15 fps. This

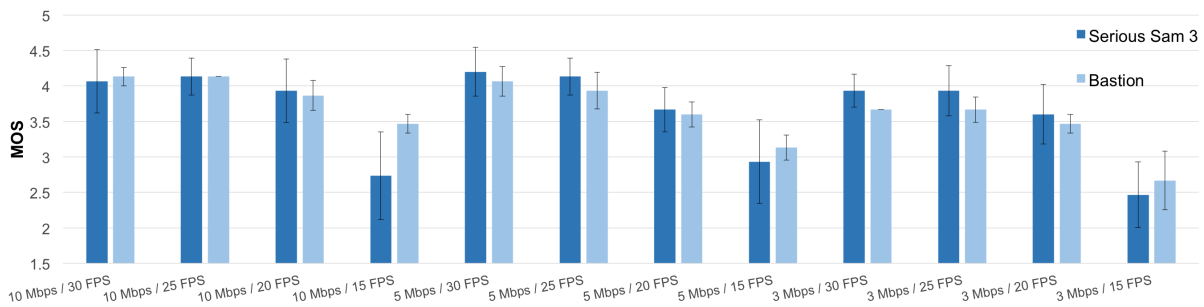

Figure 5.2: Subjective ratings of overall QoE (95% CI) for tested games in Study S3

can be attributed to fluidity being a more influential QoE dimension for first-person shooter games as compared to slower paced games. Furthermore, reducing video bitrate under fixed frame rate had more significant degradation on Bastion then on SS3 (keeping in mind that the lowest bitrate tested was 3 Mbps). This can likely be attributed to graphics degradations being more perceptible in Bastion then in SS3. It should be noted that potential order effects may have occurred during experiments due to the experimental design (order of games being tested).

Figure 5.3 provides a heat map overview of all collected mean subjective ratings of QoE features for both games during different test conditions. In terms of graphics quality, ratings naturally decreased with decreasing video bitrate values for both games. However, the impact of graphics quality was weaker for SS3 than Bastion, which can be linked to players' perceptions of graphics impairments being hindered by the fast-paced nature of the game. It can be noted that the test results show that subjective graphics ratings did not increase with lower frame rates, which is contrary to the initial assumptions and also to the results reported in [13]. This contrary finding could be attributed to different games used in both this study and study [13], and/or to the smaller sample size in this study. The data further shows that frame rate had more impact on perceived fluidity while playing SS3 then while playing Bastion, which is expected considering the difference in the dynamics of gameplay.

Additionally, statistical relationships between overall QoE (and its features) and video encoding parameters were reported in Table 5.2. To measure linear correlations, Pearson's product moment correlation coefficient r was computed. The data shows significant positive correlations between overall QoE and frame rate for both games, and between frame rate and perceived fluidity. Video bitrate had significant correlations with perceived graphics quality, while no correlations were found between bitrate and overall QoE for SS3. Furthermore, it can be noted that there were not found any correlation or any statistically significant relationship between objective game metrics (survival time for SS3, number of deaths and score for Bastion) and manipulated video parameters/subjective ratings.

As previously mentioned, participants were also asked after each test scenario to express their willingness to continue playing the game under the test conditions in a given scenario. Results are shown in Figure 5.4. For test scenarios that involved playing SS3, it can be ob-

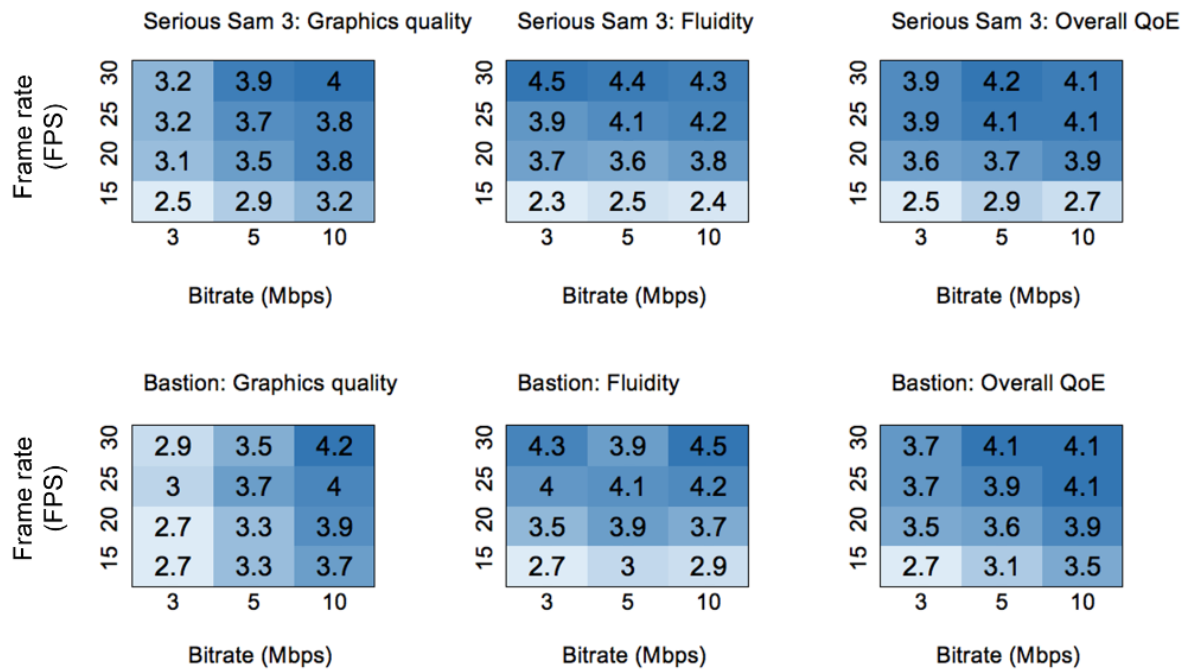

Figure 5.3: Aggregated subjective ratings for each tested game in Study S3 under different video configurations

Table 5.2: Correlations between ratings and video parameters (***) p -value < 0.001, ** p -value < 0.01, * p -value < 0.05)

		Overall QoE	Graphics quality	Fluidity
Serious Sam 3	Frame rate	$r = 0.504$ ***	$r = 0.289$ ***	$r = 0.625$ ***
	Video bitrate	$r = 0.079$	$r = 0.258$ ***	$r = 0.020$
Bastion	Frame rate	$r = 0.370$ ***	$r = 0.137$	$r = 0.473$ ***
	Video bitrate	$r = 0.237$ **	$r = 0.421$ ***	$r = 0.07$

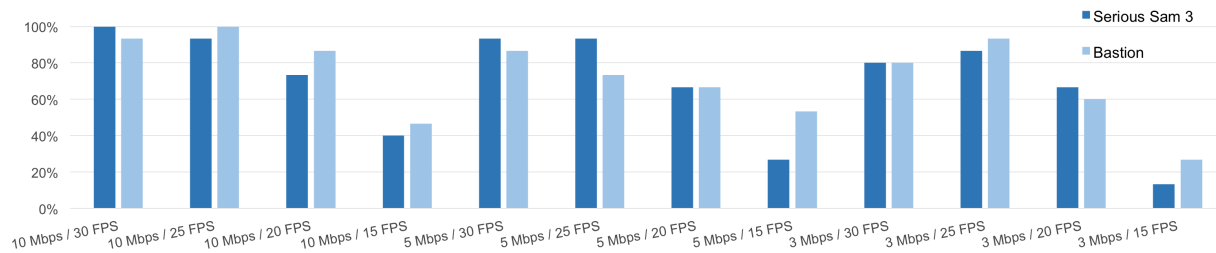

Figure 5.4: Percentage of players willing to keep playing under different test conditions for tested games in Study S3

served that the percentage of players that are willing to continue playing declines with lower frame rates during experiments, with less than 40% of players willing to keep playing at 15 fps (regardless of bitrate down to 3 Mbps). There was no significant difference in the percentage of players that were willing to continue playing between test conditions with 30 and 25 fps, once more confirming the finding that even more experienced players are not aware of game performance degradations at these frame rate levels. Furthermore, it can be observed that lowering bitrate did not have any effect on the users' willingness to keep playing, meaning that the streaming platform could without serious repercussions allocate the minimal amount of bandwidth (in this case 3 Mbps) for the addressed game types. In comparison, for test scenarios that involved playing Bastion at 10 Mbps, it can be noted that by lowering the frame rate, participants' willingness to play decreased, but that percentage remained on average higher than the percentage of players that did not want to continue playing SS3 under the same test conditions.

Reported results in this study can be compared with respect to continuation of play to the results of the GamingAnywhere platform at the same bitrate reported in [25] (Study S1). For both Steam and GamingAnywhere at bitrates of 3 Mbps, around 80% of the players were willing to continue playing, although the games under test are different. In Study S1, the Massive Multiplayer Online Role Playing Game (World of Warcraft) was tested, while in Study S3, a first person shooter and an adventure platform game were tested. This confirms that GamingAnywhere was at the time comparable with a commercial product at speeds of 3 Mbps.

5.1.3 QoE model for a fast-paced game

The collected data was used to derive multiple linear regression models (by using ANOVA), modeling overall QoE both in terms of independent manipulated video encoding parameters, and in terms of dependent QoE features for both games, as shown in Figure 5.5. The goal was to analyze how each of these predictors, and to what magnitude, contributes to the overall QoE. It should be noted that the data was considered as interval data and not ordinal (i.e., the intervals between points on the rating scales were considered equal). Also, while results of some test scenarios showed skewness and kurtosis, and some of the test cases have not passed normality

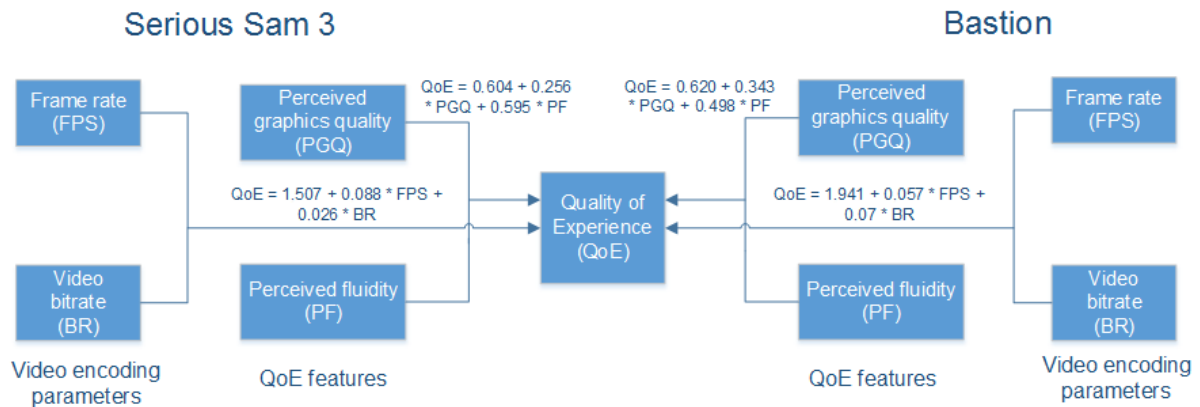

Figure 5.5: Summary of linear regression models for QoE with video parameters and QoE features for tested games in Study S3

tests, ANOVA is considered quite robust on non-normality violations [135], and has been used for analysis of this type of data frequently in related work. Nevertheless this information should be taken into consideration when using the obtained model. ANOVA results (of video encoding parameters) for SS3 show that only frame rate had a significant impact on QoE (p -value < 0,001), while video bitrate was statistically insignificant (p -value > 0.05).

This can be attributed to the high frequency of game screen changes characteristic for first person shooter games distracting players from observing graphics degradations caused by lowering video bitrate, and due to players being sensitive to the smoothness of the delivered game video content. This analysis showed that one potential way to increase/preserve perceptible QoE of first-person shooter games is to keep video frame rate at a reasonably high level, even at lower bitrates. The accuracy of the aforementioned prediction model for QoE for SS3 is shown in Figure 5.6. QoE for SS3 was further modeled as a weighted linear combination of graphics quality and fluidity (Figure 5.5). Both predictors had a significant impact on QoE (p -value < 0,001), with fluidity having a significantly stronger impact, as expected from prior findings. The R^2 value is 0.72.

5.1.4 QoE model for a slow-paced game

Analogously, the same procedure was repeated for Bastion, with models also shown in Figure 5.5. The model shows that both frame rate and bitrate had a significant impact on QoE (p -value < 0,001), with frame rate having a significantly stronger impact. Before conducting experiments, the expectation was that video bitrate (and with that, graphics quality) would contribute more to overall QoE than video frame rate, in accordance with Bastion being a slower-paced game with very detailed graphics. It was also anticipated that the test group would be more affected by degradations of graphics quality induced by lowering the bit rate and by improvements in graphics quality due to lower frame rate.

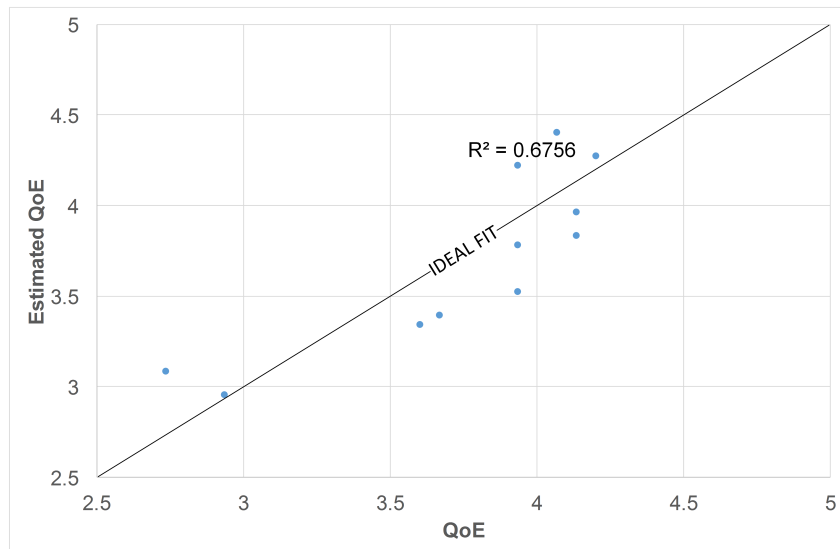

Figure 5.6: Accuracy of predicted QoE ratings vs subjective QoE ratings collected in Study S3 for Serious Sam 3

The accuracy of the model is shown in Figure 5.7. A prediction model for Bastion with gaming QoE features as predictors is shown in Figure 5.5, with an R^2 value of 0.66. As in the case of SS3, both of the QoE features were found to have a significant impact on QoE (p -value $< 0,001$), with fluidity again having a significantly stronger impact, but not as strong as in the SS3 prediction model.

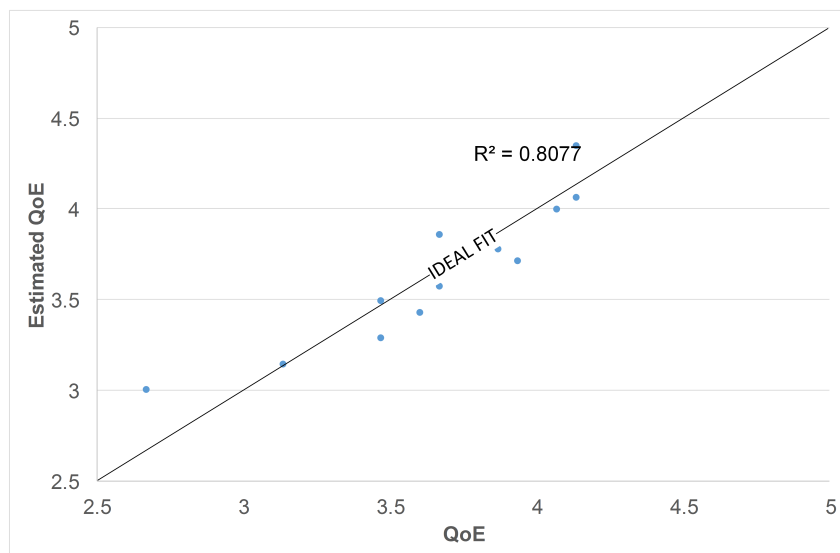

Figure 5.7: Accuracy of predicted QoE ratings vs subjective QoE ratings collected in Study S3 for Bastion

Based on the presented results in the section, **the following key findings** can be highlighted for Study S3:

- Lowering frame rate down to 25 fps does not significantly degrade the gaming experience regardless of the game,
- Bitrate reduction has a more significant impact on Bastion than on SS3, while in the case of frame rate the situation is reversed,
- While differences between games exist, fluidity has a more significant impact on QoE for both investigated games than graphics quality under the same bitrate constraints - we did not find cases in which reduction of frame rate resulted in increased QoE.

5.2 Study S4 - Should different adaptation strategies be applied for different types of games?

Study S4 was designed so as to build on both the results reported in [13] and in our Study S3 [14]. The aim was to answer research question **RQ2**: “*How should video encoding parameters of the game video stream be adapted (or reconfigured) in light of decreased bandwidth availability, so as to maximize QoE?*”. As a result, subjective data was collected to specify video encoding adaptation strategies applicable in the context of cloud gaming, with the aim of maximizing QoE. Empirical results obtained from a controlled subjective laboratory study involving 52 participants and two game types were used to analyze the impact of manipulated video encoding parameters (bitrate and frame rate) on the players’ QoE. Obtained data was subsequently used to investigate the impact of contextual factors including game type and player skill on QoE model specification, and to derive analytical QoE estimation models as functions of bitrate and frame rate, while concrete adaptation strategies are discussed in Chapter 7.

5.2.1 Methodology

The QoE study consisted of participants taking part in two and a half hour long gaming sessions that were conducted in a laboratory environment as shown in Figure 5.8. Valve’s Steam In-Home Streaming was used as the cloud gaming environment, the Steam client application was installed on all PCs in the laboratory, thus converting PC1-PC4 (Windows 7 desktops, each with Intel 3.3 Ghz i3 processor, 4GB RAM and GIGABYTE Radeon R7 250 graphic card) to Steam In-Home Streaming clients (cloud gaming clients) and PC5-PC8 (Windows 8 desktops, each with Intel 3.6 Ghz i7 processor, 8GB RAM and ASUS GT740 OC graphic card) to Steam In-Home Streaming servers (cloud gaming servers). Each of the clients had a corresponding

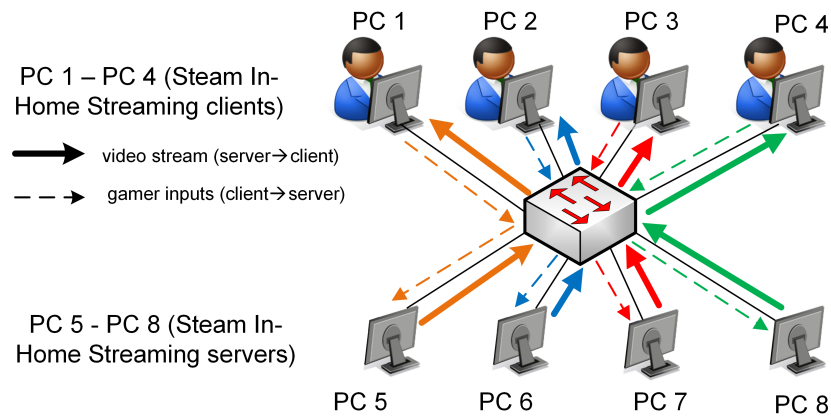

Figure 5.8: Laboratory testbed in Study S4

Steam In-Home Streaming server associated, therefore four participants were able to play simultaneously during the experiments.

Two games were played in the study as follows: *Serious Sam 3*, representing a fast paced first person shooter game, and *Hearthstone (HS)*, a relatively slow paced card game. The differences between these two games are illustrated in Figure 5.9 and according to the following characterization dimensions (inspired by the categorization given in [11]): number of players, input rate, gameplay pace, camera perspective, graphics detail, and mobility of avatars. The intended use of the figure is to visualize (in a straight forward manner) fundamental differences between the studied games. It should be noted that portrayed dimensions are not necessarily orthogonal, and that not all values of these dimensions may be feasible in a game spectrum. Each dimension is divided into five levels, except for camera perspective, which is divided into three levels based on [16]. The number of players is divided into five levels (from 1 to 5): single player games, two-player games, games intended for up to ten players, games intended for up to 100 players, and games for more than 100 players. In this dimension HS is placed into category 2 and SS3 into category 3. Input rate is divided based on average action per minute rate (APM) into the following categories: <10 APM, between 10 and 20 APM, between 20 and 30 APM, between 30 and 40 APM, and 50 and more APM. In this dimension HS is placed into category 1 and SS3 into category 5. The gameplay pace is specified based on the rate of the events in the game which require player reaction. In this dimension, HS is placed into category 1 as the pace is very low (usually players need to react to 1 or 2 events in 70 seconds). SS3 is placed into category 5 as the rate of events (i.e., attackers in the game) can be even multiple in one second. Presented games were selected for the study as they represent two ends of the spectrum on many of the defined dimensions. Both games were played in HD-ready resolution (720p) with default graphics settings.

The participants in the subjective tests were 52 students enrolled at the University of Zagreb, 38 male and 14 female adults, aged between 21 and 26 (median age 23). Prior to the

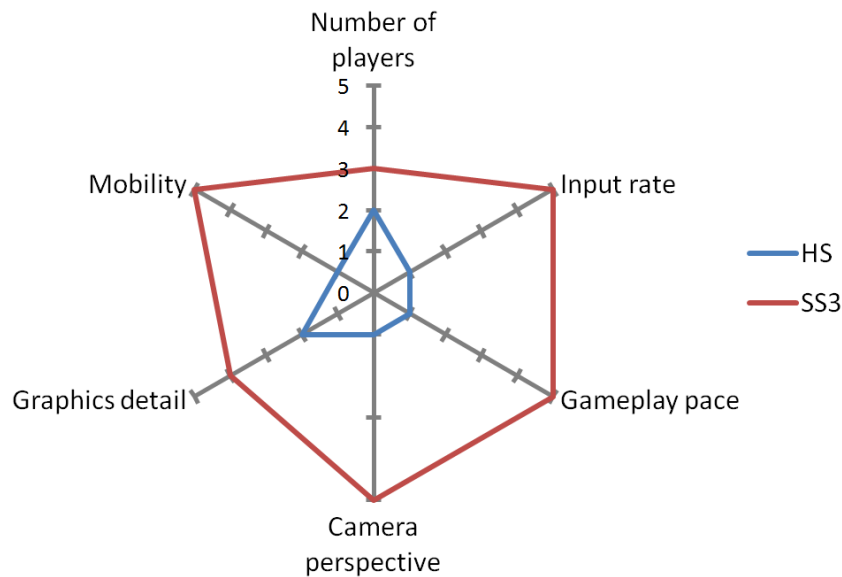

Figure 5.9: Comparison of game characteristics for Serious Sam 3 and Hearthstone. Points on the different axis represent different levels as described in the text.

experiments being conducted, the participants were instructed to fill in an online questionnaire, so as to obtain relevant information about their previous overall gaming experience and gaming experience relevant to the tested games. As a result, 16 novice, 22 intermediate skilled, and 14 self reported experienced players took part in the study. Since previous studies for traditional online gaming have shown that players' group composition based on previous gaming experience has an impact on perceived QoE [21], test groups were formed accordingly to investigate if this phenomenon occurs similarly in cloud gaming. The participants were organized in 13 groups with 4 players in each group, based on their reported gaming experience (skill). Each of the formed heterogeneous groups had one novice and one experienced player, while homogeneous groups consisted of 4 players with the same gaming skill level. One of the reasons for letting participants play together in groups was that for less experienced players, it was expected to be more interesting and enjoyable to play in groups with other colleagues. Moreover, allowing players to play in groups rather than alone may be considered more representative of a real-world scenario. However, it is important to acknowledge that controlling the social factors (communication between players and variable session length based on their performance) in this situation is more difficult and might have adverse effects on the results (note that previous studies [21] showed that the quality of gaming can be rated differently when mixed player groups are used in experiments). In future studies, an option may be to use an AI or expert gamer playing as an opponent to mitigate the impact of this social influence factor.

As stated previously, the focus in this study was not on analyzing the impact of network parameters on cloud gaming (as has been addressed in many previous studies), but rather on the investigation of the impact of video encoding parameters on QoE, with a focus on the cloud

game provider perspective. Therefore, video frame rate and bitrate were manipulated, consequently controlling/influencing image quality and smoothness of gameplay. The aim was to investigate how and to what extent these parameters affect perceived QoE for different types of games, with the ultimate goal being to use this information to derive video encoding adaptation strategies and optimized resource allocation (from a network/service provider standpoint), while at the same time preserving high QoE. For the manipulation of video frame rate, four levels of frame rate were used: 25 fps, 35 fps, 45 fps and 60 fps. In the aforementioned previous studies [13, 14], the lower end of the fps spectrum was investigated, so relatively higher values of frame rate were selected in this study, which coincides with the expectations of average experienced gamers regarding video frame rate. As far as video bitrate is concerned, three levels were selected for the experiments: 3 Mbps, 5 Mbps and 10 Mbps. The average bitrate received by the client during the experiments corresponded to the server settings, even though in some cases (e.g., low-motion video), the average bitrate was slightly lower than the settings. For encoding parameters, the video resolution always stayed the same (720p), while for other parameters (e.g., quantization parameter (QP), rate-distortion (RD)) it can be assumed that the system adapted them accordingly (e.g., lowering frame rate at the same bitrate results with better graphics quality). However, due to the fact that we were unable to access detailed information regarding additional video coding parameters manipulated by the Steam platform, we refrain from drawing further conclusions. Both frame rate and bitrate were manipulated through Steam's developer console.

It should be noted that the extent of the study was limited by a certain number of test conditions, constrained by the length of subjective testing sessions. Additional test conditions would potentially lead to overly lengthy gaming sessions and possibly player fatigue. The chosen test conditions were based on the aim to complement previous studies, in the sense that the study addressed conditions under which the impact of different bitrate/frame rate combinations on QoE has not been well studied. Furthermore, prior to the user study, tests were conducted to check if the testbed set-up has sufficient hardware and software capabilities necessary to support all tested games and conditions. Performance (frame rate) of the testbed was measured for each tested condition and it proved sufficient for all conditions.

Considering manipulated video encoding parameters and different games, a total of 24 different test conditions were investigated during this study, with all conditions tested by each test group. During one test scenario, all players tested the same conditions (i.e., video encoding parameters). To avoid bias of manipulated video parameters, the sequence of test scenarios was randomized for each group. At the very beginning of the experiment, the participants were familiarized with the concept of cloud gaming and the Steam In-Home Streaming service. All the participants from each test group were seated in the same experimental room, with PCs located next to each other in one row (the participants could see each others screens and communicate

with each other during experiments). Before tests started, the participants were given a short time to familiarize with game specific mechanics and the chosen map. The first 12 test scenarios involved playing one round of SS3 cooperative survival mode on a single map. During these test scenarios, it was expected from the participants to cooperate with each other to survive longer on the map. Each of these 12 test scenarios lasted on average from 2 to 5 minutes, depending on how long players from the test group survived. After finishing each test scenario, the participants were instructed to report *overall QoE*, *perceived graphics quality* and *perceived fluidity of gameplay* (on a 5-pt. ACR scale). Fluidity was explained as referring to the perception of the smoothness in the rendering of the virtual scene. Additionally, participants also reported their willingness to continue playing under the given test conditions for the current test scenario (yes/no). The survival time was also recorded for each player. While participants were filling in questionnaires, the test administrator changed the video encoding parameters by running scripts on the player's PCs.

The second half of the experiment involved playing HS. HS is a digital card game that consists of turn-based matches between two players. For that reason, an opponent from the group was assigned to each player by the test administrator. In the case of HS, each test scenario lasted 3 minutes, after which the participants filled in a questionnaire and continue playing the ongoing match. The entire gaming session (with a 10-minute break allotted in the middle) lasted approximately two and a half hours, depending on the group's performance during the SS3 test scenarios. It should be noted that potential order effects may have occurred during experiments due to the experimental design (order of games).

5.2.2 Results

Figure 5.10 shows the average subjective ratings of overall QoE for SS3 and HS across all test conditions. First of all, it can be observed that there is a visually significant difference between overall QoE for both games: HS had on average higher scores of overall QoE for all test conditions in comparison with SS3, with the average QoE score never going below 4.0 for any given test scenario. A one-way ANOVA was used to determine whether there are any statistically significant differences between the means of two tested games. It should be noted that the data is considered as interval data and not ordinal (i.e., the intervals between points on the rating scales are equal). One-way ANOVA indeed confirmed the observation that there was statistically significant difference between QoE scores for tested games ($F = 415.26, p < 0.05$).

Moreover, it can be noticed that manipulation of video encoding parameters significantly affected perceived QoE for SS3 gaming sessions (one-way ANOVA results: $F = 13.198, p < 0.05$): when bitrate values were high enough (10 Mbps), lowering frame rate led to degradations of QoE. SS3 is a representative fast paced first person shooter game, thus degradations of fluidity (smoothness of gameplay), introduced by lowering frame rate, had a higher impact

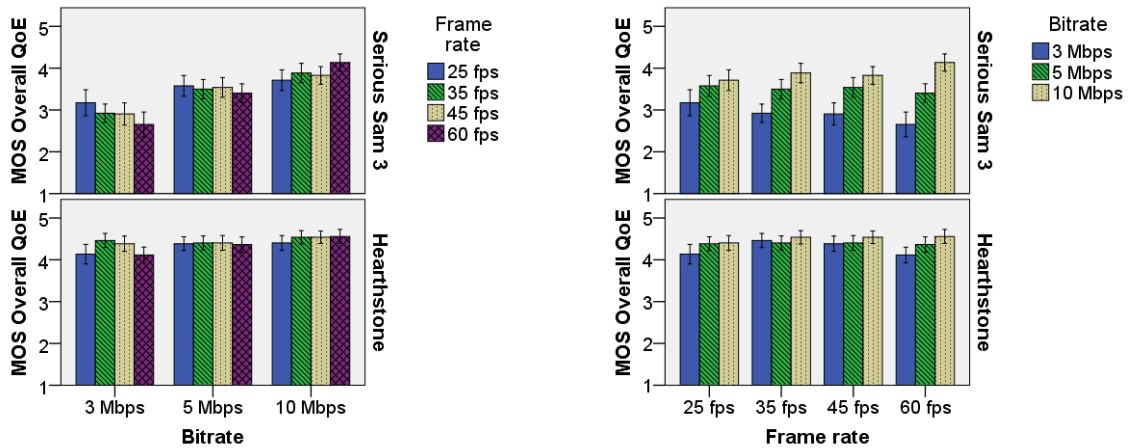

Figure 5.10: Subjective ratings of overall QoE (95% CI) for tested games in Study S4

when the bitrate was high enough to support transmission of high quality video. However, for low bitrate levels (3 Mbps), average scores of perceived QoE were ascending with reductions of frame rate (down to 25 fps). This can be attributed to the fact that 3 Mbps bitrate is not high enough to preserve *good enough* video quality, so even though fluidity is very important for fast paced games, the participants do not tolerate low graphics quality and thus prefer an increase in graphics quality at the expense of lowering the fluidity of gameplay for these scenarios. On the other hand, it can be observed that neither lowering video frame rate nor video bitrate had such a severe impact on perceived QoE during HS gaming sessions (average QoE score for all test scenarios is above 4.0), though the results of one-way ANOVA indicate statistically significant difference between QoE scores for different video codec configurations ($F = 2.524, p < 0.05$). We can assume that during our experiments, the manipulated frame rate and bitrate values were high enough that the participants did not perceive QoE degradations for HS. Given these results, we conclude that *different video encoding strategies may be employed for different games to maintain high player QoE*.

Besides collecting data about overall QoE scores, data about user perceived fluidity and graphics quality was also collected (such measures have also been reported in related work [13]). A heatmap overview of collected data (Figure 5.11) shows the mean scores for overall QoE, graphics quality, and fluidity. Spearman's rank-order correlation was computed to determine the relationship between overall QoE and measured QoE dimensions. There is a very strong, positive correlation between overall QoE and fluidity ($r_s = .811, p < .001$), and overall QoE and graphics quality ($r_s = .809, p < .001$) indicating that players form an opinion about the test scenario and score the different dimensions based on this opinion. It can be noticed that the HS MOS score for overall QoE and its features (fluidity, graphics quality) were on average much higher and were prone to minor changes due to manipulation of video parameters in comparison with MOS scores for SS3. This further supports the claim that the majority of

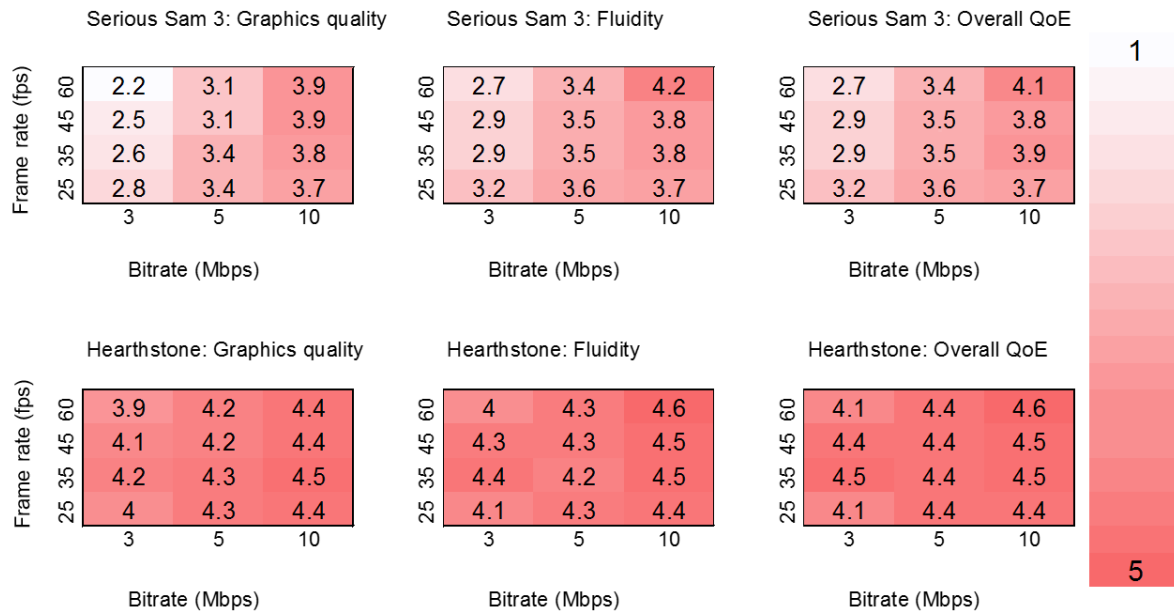

Figure 5.11: Aggregated subjective ratings for each tested game in Study S4 under different video configurations

players do not easily perceive QoE degradations while playing a slow paced game such as HS at a higher spectrum of test conditions.

In addition to differences in aggregated scores, there was also a large discrepancy in the number of test scenarios where the participants were not willing to continue playing under current test conditions between tested games, as shown in Figure 5.13: for SS3, there were 218 occurrences (from 624 overall) when players stated they would not continue playing under the given conditions, while for HS there were only 13 cases (from 624 overall) when players stated they would quit playing. It can be observed that for 3 Mbps and 60 fps, 73.1% of players were not willing to continue playing SS3, while for HS under the same test conditions only 1.9% players wanted to quit playing. Additionally, it can be noticed that at a bitrate of 3 Mbps, a decrease in frame rate actually resulted in an increase in the percentage of players reporting they would continue playing SS3, whereas for HS the same manipulation of frame rate did not result with such an increase in the percentage of players willing to continue playing. This furthermore confirms the need for deriving video encoding adaptation strategies for different types of games when aiming to optimize end user QoE.

Given the length of the user study (2.5 hrs), we further tested whether there was an impact on user fatigue and trends in user ratings from beginning to the end of the test session. Thus, the overall user ratings for conditions tested early in the test session and those tested late in the session were compared (note test ordering was randomized). No clear differences or trends were observed.

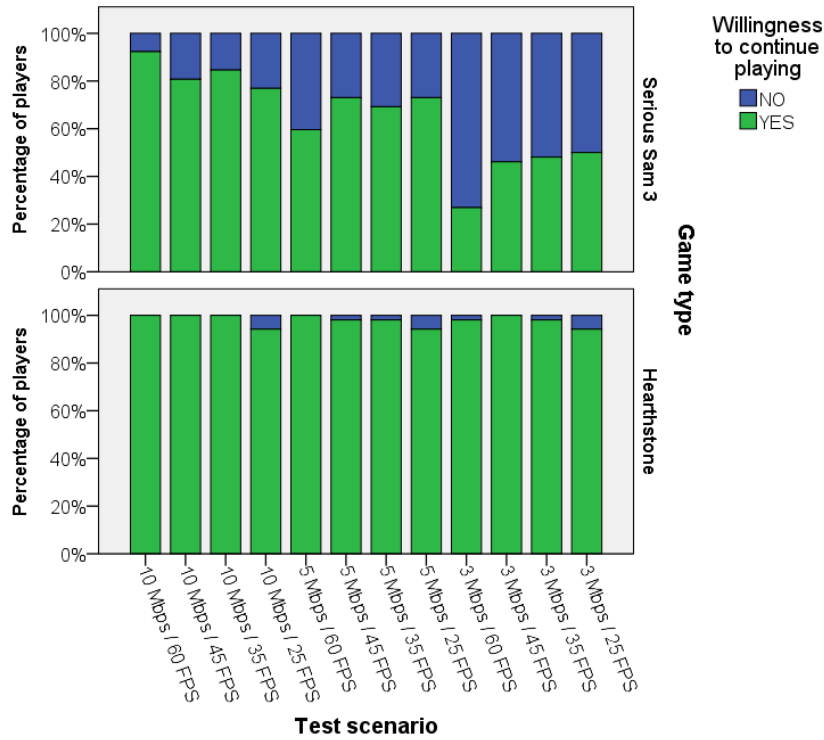

Figure 5.12: Willingness to continue playing under different test conditions for both tested games in Study S4

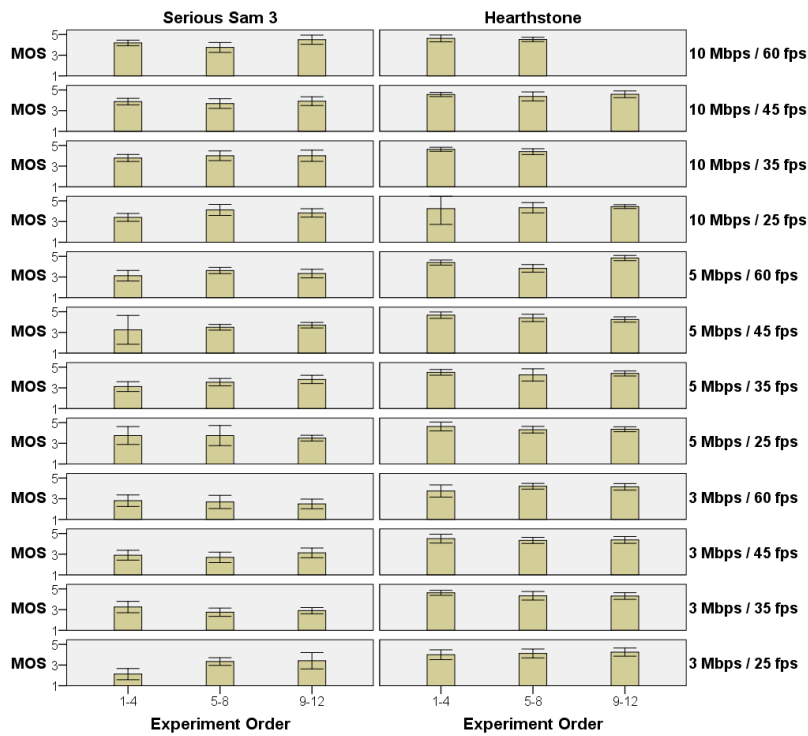

Figure 5.13: Average user ratings for QoE depending on the test condition order in the experiment for both tested games in Study S4

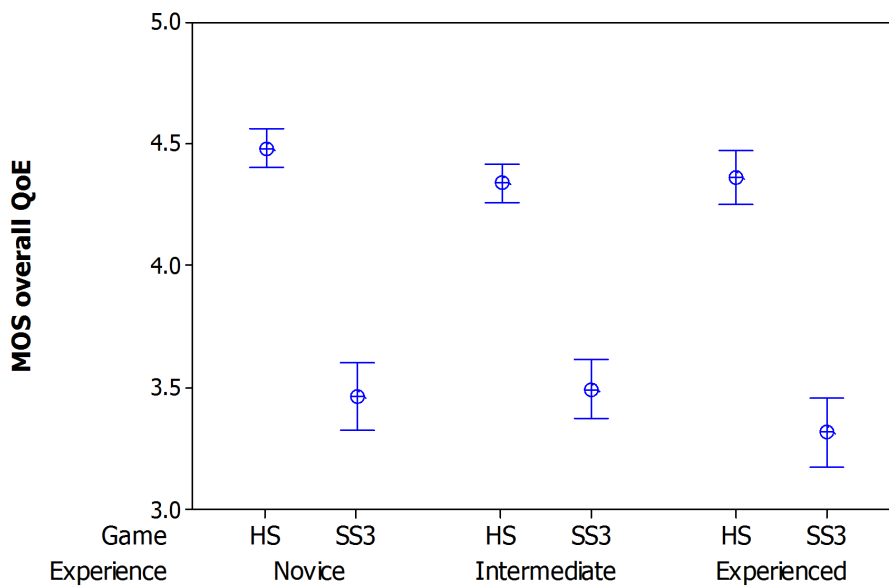

Figure 5.14: Subjective ratings of overall QoE (95% CI) for SS3 and HS grouped by skill

User parameters

Another goal of the study was to examine the impact of user parameters on QoE, primarily in terms of player's previous gaming experience. Overall QoE ratings for SS3 and HS grouped by player experience are shown in Figure 5.14. While experienced players gave on average slightly lower QoE scores in accordance with the introduced QoS degradations in comparison with less experienced players, the confidence intervals are overlapping so no clear statistical distinction can be made. On the other hand, reported overall QoE scores for intermediate players varies.

In the case of SS3, intermediate players had on average slightly higher scores than novice players, while in the case of HS we observed that their scores were slightly lower when compared with experienced players. It should be noted that the ratings in Figure 5.14 represent aggregate scores. When analyzed on a per test scenario basis (Figure 5.15), in the case of SS3 experienced players tended to give lower scores for lower quality scenarios, as opposed to novice players. This may be attributed to the hypothesis that novice players are generally less sensitive to different quality variations (this was also visible when considering the distributions of scores across all scenarios per skill level). For HS, no conclusive observations could be reported.

Furthermore, we compared the overall QoE scores of experienced players considered in this study with scores obtained in Study S3, which considered only experienced players. A comparison of scores is given in Figure 5.16, showing average QoE ratings for different frame rate conditions at a set bitrate of 10 Mbps. It should be pointed out that differences between methodologies (e.g., different tested frame rate levels) and context (single-player mode was

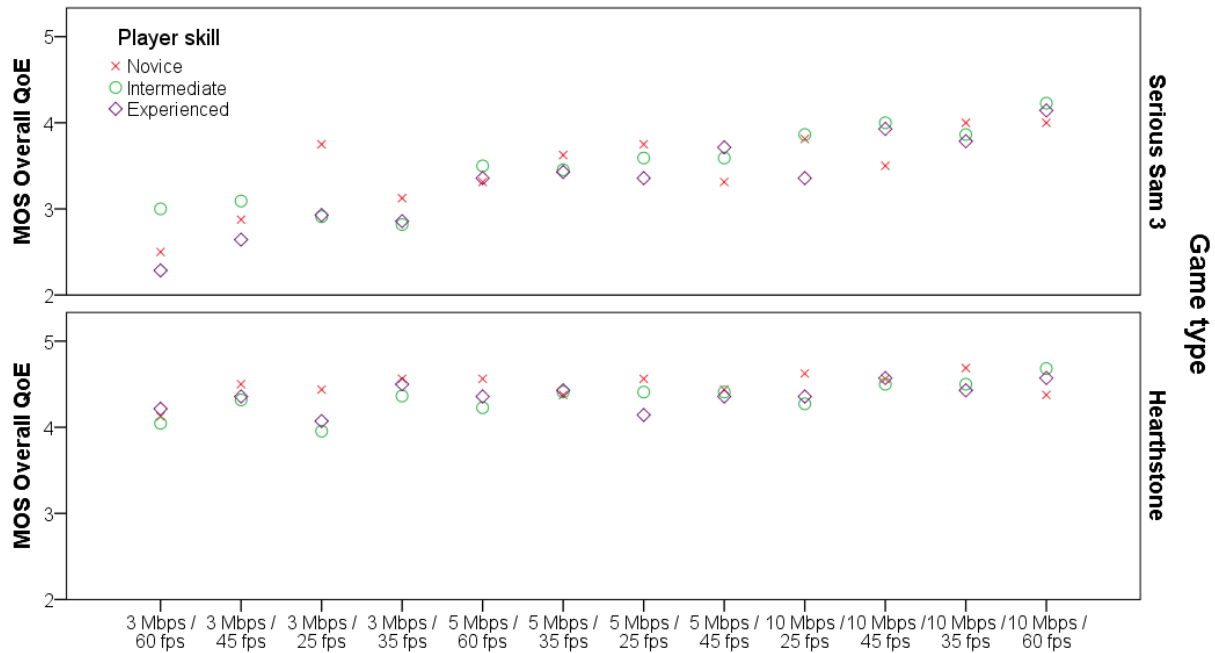

Figure 5.15: Mean ratings of overall QoE per skill level for different test scenario in Study S4 (scenarios arranged according to ascending mean QoE)

used in study S3 [14] while multiplayer mode was used in this study) could potentially impact the differences in the presented results. In Study S3, the range of tested frame rates was 15 – 30 fps, while in this study (Study S4) we tested 25 – 60 fps. Consequently, the “best” scenarios observed by players (in terms of frame rate) in Study S3 were 25 and 30 fps, while in Study S4 25 fps was the “worst” tested value. Interestingly, the same test condition (25 fps, 10 Mbps) was rated quite differently in these two studies, which can likely be attributed to the choice of tested stimuli and player tendency to compare conditions relative to one another. This raises several important questions regarding: use of rating scales and comparison of results, specifications of different contexts (i.e., single vs group play), and the implications of ranges of tested system parameters (in this case frame rate). We note that recent efforts have aimed at addressing the challenge of standardizing test methodologies for gaming QoE [111].

Referring again to the results of Study S4, the extent of the degradations introduced is illustrated in Figure 5.17. Three areas of degradations can be identified (as presented in [136] regarding generic relationships between QoE and QoS): (1) no distortion perceived, (2) user disturbed, and (3) user gives up. During this study and in the case of SS3, most of the player scores are located in the “user disturbed” area. For the case of HS, the tested degradations did not have a significant impact on perceived QoE, and thus player scores are portrayed in the “no distortion area”. It should be noted that Figure 5.17 is meant to only illustrate qualitative trends, and that future studies are needed to assign concrete values to points along the axis.

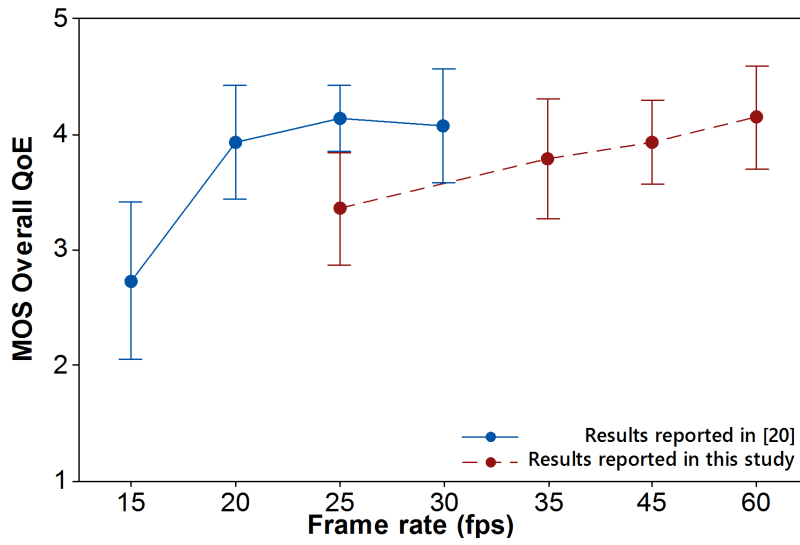

Figure 5.16: MOS scores for different frame rates at a fixed bitrate of 10 Mbps for SS3

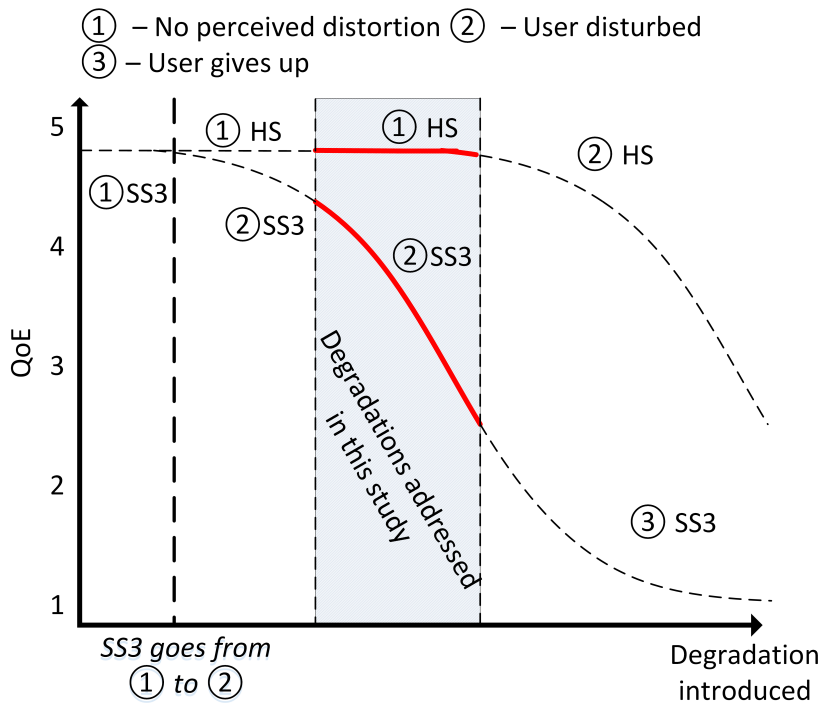

Figure 5.17: Impact of degradations on QoE for tested games in Study S4

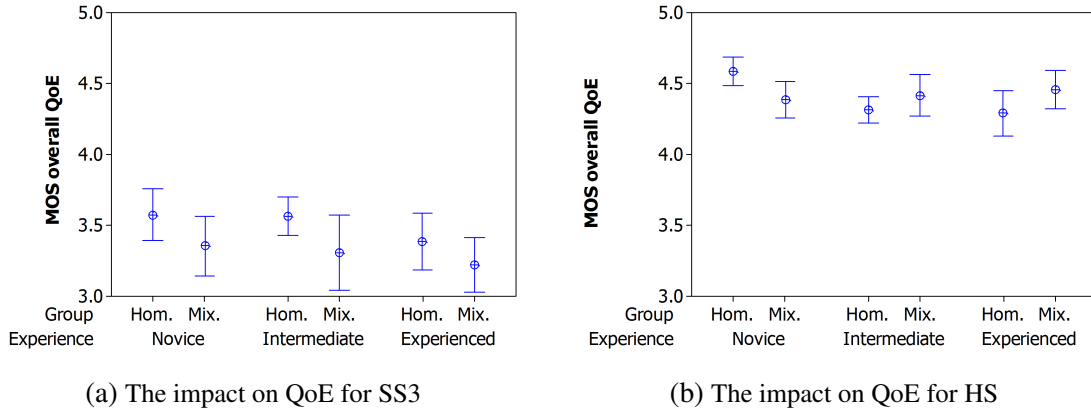

Figure 5.18: The impact of group composition on QoE for tested games in Study S4 (avg. values and 95% CI)

Context parameters

The impact of the players' social context on QoE was additionally inspected. Social context is represented by players' group composition based on previous player's gaming experience. Out of 13 groups that participated in our study, 2 of them were composed of only experienced players, 4 groups were composed of intermediate skilled players and 2 groups included only novice players. The remaining 5 groups were heterogeneous groups with regards to previous player's experience, and each of these mixed groups consisted of at least one novice and one experienced player. Figure 5.18a displays average scores of overall QoE for SS3 based on group composition. The distinction of QoE scores between homogeneous and mixed groups was minor across all experience levels, although a slight decrease of perceived QoE can be observed when playing in mixed groups for all levels. This differs from findings in [21], where only experienced players reported lower QoS scores in mixed groups, while for novice and intermediate player playing in mixed groups improved QoE, due to playing with experienced players which yielded better game performance results for less experienced players. However, group composition had a different impact on QoE for HS (Figure 5.18b). While novice players reported lower QoE scores in mixed groups, perceived QoE of intermediate and experienced players was slightly improved while playing in the same group composition. This can be attributed to the nature of the tested games. Whereas SS3 was played cooperatively in the study, HS is a game where two players play against each other and only one of the players wins. This sometimes results with imbalanced game sessions where novice and experienced players were paired against each other, and in these types of game situations more experienced players generally win with ease, making gaming sessions more enjoyable for winners, as also reported in [140]. However, these results are only indicative and the number of test subjects is rather low for each category leading to very broad and overlapping confidence intervals. Further testing of this parameter is needed for it to be quantified and incorporated into future QoE models.

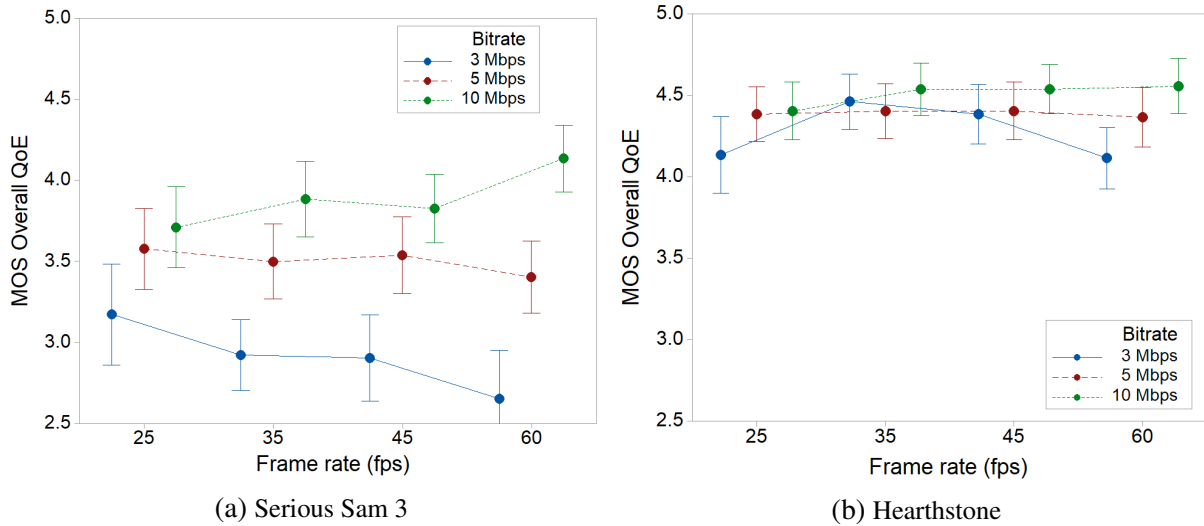

Figure 5.19: Impact of video parameters on overall MOS scores for SS3 and HS (Study S4)

System parameters

The impact of frame rate on subjective ratings of overall QoE under fixed bitrate for both games is shown in Figure 5.19. The graph shows more clearly what was stated previously with regards to the impact of video encoding parameters on perceived QoE for SS3: players noticed degradations of QoE due to reduced frame rate for high bitrate levels as a result of gameplay fluidity degradations. However, for low bitrate levels (especially 3 Mbps), a decrease of frame rate led to a significant increase of graphics quality, which impacted players more than degradations of gameplay fluidity. On the contrary, for HS, players perceived QoE impairments (induced by manipulations of video encoding parameters) to a far less extent, which once again led to the conclusion that different encoding configuration strategies can be employed for different types of games.

Additional QoE metrics beyond MOS

In addition to the QoE MOS values presented so far, another set of QoE metrics was computed based on the collected data: the percentages of users judging the gameplay scenario as Good or Better (GoB, referring to the ratio of users scoring 4 or 5 on a 5 pt. ACR scale) or Poor or Worse (PoW, referring to the ratio of users scoring 1 or 2 on a 5 pt. ACR scale), as well as acceptance measures and Standard deviation of Opinion Scores (SOS). Such QoE metrics can provide detailed insight into user satisfaction with the service [90, 91] and be exploited to prevent user churn [141].

Figure 5.20 plots the GoB ratio for all MOS scores (each point corresponds to a single test scenario), with lines portraying a curve fitting. For SS3 it can be seen that even for the test scenario with the highest MOS for overall QoE, the GoB ratio was not higher than 0.8, meaning

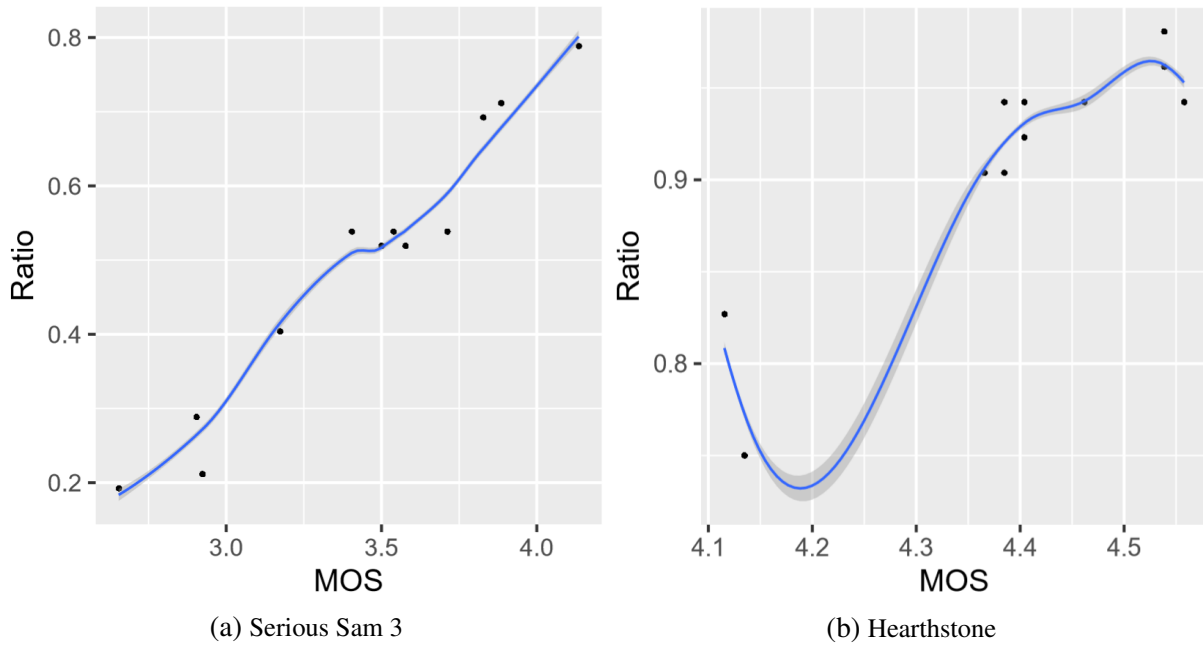

Figure 5.20: GoB ratio of scores for tested games in Study S4

that 20% of players rated that scenario with 3 or less. Furthermore, for a drop of only 0.5 in MOS scores (from 4.1 to 3.6), the ratio of players rating the service as good or better fell for 30%. When the GoB ratio is analyzed for HS, it can be observed that only a single test scenario resulted in a GoB ratio slightly lower than 0.8, confirming that users were highly satisfied with the service, regardless of the system degradations.

PoW ratio plotted against MOS scores for all test conditions is shown in Figure 5.21. For SS3, it can be observed that players were generally satisfied with half of the experiments, referring to those test scenarios where the PoW ratio was less than 0.1% (MOS was above 3.5). On the contrary, in the case of HS there were only two test scenarios that had a PoW ratio higher than 0, and even in those experiments, only a few players gave low QoE scores (scores 1 or 2). For all other test scenarios, players did not give scores of 2 or less, once again indicating that players did not perceive the quality impairments (imposed by reduced bitrate or frame rate) during the HS experiments.

The relationship between MOS and acceptability level (i.e., willingness of players to continue using the service under the given test conditions) can be seen in Figure 5.22. In the case of SS3, it can be noticed that only the test scenario with MOS of overall QoE higher than 4 had an acceptability rate more than 90%. This shows that for SS3, players were fully satisfied with the service only under unimpaired test conditions. For HS, all test scenarios, regardless of MOS, had an acceptance rate higher than 90%.

Another metric related to user score distributions was calculated, namely the Standard Deviation of Opinion Scores metric as proposed in [90]. SOS reflects the user diversity and its relation to the MOS by postulating a square relationship between the variance SOS and MOS

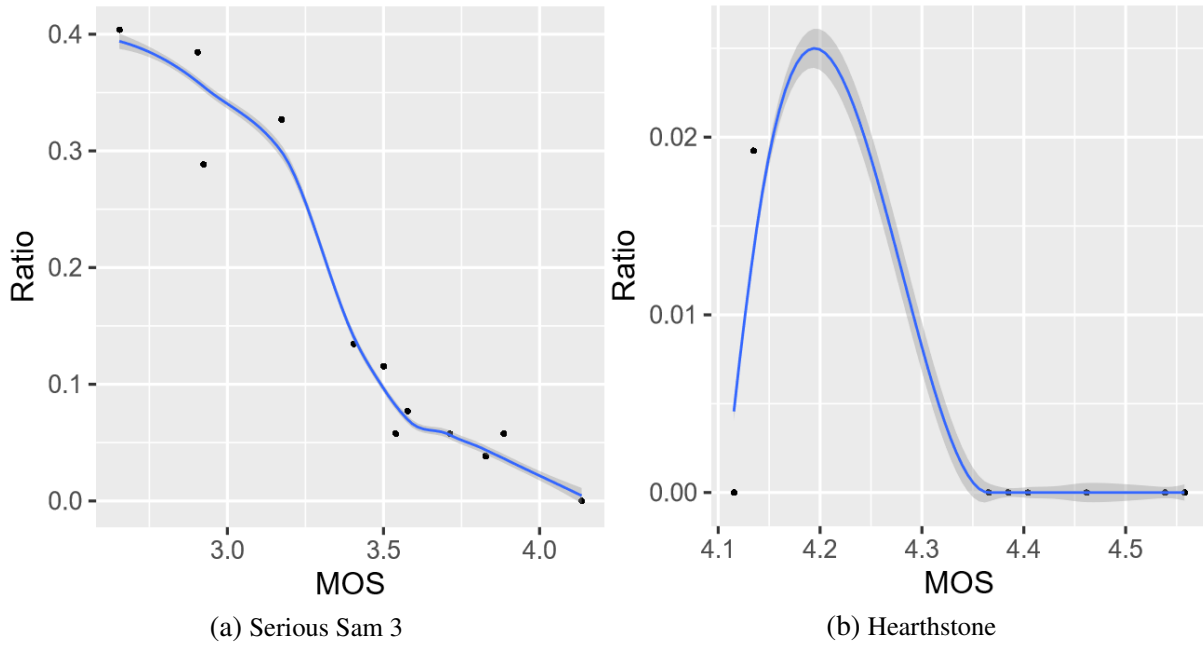

Figure 5.21: PoW scores for tested games in Study S4

parametrized by the SOS parameter a that can be modeled with the following equation (assuming ratings on a 5 pt. ACR scale):

$$SOS(x)^2 = a(-x^2 + 6x - 5), \quad (5.1)$$

where x represents MOS. One SOS parameter a was computed for each of the tested game in the study. As the value of the parameter a is lower, the less diverse the user ratings are for a given game, i.e., subjects are presumably more confident in their ratings. The values of SOS for both tested games were relatively small, as visible from Figure 5.23. The value of parameter a for HS was 0.1996, while for SS3 it was a bit higher at 0.2128. Compared to previous studies, obtained a values are lower than reported values for cloud gaming for different games (fast paced $a = 0.2718$, medium paced $a = 0.3287$, and slow paced games $a = 0.3466$), presented in [91] based on the QoE studies done in [22]. Consequently, it can be concluded that Study S4, reported in this section, had relatively low a values and that for such a dynamic activity as gaming this could be taken as acceptable user diversity.

5.2.3 QoE models derived from the data collected in Study S4

To model QoE as a function of video encoding parameters, we investigated different linear and non linear models to fit the data. It should be noted that the data is considered as interval data and not ordinal (i.e., the intervals between points on the rating scales are considered equal). Based on the collected data and by analyzing accuracy of fit for different models, we found quadratic models to provide the highest accuracy (which is in line with previous models proposed by

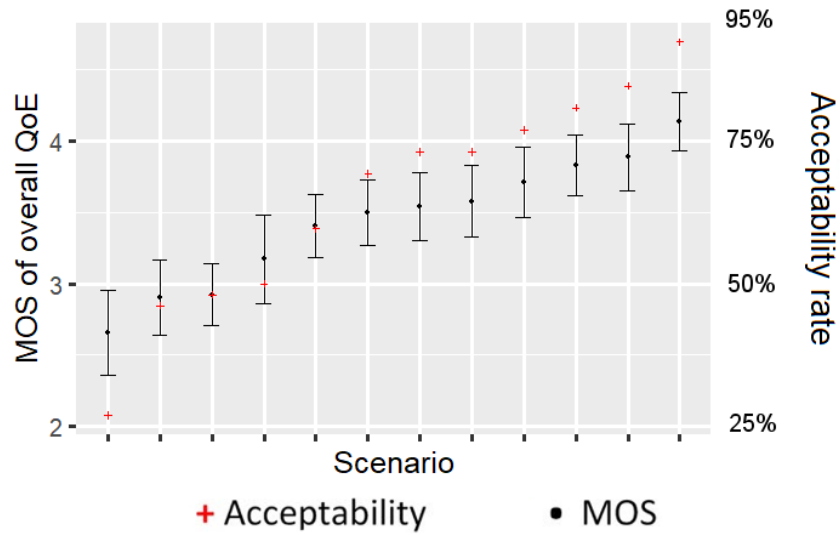

(a) Serious Sam 3

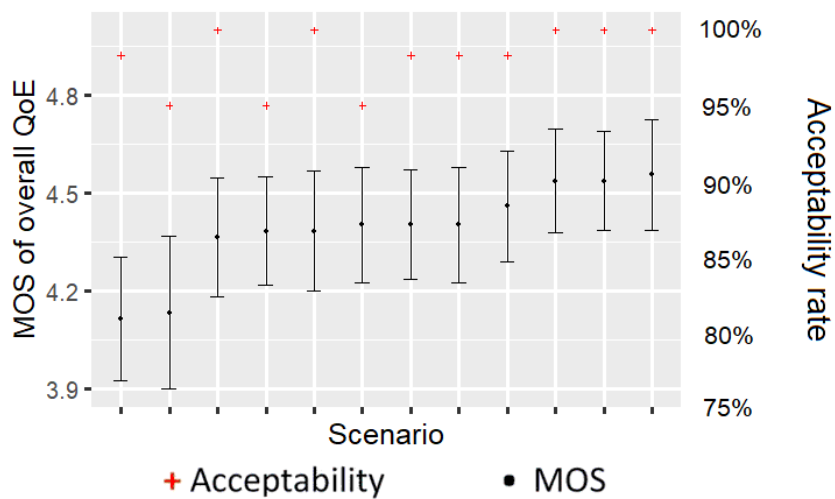

(b) Hearthstone

Figure 5.22: Acceptability ratios and MOS for QoE (with 95% CIs) per experiment for tested games in Study S4

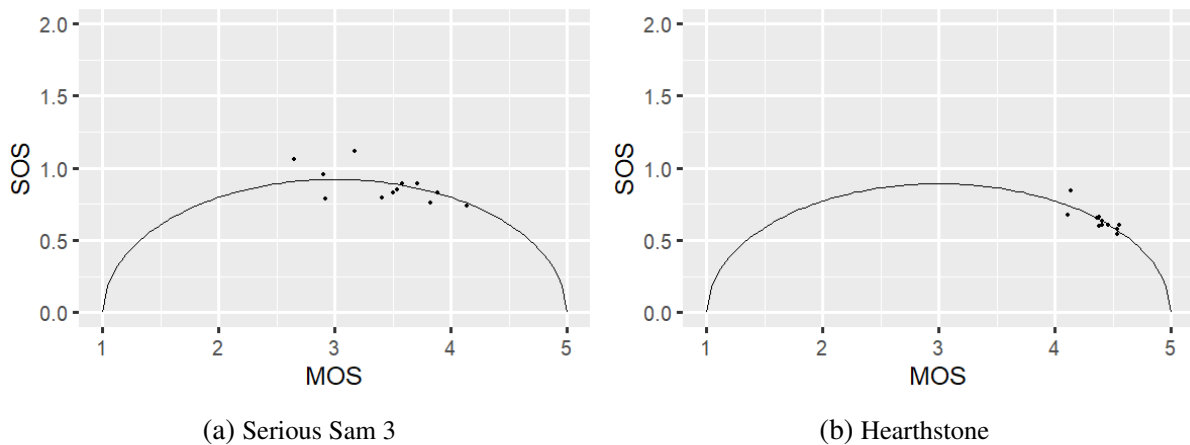

(a) Serious Sam 3

(b) Hearthstone

Figure 5.23: Distribution of Standard deviation of Opinion Scores (SOS) for tested games in Study S4

Table 5.3: The QoE models for tested games in Study S4

	Serious Sam 3				Hearthstone			
	All	Novice	Intermediate	Experienced	All	Novice	Intermediate	Experienced
frame rate, $\alpha_{g,1}$	2.84×10^{-2}	-9.63×10^{-2}	-9.25×10^{-3}	1.9×10^{-2}	3.4×10^{-2}	1.4×10^{-2}	3.89×10^{-2}	4.93×10^{-2}
bitrate (Mbps), $\alpha_{g,2}$	0.404	-2.19×10^{-2}	0.466	0.541	6.06×10^{-2}	7.23×10^{-2}	0.107	-2.52×10^{-2}
$I(\text{framerate}^2)$, $\alpha_{g,3}$	6.4×10^{-5}	6.14×10^{-4}	7.7×10^{-5}	-5.86×10^{-4}	-4.54×10^{-4}	-2.17×10^{-4}	-5.51×10^{-4}	-5.72×10^{-4}
$I(\text{bitrate}^2)$, $\alpha_{g,4}$	-3.13×10^{-2}	-2.19×10^{-2}	-2.84×10^{-2}	-4.64×10^{-2}	-4.81×10^{-3}	-3.35×10^{-3}	-1.02×10^{-2}	2.04×10^{-3}
frame rate:bitrate, $\alpha_{g,5}$	3.43×10^{-3}	4.73×10^{-3}	1.23×10^{-3}	5.4×10^{-3}	8.63×10^{-4}	-1.57×10^{-4}	1.74×10^{-3}	6.47×10^{-4}
Constant, $\alpha_{g,6}$	2.611	4.902	1.897	1.116	3.473	4.065	3.155	3.296
R^2	0.986	0.915	0.969	0.977	0.782	0.496	0.773	0.763

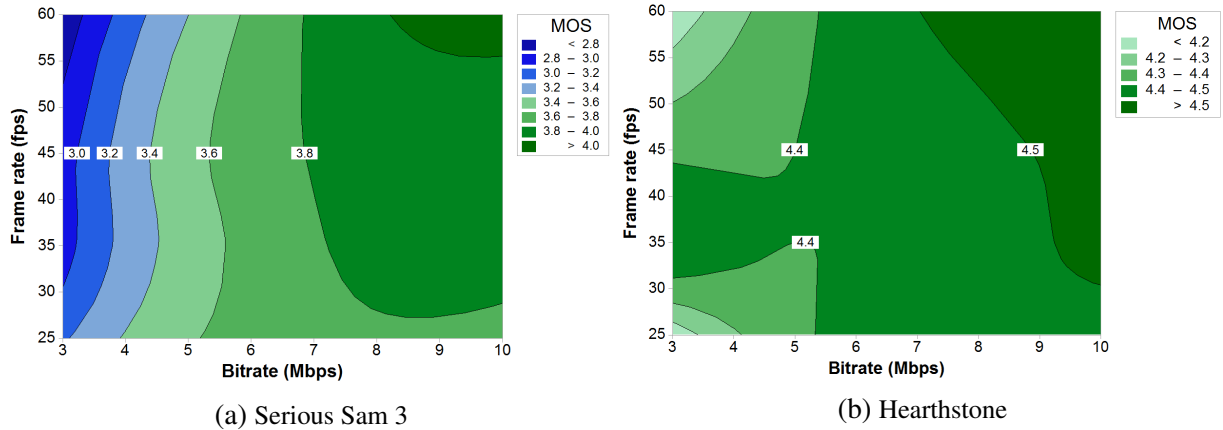
**Figure 5.24:** Illustrated QoE models for Serious Sam 3 and Hearthstone

Hong *et al.* [13]. We thus model MOS as a quadratic function of manipulated video encoding parameters as follows:

$$MOS(g, f, b) = \alpha_{g,1}f + \alpha_{g,2}b + \alpha_{g,3}f^2 + \alpha_{g,4}b^2 + \alpha_{g,5}fb + \alpha_{g,6}, \quad (5.2)$$

where $\alpha_{g,1} - \alpha_{g,6}$ are game-specific model parameters, b is video bitrate and f is video frame rate. The values of model parameters for tested games are summarized in Table 5.3, together with related R-squared values (the coefficient of determination indicating how well data fits a QoE model). For QoE models where all players, regardless of experience, are considered, it can be seen that the derived QoE model for SS3 (fast-paced game) has a better fit considering collected data ($R^2 = 0.986$) than the QoE model for HS ($R^2 = 0.782$). These QoE models are visualized in Figure 5.24, whereby the QoE model for SS3 is visually similar to the QoE model for Call of Duty reported in [13].

In addition to modeling QoE as a function of bitrate and frame rate, players' experience was also investigated, resulting with QoE modeling separately for different player experience levels. Obtained models are illustrated in Figure 5.25. As previously stated, experienced players are expected to be more aware of game impairments due to QoS degradations, and in previous studies have been shown to rate perceived QoE with lower scores than novice players. In case of SS3, novice players' QoE scores were not consistent with video quality deteriorations through test scenarios, e.g., for fixed 10 Mbps bitrate their perceived QoE was higher at lower frame rates, which conflicted with QoE scores from other skill groups.

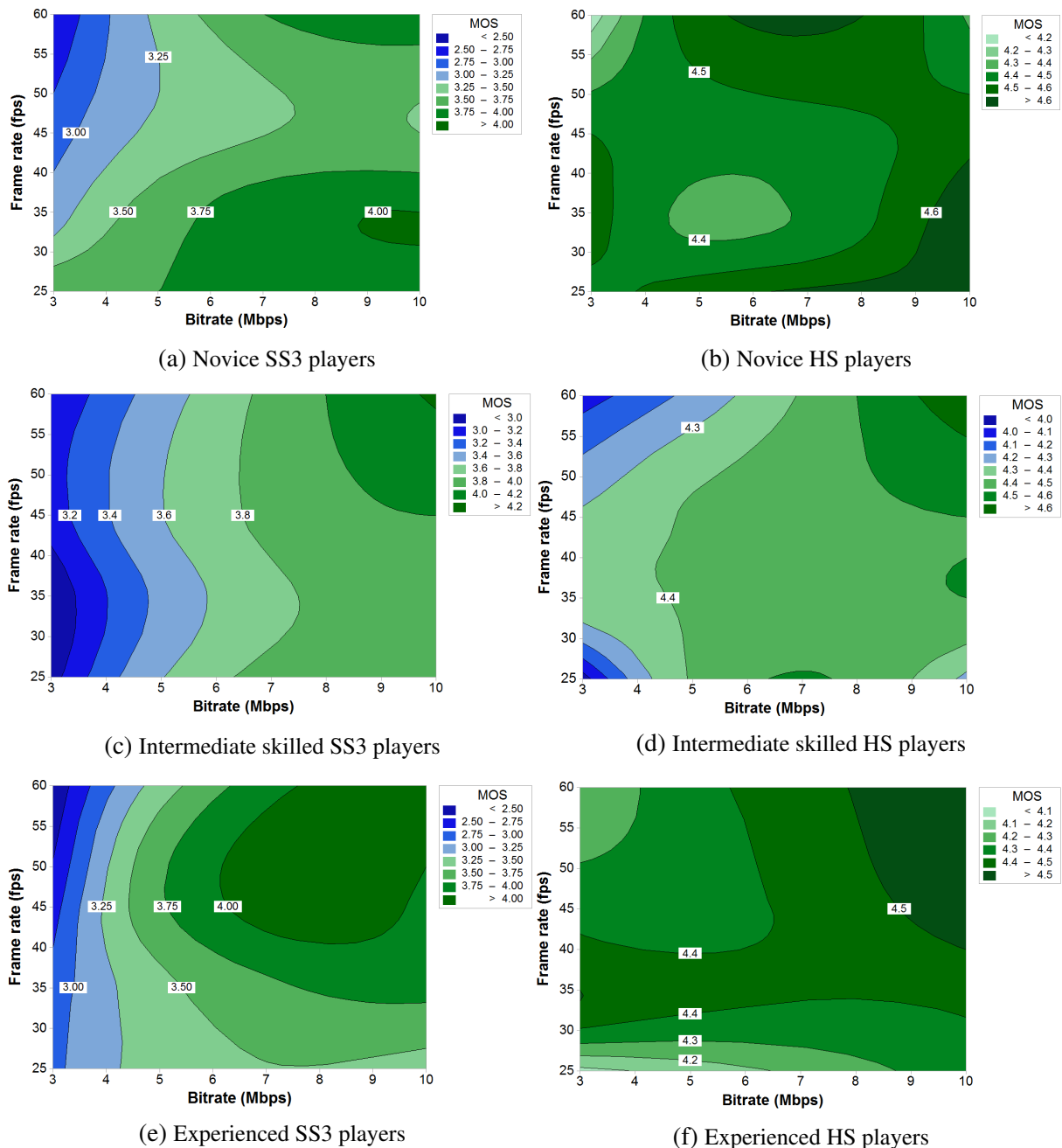

Figure 5.25: Graphical representation of QoE models for Serious Sam 3 and Hearthstone depending on player skill

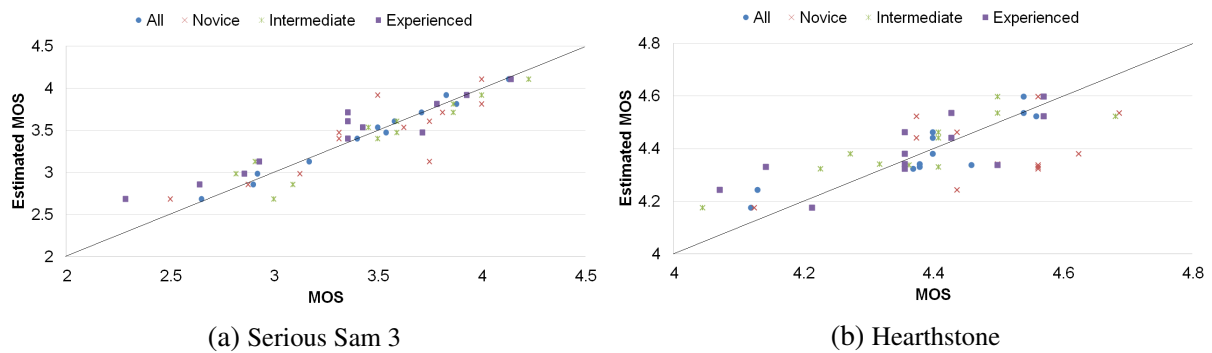

Figure 5.26: Accuracy of estimated QoE ratings vs subjective QoE ratings for tested games in Study S4

Figures 5.26a and 5.26b show the accuracy of the acquired prediction models (considering all player types) for QoE for SS3 and HS. If the QoE model designed without considering player experience is used to estimate overall QoE for different skilled players, it can be observed that there are wide discrepancies between estimated and reported values of QoE, resulting in lower QoE estimation accuracy. This possibly indicates that player skill may be used as one of the inputs for QoE modeling.

Based on the presented results in the section, **the following key findings** can be highlighted for Study S4:

- The results indicate that there is no linear relationship between frame rate and QoE – in some cases it is better to deliver lower frame rate and increase graphics quality. This is contrary to the results reported in Study S3, indicating a need to further investigate the impact of different video encoding parameters on other games,
- The game type clearly needs to be taken into account when evaluating the QoE for cloud gaming, as derived QoE models for tested games were significantly different,
- The results have shown that there is significant impact of players' previous gaming experience, which is thus incorporated in our models, while we concluded that for social context more research is needed to be able to numerically quantify its impact.

5.3 Studies S5 and S6 - Are there cases when the same video encoding adaptation strategy should be employed for games belonging to different genres?

Studies S5 and S6 expanded upon the results reported in Study S4 by investigating the impact of video encoding parameters on players' QoE for new games in order to address research question **RQ3**: “Can the same video encoding parameters (in terms of bitrate and frame rate), derived

so as to maximize QoE in light of bandwidth constraints, be assigned to games belonging to different genres (according to existing game categorizations)”. This would indicate that the choice of which video adaptation strategy to apply would not necessarily be based solely on which genre a game belongs to (e.g., first person shooters, racing games, real time strategies), but rather that other parameters should be considered (e.g., such as those related to temporal and spatial characteristics of the video stream). Study S5 investigated the impact of video encoding parameters for a new, fast-paced game (belonging to a different genre as compared to previously tested games), while in Study S6 a new slow-paced games from different genre was tested to investigate the same research question.

5.3.1 Methodology in Study S5

A subjective study involving 28 participants and two games was conducted to investigate the impact of bitrate and frame rate on perceived QoE. Similarly to Study S4, the collected data was analyzed to investigate the influence of user and system factors on QoE, and to subsequently derive QoE estimation models for tested games.

The methodology used in Study S5 is very much like the methodology used in Study S4 (described in Section 5.2.1), thus in this section we only highlight the differences between the methodologies. Both studies consisted of participants taking part in a two and a half hour long gaming session that was conducted in the previously described laboratory environment shown in Figure 5.8.

With regards to the diversity of the tested games, the aim was to test games belonging to different genres so as to determine whether or not different video encoding adaptation strategies should be applied across different types of games. As a result, two games were played in Study S5: the previously tested game *Serious Sam 3*, representing a fast paced first person shooter game, and *Orcs Must Die! Unchained (OMD)*, a third person hybrid action tower defense game. Both games can be described as fast-paced games, but however belong to different genres, as detailed below.

The differences between the tested games are illustrated in Figure 5.27 and according to the previously described categorization given in Section 5.2.1. With regards to the number of players and input rate, SS3 and OMD are placed in the same category. Further, in the dimension of gameplay pace, SS3 is placed in category 5 as the rate of events (i.e., attackers in the game) can be even multiple in one second, whereas OMD is plotted in the middle as the pace changes over time (ranging from a slow paced placing of defenses to highly paced battles with waves of enemies). Lastly, the camera perspective dimension is different for the tested games, as SS3 is a first-person shooter, and OMD a third person game. HS and SS3 were selected in Study S4 as they represent two ends of the spectrum on many of the defined dimensions, resulting with selection of two completely different games in every considered gameplay aspect. For Study

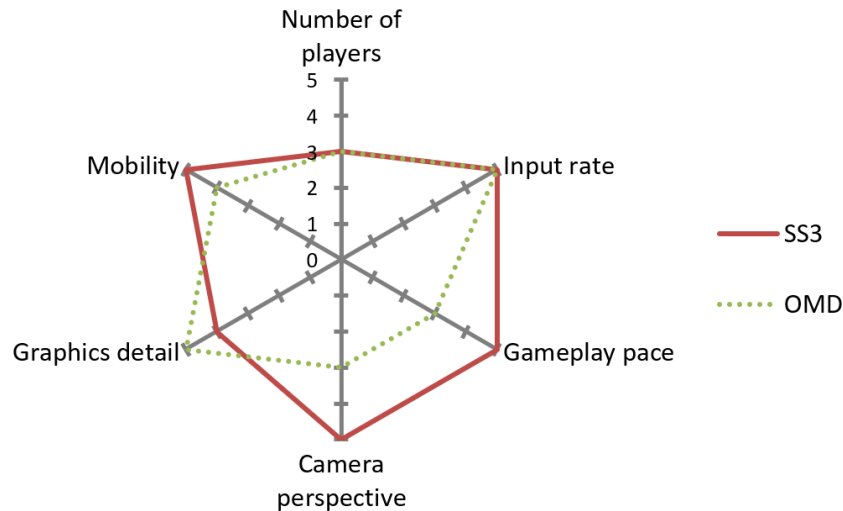

Figure 5.27: Comparison of game characteristics for tested games in Study S5

S5, OMD was thus selected from a different game genre as compared to SS3, but is similar in some of the dimensions to SS3, resulting with the tested games being appropriate to test our initial hypothesis. Both games were played in HD-ready resolution (720p) with default graphics settings.

The participants in Study S5 were 28 students enrolled at the University of Zagreb: 21 male and 7 female, aged between 22 and 33 (median age 23). Similarly to Study S4, the participants were instructed prior to the study to fill in an online questionnaire, so as to obtain relevant information about their previous overall gaming experience and gaming experience relevant to the tested games. As a result, 8 novice, 9 intermediate skilled and 11 self-reported experienced players took part in Study S5, making the participants in Study S5 on average more experienced than the participants in Study S4. Due to a smaller sample size compared to Study S4, the participants were only organized in heterogeneous groups: each of the formed heterogeneous groups had one novice and one experienced player, resulting with 7 groups with 4 players in each group.

With regards to manipulated system parameters, the same exact video encoding parameters (bitrate, frame rate) on identical levels as in Study S4 were tested: frame rate values of 25 fps, 35 fps, 45 fps and 60 fps, while bitrate values were limited to 3 Mbps, 5 Mbps, and 10 Mbps. Considering manipulated video encoding parameters and different games, a total of **24 different test conditions** were investigated in Study S5, with all conditions tested by each test group. It should be noted that the reference testing conditions were different between Study S4 and Study S5. In Study S4, the participants played a tutorial phase on the cloud gaming servers, thus experiencing unimpaired gameplay by the cloud set-up. On the other hand, the participants in Study S5 initially played games under the best test conditions on cloud gaming clients (training phase).

Regardless of the previously described difference in the methodology between the studies, in both studies the first 12 test scenarios involved playing one round of SS3 cooperative survival mode on a single map. During these test scenarios, participants cooperated with each other to survive longer on the map. The second half of the experiment involved playing OMD, unlike in Study S4, where HS was played. The group composition and gameplay (cooperation between players) remained the same in the case of OMD.

5.3.2 Results from Study S5

As two separate studies, but essentially very similar user studies were conducted, the possibility of combining results for SS3 was considered to estimate a combined effect across two studies. For that purpose, it was essential to check if the effects found in the individual studies are similar enough to join the data and analyze the combined effect. Therefore, the homogeneity of variance of the data was tested using Levene's test. Results have shown that SS3 group variances cannot be treated as equal ($F = 27.32, p < 0.05$). The most likely explanation for the difference between SS3 QoE ratings in both studies lies within the design of the user studies. From the methodological perspective, the only difference between conducted user studies was in the training phase: in Study S4, participants played a tutorial phase on the cloud gaming servers, thus experiencing unimpaired gameplay by the cloud set-up. On the other hand, the participants in Study S5 initially played games under the best test conditions on cloud gaming clients. Such a difference in terms of methodology might explain why the subjective QoE ratings for SS3 are lower in Study S4 than in Study S5. Another additional explanation for the phenomenon could be the social factor: two different groups of players participated in the studies and the social dynamics between them might affect perceived gaming quality. Consequently, scores for SS3 were analyzed separately across the two studies.

The average subjective ratings of overall QoE for tested games in Study S5 are shown in Figure 5.28. Contrary to the results from Study S4, there was no statistically significant difference between QoE scores for SS3 and OMD, as determined by one-way ANOVA ($F = 2.282, p = .131$): it can be observed that QoE scores for both games have very similar values across the same test conditions. Furthermore, for both tested games, it can be noticed that manipulation of video encoding parameters could be utilized for achieving higher QoE levels under low network bandwidth availability. That is particularly visible for the test conditions with 3 Mbps bitrate, where it is clearly beneficial to lower the frame rate of a game stream to achieve better QoE scores. This reinforces the claim that in the case of poor network conditions, participants prefer graphics quality increase at the cost of gameplay fluidity.

Comparing with the results from Study S4, QoE scores for SS3 are on average higher in Study S5. For example, there are only 2 test scenarios in Study S5 that have average QoE scores lower than 3.5, while in Study S4 approximately half of the test scenarios are evaluated with

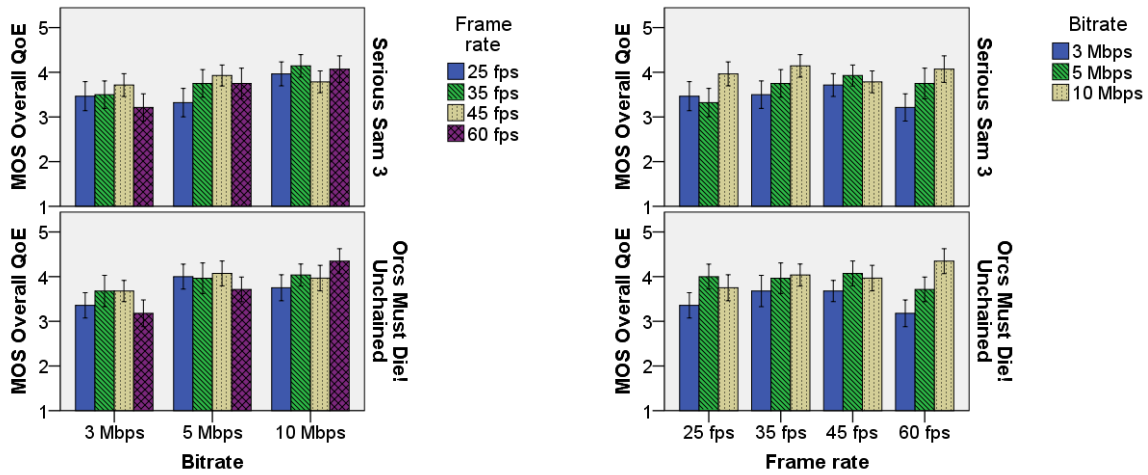

Figure 5.28: Subjective ratings of overall QoE (95% CI) in Study S5

such a low average score. These results could most likely be explained by the aforementioned difference in the reference testing conditions between the studies, resulting with higher QoE scores for SS3 in Study S5.

Besides collecting data about overall QoE scores, data about user perceived fluidity and graphics quality was also collected, analogously to Study S4. A heatmap overview of collected data (Figure 5.29) shows the mean scores for overall QoE, graphics quality, and fluidity for tested games in Study S5. Similarly to Study S4, a high correlation between the measured metrics can be observed. Spearman's rank-order correlation was computed to determine the relationship between overall QoE and measured QoE dimensions. Similarly to Study S4, the relationship between measured scores were nearly identical: overall QoE and fluidity had a strong, positive correlation ($r_s = .739, p < .001$), as well overall QoE and graphics quality ($r_s = .771, p < .001$). Unlike Study S4, where HS was scored on average much higher than SS3, and QoE scores for HS did not drastically change while manipulating video encoding parameters, QoE scores for OMD are similar to and vary in the same manner as SS3 scores.

As in Study S4, user willingness to continue playing is reported for each of the test scenarios, and is shown in Figure 5.30. In the case of Study S5, we noticed a similar pattern of players not willing to keep playing for both tested games: the percentage of players unwilling to continue playing for SS3 changes across different test scenarios, as was also the case for OMD in Study S4. At a bitrate of 10 Mbps, reducing frame rate resulted in an increase in the percentage of players not willing to continue, while at a bitrate of 3 Mbps the equivalent change of frame rate led to a higher percentage of players that are willing to continue playing. As in Study S4, the test scenario with 3 Mbps and 60 fps was the “worst” rated test scenario with more than a third of the players willing to quit playing for both tested games: 39.3% of players in the case of SS3 and 42.9% of players for OMD. This further confirms that the same video encoding strategy could be employed for games belonging to different genres, when aiming to optimize end user

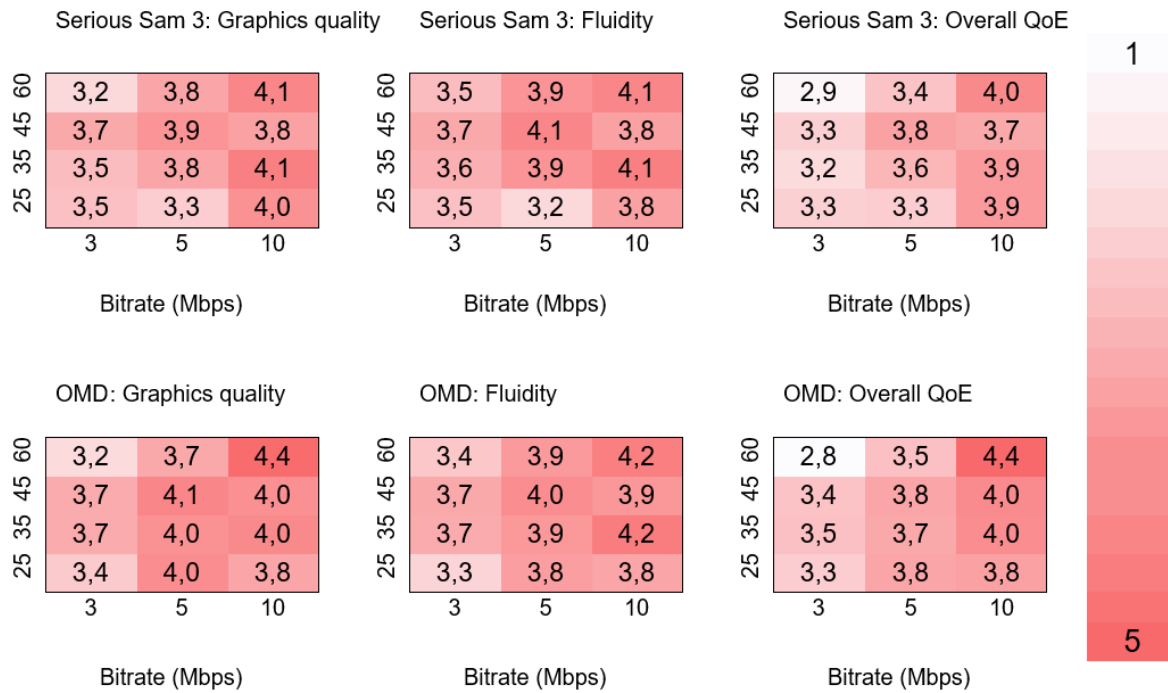

Figure 5.29: Aggregated subjective ratings for each game under different video configurations

QoE and reduce player abandonment of the service.

User parameters

As in Study S4, the impact of user parameters on QoE (primarily player’s previous gaming experience) was investigated. Overall QoE ratings for SS3 and OMD grouped by player experience are shown in Figure 5.31. Unlike Study S4, no clear trends are visible from the graph, i.e., the confidence intervals are overlapping amongst both experience and game categories, so no clear statistical distinction can be made.

As the ratings in Figure 5.31 represent aggregate scores, a per test scenario analysis was performed for both tested games (Figure 5.32). In the majority of scenarios, novice players gave higher scores for both games compared to intermediate and experienced players, further supporting the claim that novice players are less aware of imposed degradations in the system.

System parameters

Due to group composition (heterogeneous groups consisting of variously skilled players), the impact of context factors on player’s QoE was not investigated in Study S5. The impact of frame rate on subjective ratings of overall QoE under fixed bitrate for both games is shown in Figure 5.33. An identical pattern can be observed under 60 fps settings for both games, i.e., an increase in frame rate led to different perceived QoE depending on the current bitrate level. For 3 Mbps, severe decrease in QoE scores can be noticed due to the drop in graphics quality in

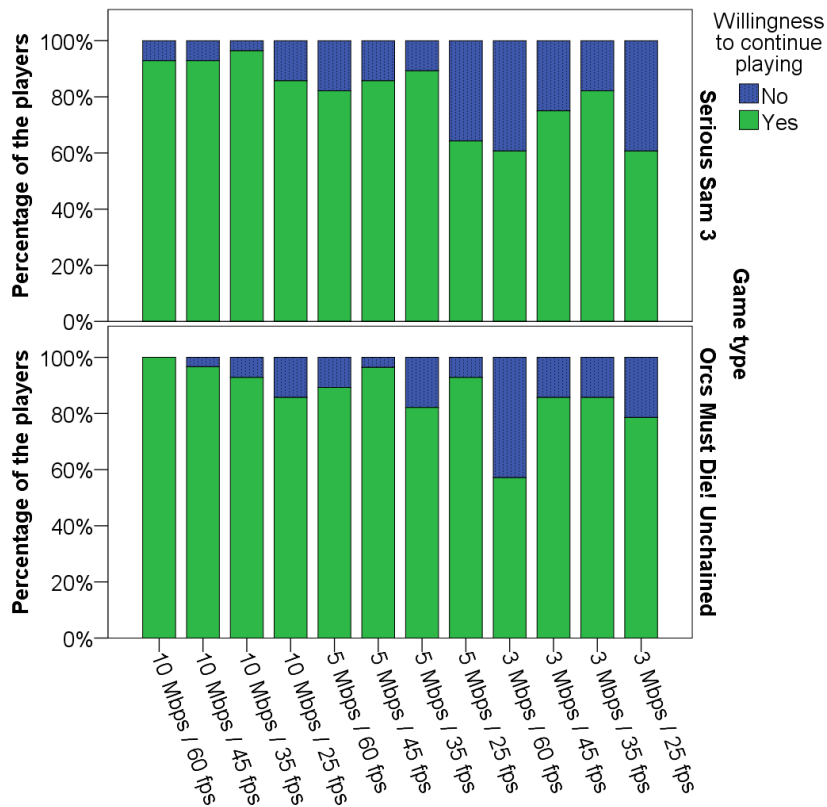

Figure 5.30: Willingness to continue playing under different test conditions for both tested games

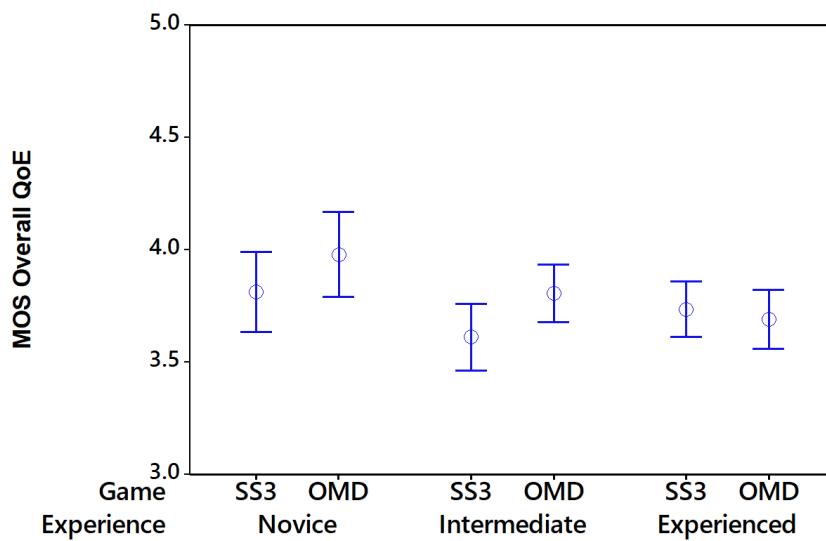

Figure 5.31: Subjective ratings of overall QoE (95% CI) for SS3 and OMD grouped by skill

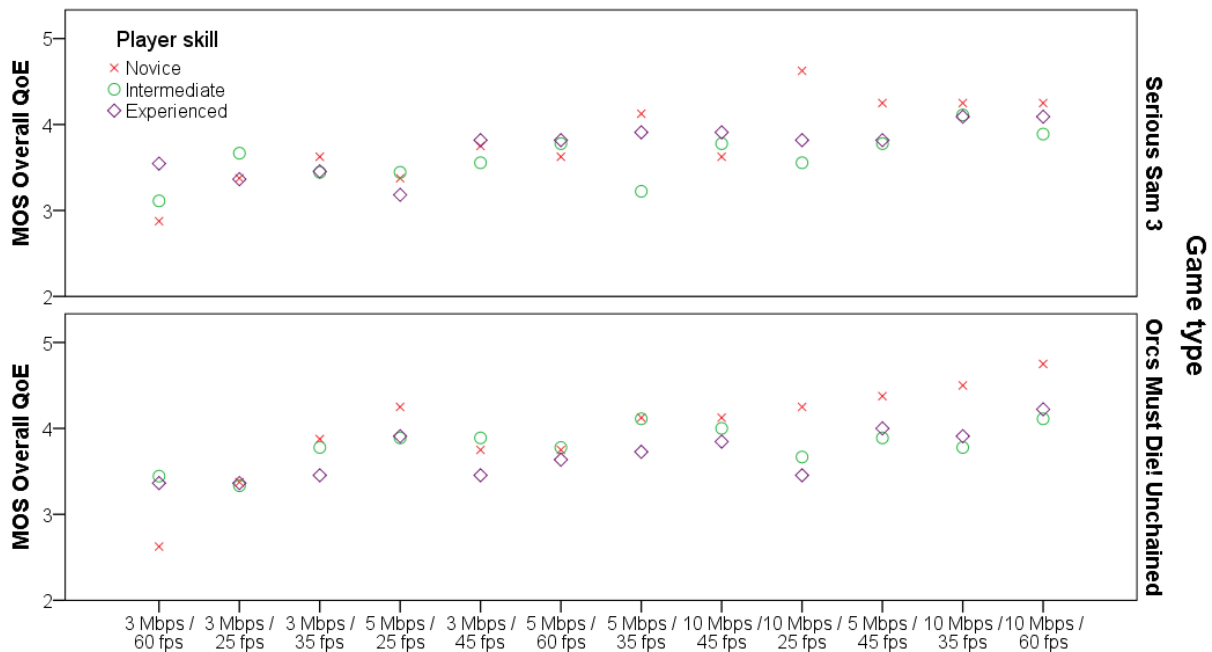

Figure 5.32: Mean ratings of overall QoE per skill level for different test scenario (scenarios arranged according to ascending mean QoE) for Study S5

these scenarios. On the contrary, with 10 Mbps the system had enough bitrate to accommodate increased information due to higher frame rate, resulting with a gain in QoE. As players for both tested games exhibited similar patterns in scoring QoE, we once again draw the conclusion that the same codec configuration strategy may be applied to games belonging to different genres.

Additional QoE metrics beyond MOS

We again compute QoE metrics based on the collected data: GoB, PoW, acceptance measures, and SOS. Figure 5.34 plots the GoB ratio for all test scenarios. For SS3, it can be observed that the GoB ratio drops from 0.8 to 0.55 if MOS is lowered by only 0.5 (from 4.0 to 3.5). When the GoB ratio is analyzed for OMD, it can be noticed that players were generally more satisfied with the service compared to SS3 experiments, with only 2 test scenarios having GoB ratio lower than 0.6. Also, in the middle of the plot for OMD, a negative slope can be observed: a few test scenarios had higher MOS and lower GoB ratio compared to adjacent test scenarios (based on MOS scores) which confirms that MOS should not be the only metric for evaluating user satisfaction with the service.

PoW ratio for all test conditions is shown in Figure 5.35. For both tested games it can be noticed that only one third of the test scenarios had a PoW ratio higher than 0.1. However, similar to the GoB ratio, a positive slope can be observed in the graphs for both games. For example, in the case of OMD, the test scenario with a MOS score slightly lower than 4.0 had one of the worst PoW ratios from all test scenarios. This can prove useful in the process of evaluating test scenarios (to be later utilized in service adaptation) with similar or identical

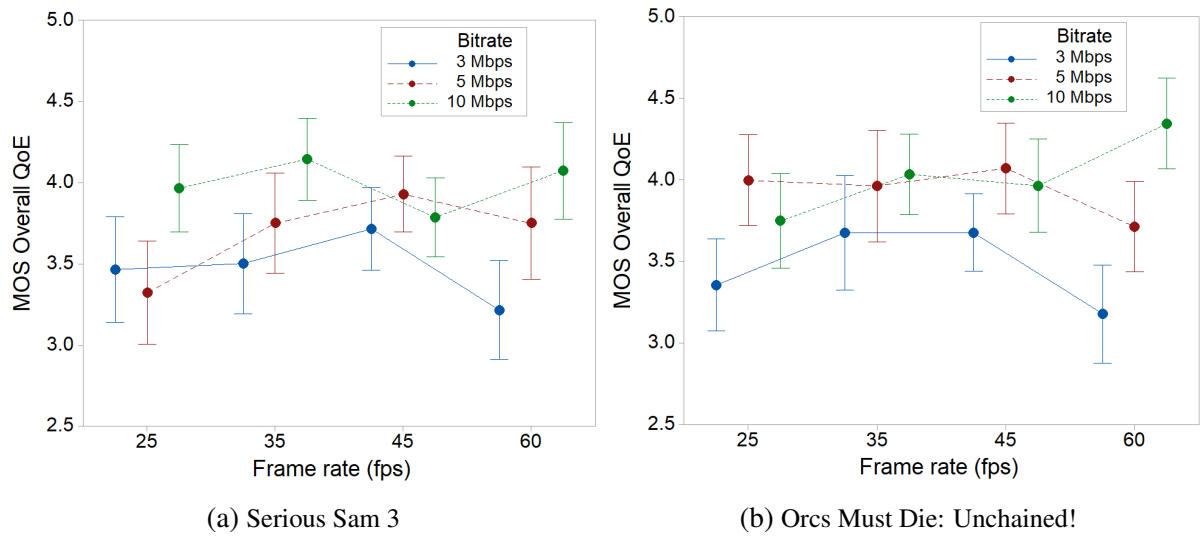

Figure 5.33: Impact of video parameters on overall MOS scores for tested games in Study S5

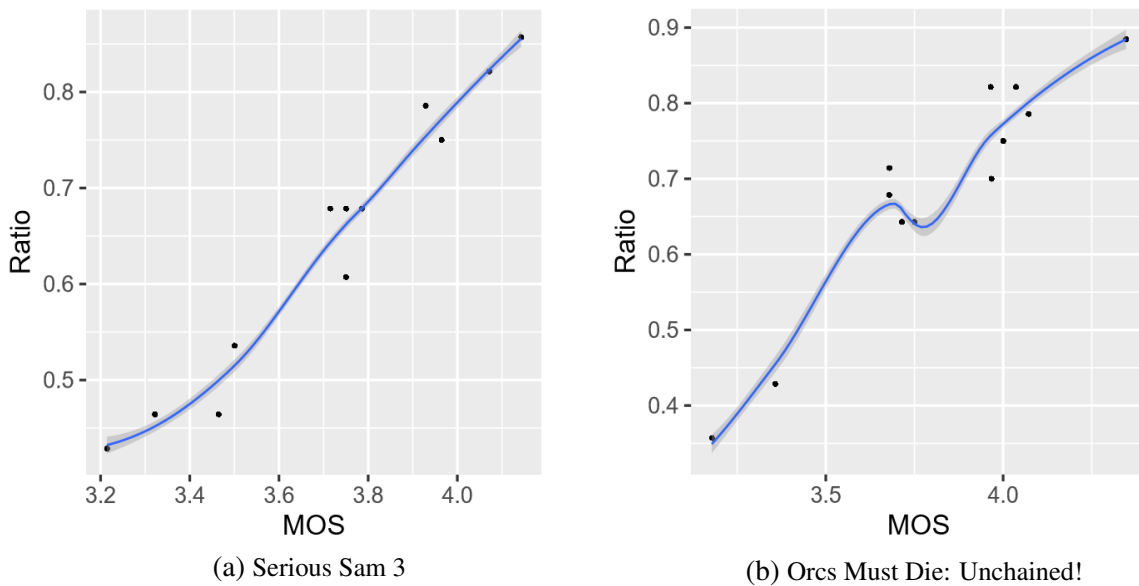

Figure 5.34: GoB scores for tested games in Study S5

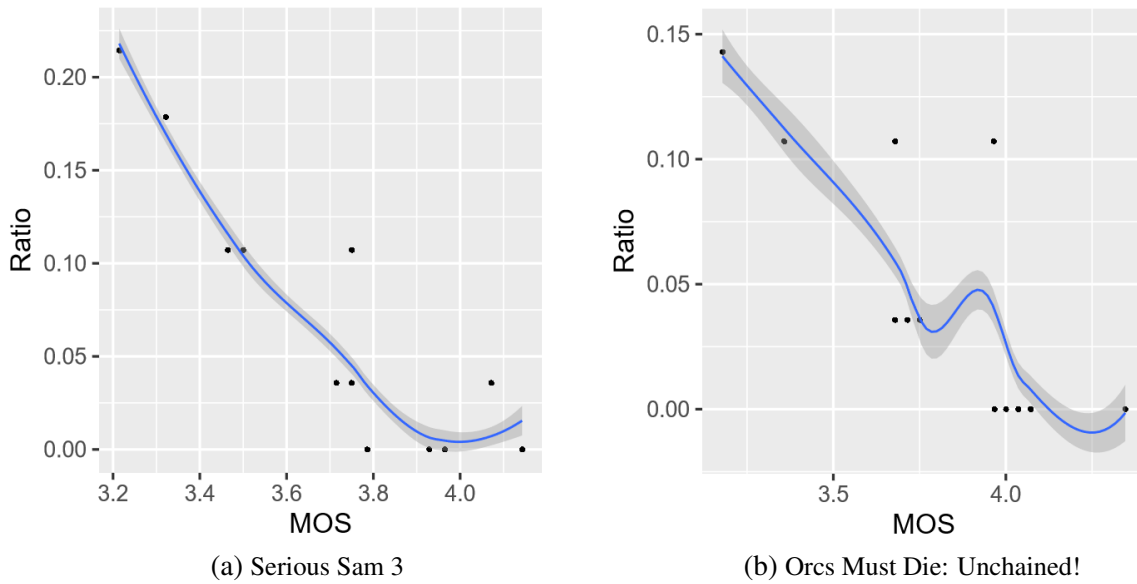

Figure 5.35: PoW scores for tested games in Study S5

MOS scores.

The relationship between MOS and acceptability level can be seen in Figure 5.36. Test scenarios with MOS of overall QoE 4 or higher had an acceptability rate more than 90% for both games. Lowering MOS from 4 by a value of 0.5 resulted with a drastic drop of the acceptability rate for SS3, while for OMD a less drastic decline occurred.

As related to user score distributions, the SOS metric was calculated. The SOS parameter a was computed for each of the tested games. The values of SOS for both tested games were relatively small, as visible from Figure 5.37. The value of parameter a was nearly identical for OMD (0.1689) and SS3 (0.163), which suggests that players were more confident during scoring compared to the participants in Study S4.

5.3.3 QoE models derived from the data collected in Study S5

Similar to Study S4, the impact of different game types and video encoding parameters on player's QoE was investigated in Study S5. A similar analysis was conducted to find the most appropriate QoE estimation model for collected data, as in Study S4. Results showed that the same quadratic function of bitrate and frame rate derived in Study S4 (Equation 5.2) was the most accurate form for describing gathered data.

As the results have shown previously for tested games in Study S5, gaming experience did not have any significant impact on player's QoE. Therefore, that user parameter was omitted from the analysis. The values of model parameters for tested games are summarized in Table 5.4. It can be observed that the derived QoE model for OMD has a better fit ($R^2 = 0.867$) than the QoE model for SS3 ($R^2 = 0.684$). Moreover, the proposed QoE model for SS3 from Study S4 achieves better fit to the data compared to the newly derived QoE model for SS3 in Study

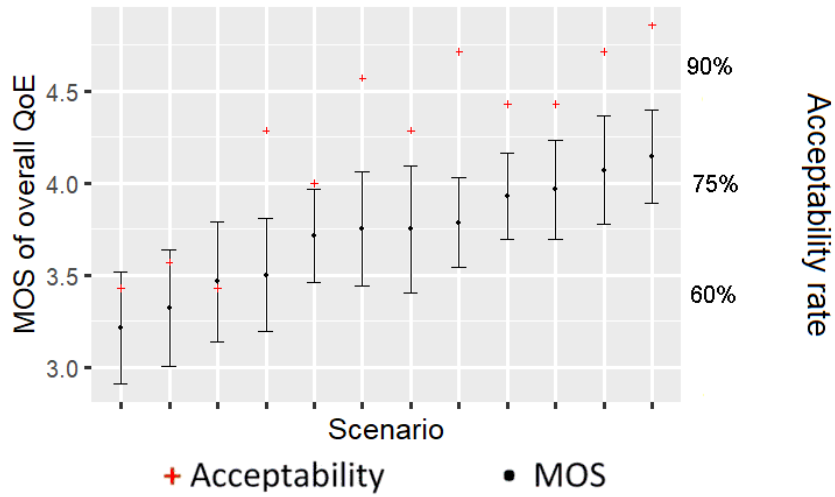

(a) Serious Sam 3

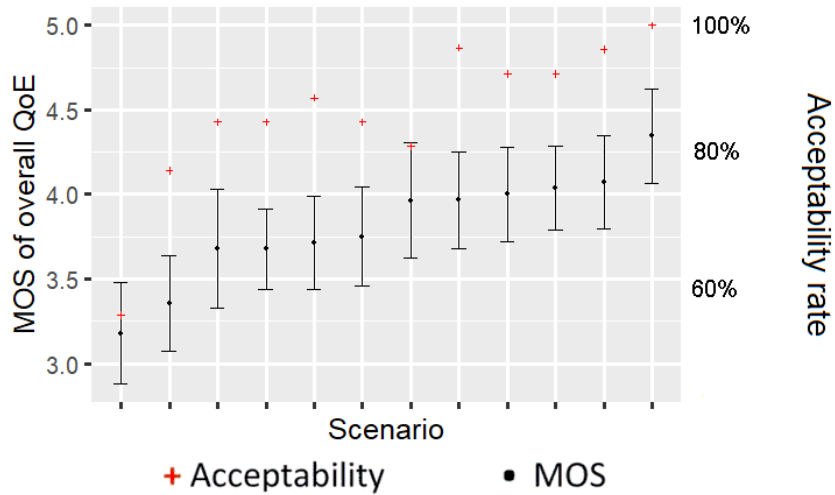

(b) Orcs Must Die: Unchained!

Figure 5.36: Acceptability ratios and MOS for QoE (with 95% CIs) per experiment for tested games in Study S5

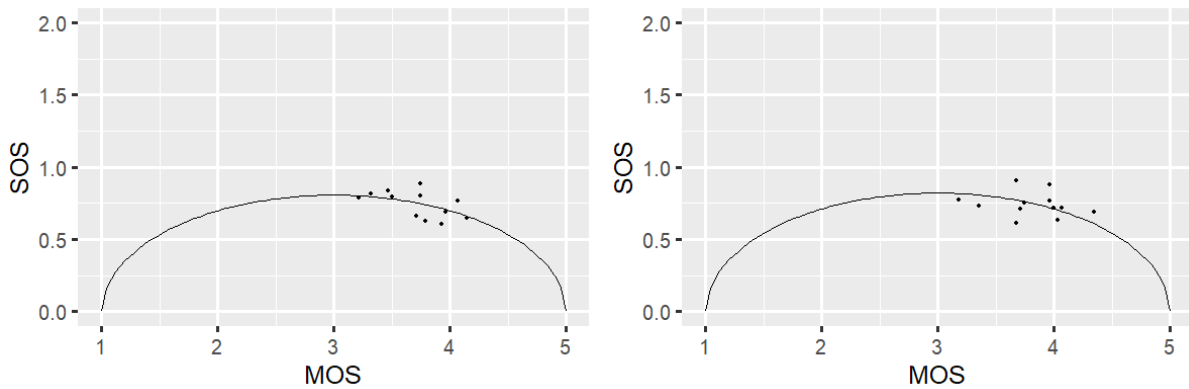

(a) Serious Sam 3

(b) Orcs Must Die: Unchained!

Figure 5.37: Distribution of Standard deviation of Opinion Scores (SOS) for tested games in Study S5

Table 5.4: The QoE models for tested games in Study S5

	Serious Sam 3	Orcs Must Die: Unchained!
frame rate, $\alpha_{g,1}$	$5.45 * 10^{-2}$	$3.48 * 10^{-2}$
bitrate (Mbps), $\alpha_{g,2}$	0.148	0.34
$I(\text{frame rate}^2)$, $\alpha_{g,3}$	$-6.35 * 10^{-4}$	$-6.31 * 10^{-4}$
$I(\text{bitrate}^2)$, $\alpha_{g,4}$	$-6.63 * 10^{-3}$	$-3.09 * 10^{-2}$
frame rate:bitrate, $\alpha_{g,5}$	$2.98 * 10^{-4}$	$3,28 * 10^{-3}$
Constant, $\alpha_{g,6}$	1.99	2.058
R^2	0.684	0.864

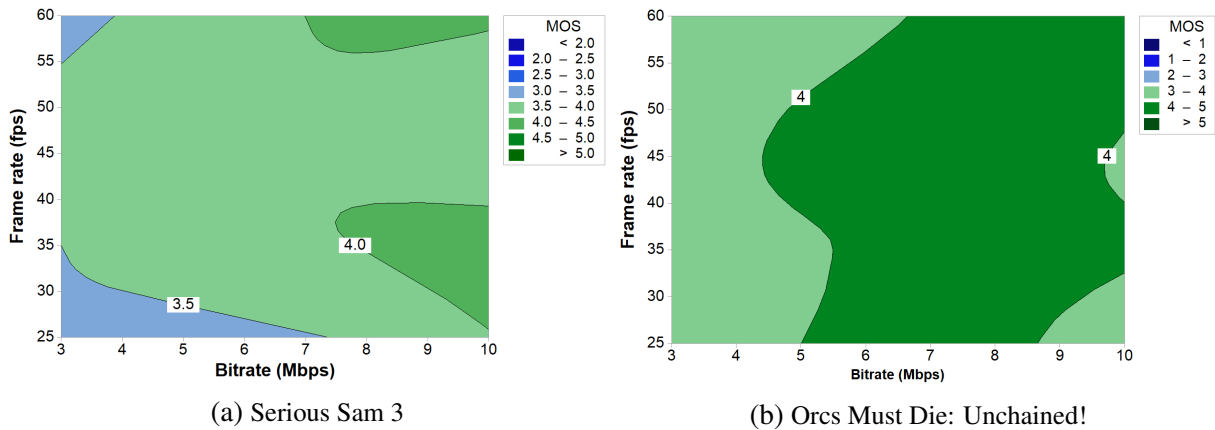
**Figure 5.38:** Illustrated QoE models for Serious Sam 3 and Orcs Must Die: Unchained!

S5.

Derived QoE models are visualized in Figure 5.38.

5.3.4 Methodology in Study S6

To verify the findings reported in Studies S4 [15] and S5 [35], we performed an additional subjective study to investigate the impact of bitrate and frame rate on players' QoE. Study S6 involved 39 participants and two distinct games. As in the previous subjective studies, subjective scores were gathered and analyzed to investigate if the previous conclusions can apply for games belonging to different genres.

Once again, the methodology used in this subjective study is very similar to the previous methodologies (described in Section 5.2.1 and in Section 5.3.1), so only differences will be emphasized. Each participant took part in a two and half hour long gaming session that was performed in the testbed described in Figure 5.8.

In this study the same reasoning was applied when selecting games for testing as in Study S5 (i.e., to test games from different genres for which we hypothesize that the same codec configuration strategy might be applied in the case of reduced bandwidth availability). However, for Study S6 the selected games are slow-paced games, as compared to games tested in Study

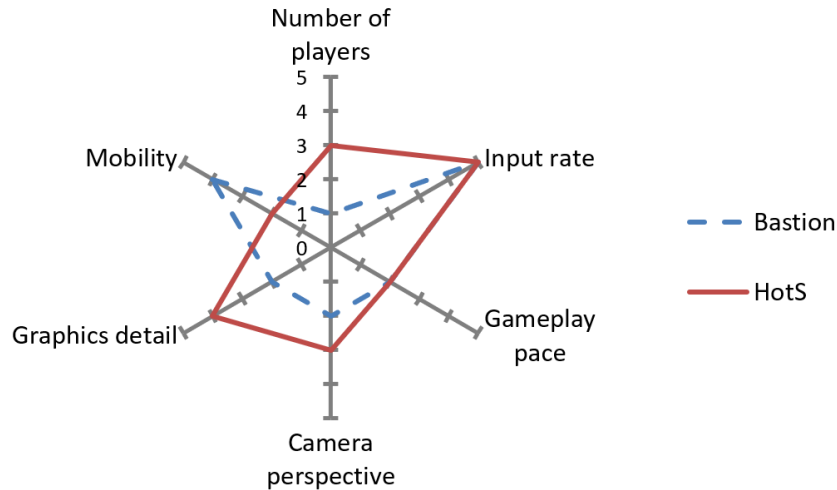

Figure 5.39: Comparison of game characteristics for the tested games in Study S6

S5. Thus, the two tested games in Study S6 were: *Bastion*, representing an adventure platform game, and *Heroes of the Storm (HotS)*, a multiplayer online battle arena game.

The differences between the tested games are illustrated in Figure 5.39 and according to the previously described categorization given in Section 5.2.1. With regards to the gameplay pace and input rate, Bastion and HotS are placed in the same category. In the dimension of mobility, Bastion is placed in category 4 as the player during gameplay is always moving across the screen, while HotS is plotted in category 2, as the player's character mostly stays in the same area that changes in later stages of the game. Further, the camera perspective dimension is slightly different for tested games, as the perspective is similar, however in the case of HotS, the camera position changes with character's movement, while for Bastion it stays in the middle of the screen until there is a transition to another scene. Finally, HotS has slightly more graphics details as compared to Bastion, especially when considering characters' outfits and background details. For Study S6, tested games were selected from different game genres, compared to previously tested games and with each other. However, both games are slowly-paced games and in some game characteristics dimensions similar to each other. We thus consider them to be suitable to test the hypothesis investigated in Study S5, however in this case applied to slow-paced games. Both games were played in HD-ready resolution (720p) with default graphics settings.

The participants in Study S6 were 39 students enrolled at the University of Zagreb: 30 male and 9 female, aged between 22 and 25 (median age 23). Similarly to Studies 4 and 5, the participants were instructed prior to the study to fill in an online questionnaire to gather relevant information about their previous overall gaming experience and gaming experience relevant to the tested games. As a result, 12 novice, 19 intermediate skilled and 8 self-reported experienced players took part in Study S6.

Unlike in Studies S4 and S5, in Study S6 both tested games were played in single-player

mode. Even though *Heroes of the Storm* is primarily a multiplayer game, during the experiments each of the players was playing with AI teammates against AI opponents, as a result of the pause feature not being supported in the game (and therefore the participants not being able to fill-in questionnaires in the middle of a game). Consequently, the impact of group composition was not investigated in the study, thus the participants were only organized in heterogeneous groups. Similar to the previous experiments, the participants from each test group were seated in the same experimental room, however in this study they were not able to see each others screens due to a physical barrier between monitors.

With regards to manipulated system parameters, the same exact video encoding parameters (bitrate, frame rate) on identical levels as in Studies S4 and S5 were tested: frame rate values of 25 fps, 35 fps, 45 fps and 60 fps, while bitrate values were 3 Mbps, 5 Mbps and 10 Mbps. Considering manipulated video encoding parameters and different games, a total of **24 different test conditions** were investigated in Study S6, with all conditions tested by each test group. With regards to the reference testing conditions, the participants played a tutorial phase under the best test conditions on cloud gaming clients, similar to Study S5. To exclude order effects during experiments, order of the games (which was played first in the experiment) was randomized for each of the groups.

5.3.5 Results from Study S6

Figure 5.40 shows the average subjective ratings of overall QoE for Bastion and HotS in the study across all test conditions. A one-way ANOVA was used to determine whether there are any statistically significant differences between the means of two tested games. There was statistically significant difference between QoE scores for Bastion and HotS, as determined by one-way ANOVA ($F = 6.944, p < 0.05$): QoE scores for both games differ for the same test conditions. Overall QoE scores for Bastion were on average higher compared to the scores for HotS. However, it can be observed that under constrained frame rate/bitrate the same video codec configuration could be used for both games to achieve highest QoE. For example, both games in the case of high network bandwidth availability (enabling a bitrate of 10 Mbps) had the highest QoE scores when the frame rate was 60 fps. Similarly, for the test conditions with bitrate of 3 Mbps, frame rate should be sustained at 60 fps level, which is clearly a different video encoding configuration strategy as compared to the results from Study S5 (for tested games in Study S5, lowering the frame rate of a game stream achieved higher QoE scores in the case of low bandwidth availability). Further, in the case of poor network conditions, it can be assumed that the participants did not perceive graphics quality degradations due to low bandwidth availability, as did players that tested faster paced games in Study S5, which could be possibly connected with the game dynamics of HotS and Bastion. In these games, the game scene does not change so often and so drastically as in SS3 and OMD, therefore low bitrate is

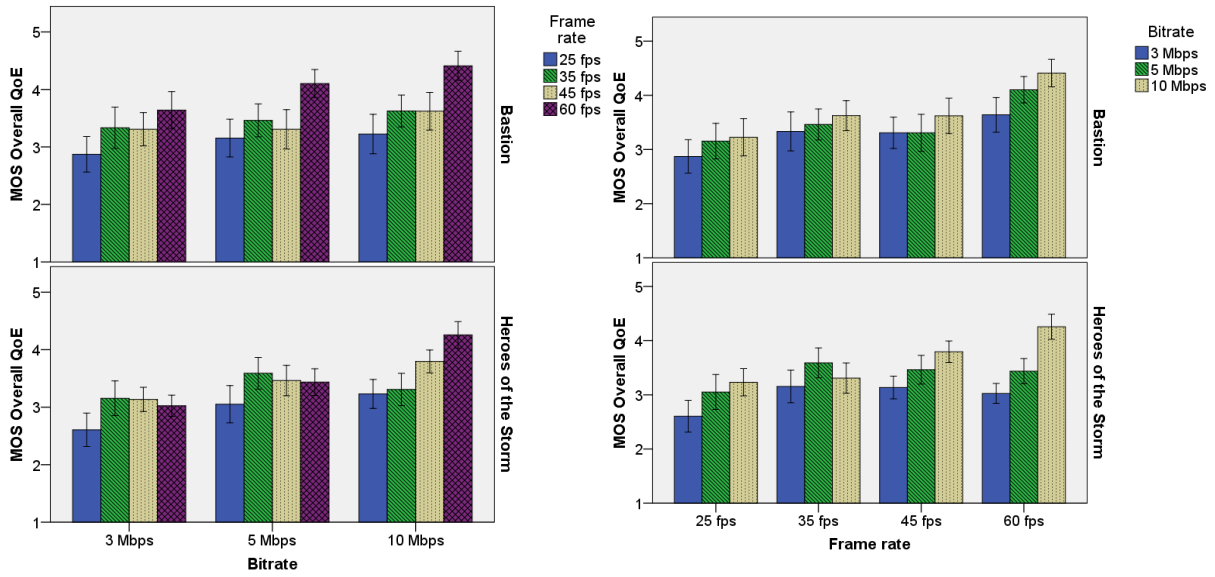

Figure 5.40: Subjective ratings of overall QoE (95% CI) in Study S6



Figure 5.41: Aggregated subjective ratings for each game in Study S6 under different video configurations

enough to support graphics details of these games at a frame rate of 60 fps.

A heatmap overview of collected data of QoE dimensions (Figure 5.41) shows the mean scores for overall QoE, graphics quality, and fluidity. Once again, Spearman’s rank-order correlation was computed to determine the relationship between overall QoE and measured QoE dimensions. As in previous Studies S4 and S5, there was a very strong, positive correlation between overall QoE and fluidity ($r_s = .741, p < .001$), and overall QoE and graphics quality ($r_s = .803, p < .001$).

In addition to differences in aggregated scores, the percentage of users willing to continue playing for each of the test scenarios is shown in Figure 5.42. Compared to Studies S4 and S5, a larger percentage of the players were not willing to keep playing across all test scenarios. Furthermore, a similar pattern of players’ willingness to keep playing for both tested games

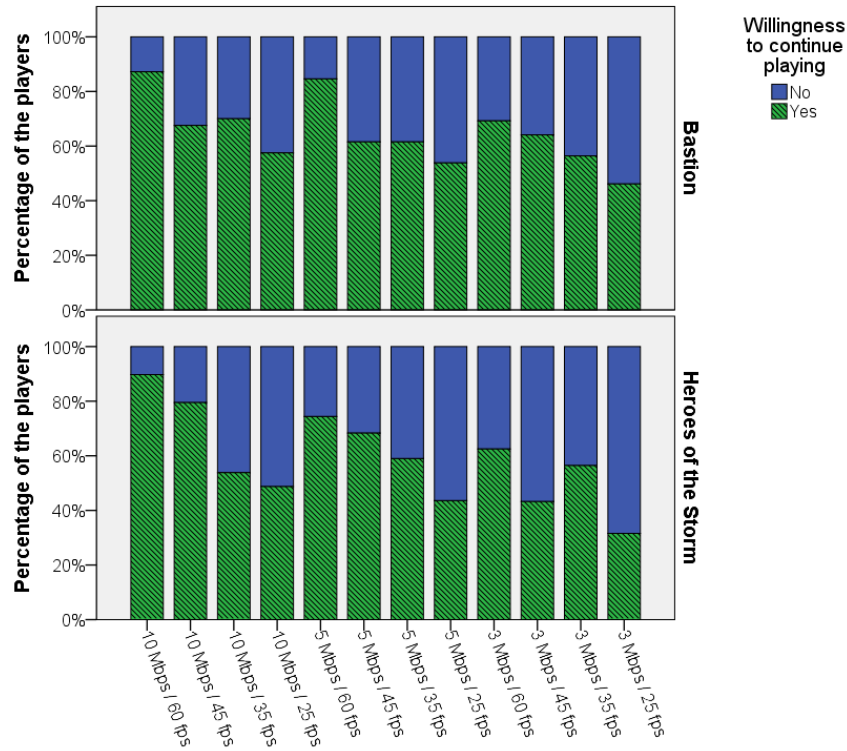

Figure 5.42: Willingness to continue playing under different test conditions for tested games in Study S6

can be observed at all bitrate levels. For example, at a bitrate of 10 Mbps, reducing frame rate resulted in an increase in the percentage of players not willing to continue for both games. Unlike Study S5 with fast-paced games, where the test scenario with 3 Mbps and 60 fps was rated the “worst” test scenario with more than a third of the players indicating they would stop playing, in this study the “worst” rated test scenario was the test scenario with 3 Mbps and 25 fps, with more than half of the players not willing to keep playing the tested games. This supports the previous assumption that slow-paced games should implement a different video encoding adaptation strategy as compared to fast-paced games.

User parameters

Once again, the impact of user parameters on QoE was investigated. Overall QoE ratings for Bastion and HotS grouped by player experience are shown in Figure 5.43. It can be visually observed that novice players gave lower QoE scores for both games compared to more experienced players, possibly as a result of their inability to perceive quality degradations and being less enthusiastic about playing tested games.

Additional per test scenario analysis was performed for both tested games (Figure 5.44). In the most scenarios novice players gave lower scores for both games compared to intermediate and experienced players, especially noticeable in the case of Bastion.

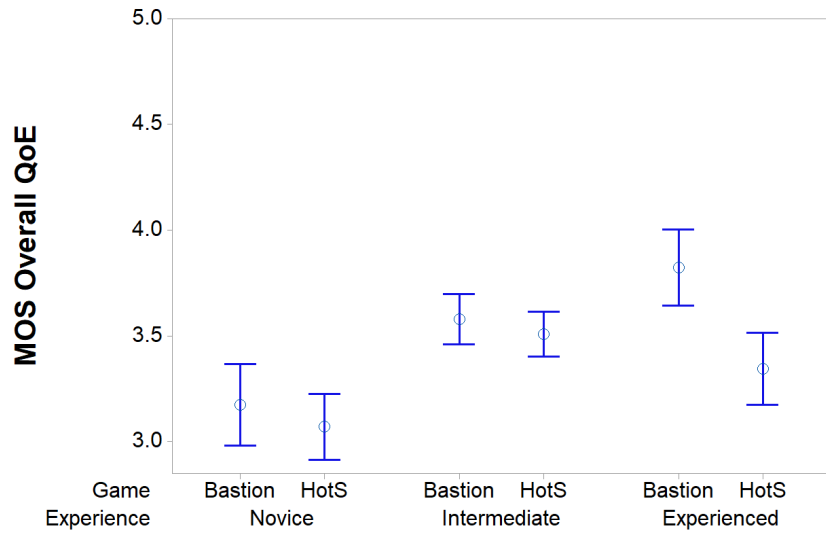

Figure 5.43: Subjective ratings of overall QoE (95% CI) for Bastion and HotS grouped by skill

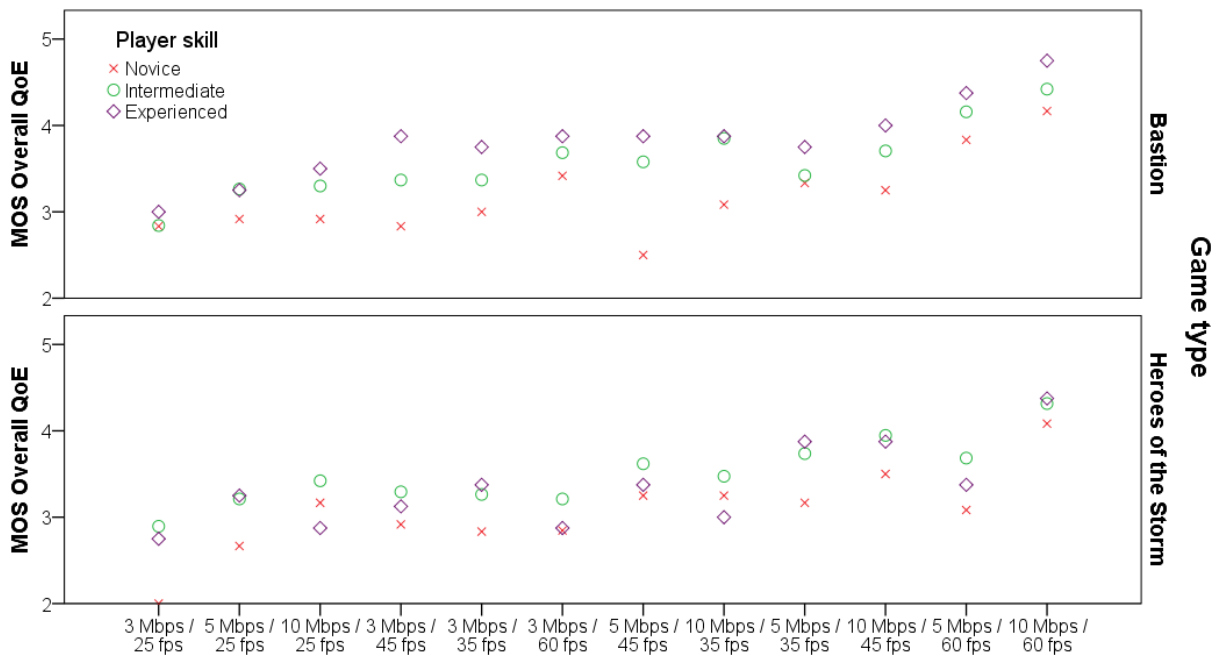

Figure 5.44: Mean ratings of overall QoE per skill level for different test scenario (scenarios arranged according to ascending mean QoE) for Study S6

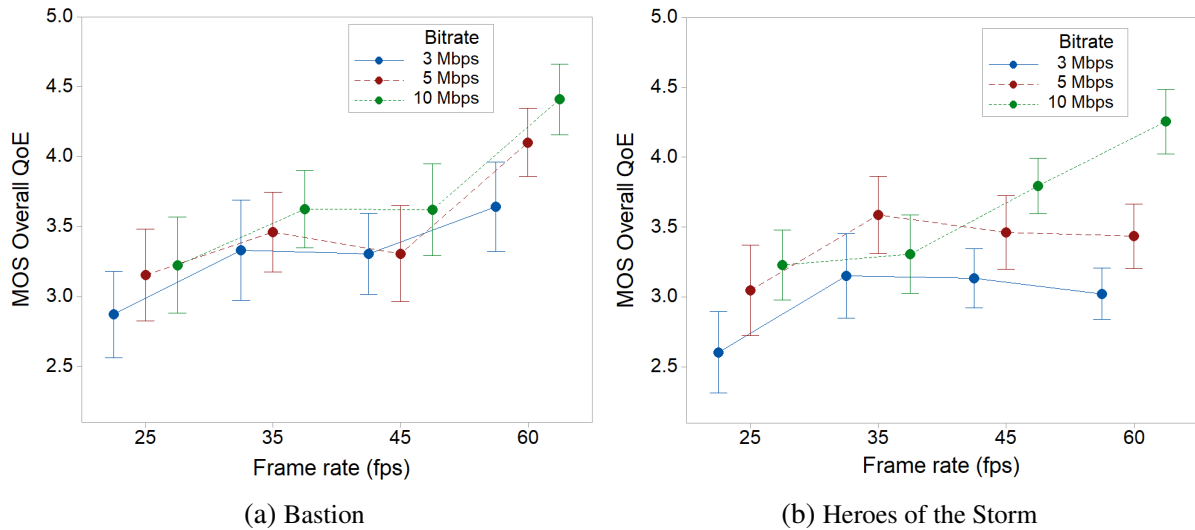

Figure 5.45: Impact of video parameters on overall MOS scores for Bastion and HotS in Study S6

System parameters

The impact of context factors on player's QoE was not investigated in Study S6, as the participants were playing games in a single-player mode. However, the impact of frame rate on subjective ratings of overall QoE under fixed bitrate for both games was investigated and is shown in Figure 5.45. For both tested games, we observe that an increase in frame rate, regardless of the bitrate level, led to higher QoE scores, contrary to the results in Study S5. This once again leads to the conclusion that slow-paced games (e.g., tested in Study S6) should have different video encoding configurations compared to fast-paced games, and that there should be a systematic approach for categorizing games and applying appropriate frame rate and bitrate adaptation strategies to achieve the highest possible QoE scores under various network availability constraints.

Additional QoE metrics beyond MOS

As in Studies 4 and 5, additional QoE metrics were computed based on the collected data: GoB, PoW, acceptance measures, and SOS.

Figure 5.46 plots the GoB ratio for all test scenarios. The GoB ratio for both games are highly similar: only a few test scenarios achieved a GoB ratio above 0.8, while the other scenarios were judged in-between 0.4 and 0.6 (except a single test scenario for each game that was rated very poorly). Unlike GoB ratios for fast-paced games (tested in Study S5), test scenarios with higher MOS mostly had higher GoB ratios (compared to adjacent scenarios shown in the graph).

The PoW ratio for all test conditions is shown in Figure 5.47. For both tested games it can be noticed that a third of the test scenarios had a PoW ratio higher than 0.2, unlike the PoW

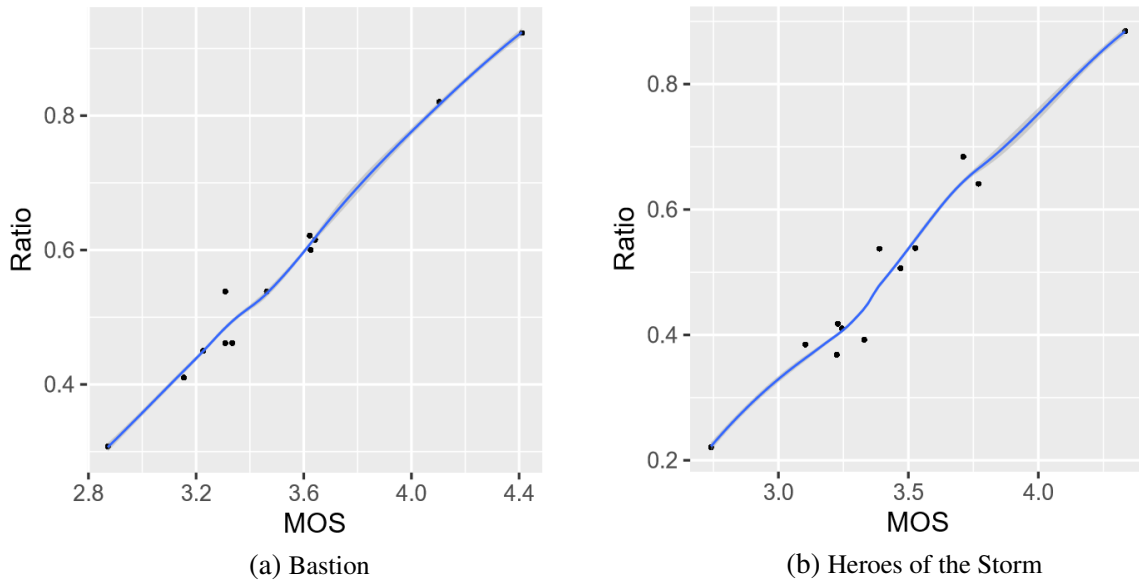

Figure 5.46: GoB scores for tested games in Study S6

ratio for fast-paced games in Study S5, where the same threshold (considering scenarios with lowest PoW scores) was at 0.1. Considering GoB and Pow ratios, it can be concluded that the participants in Study S6 were more stringent in evaluation of tested conditions compared to previous studies.

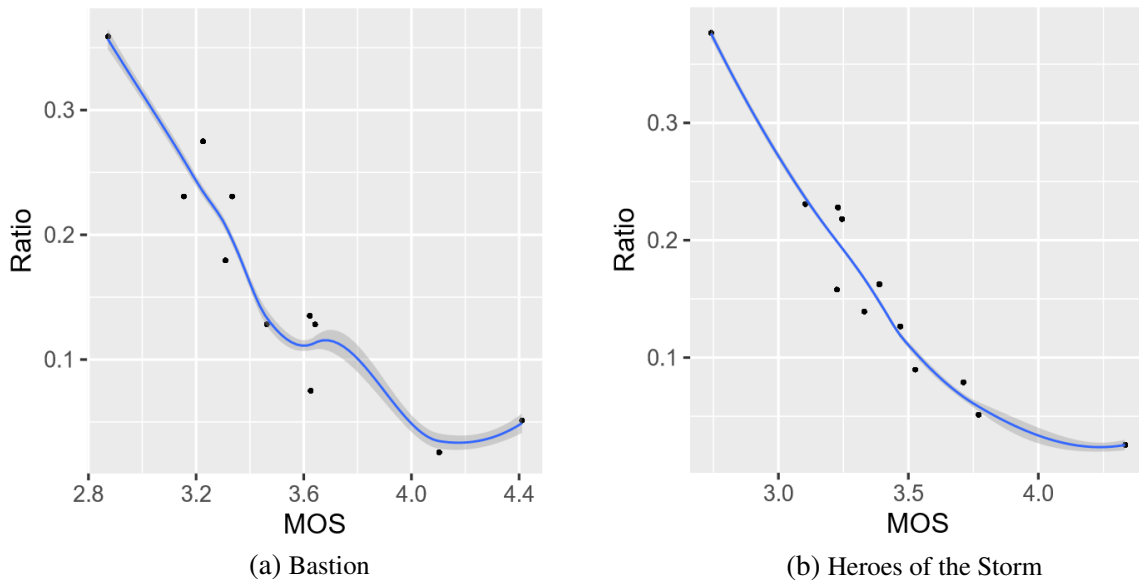

Figure 5.47: PoW scores for tested games in Study S6

The relationship between MOS and acceptability level is portrayed in Figure 5.48. Test scenarios with MOS of overall QoE 4 or higher had an acceptability rate more than 75% for both games, much lower as compared to fast-paced games from the previous study. However, lowering MOS from 4 by a value of 0.5 resulted with a decline of acceptability level to approximately 65%, the same as for tested games in Study S5.

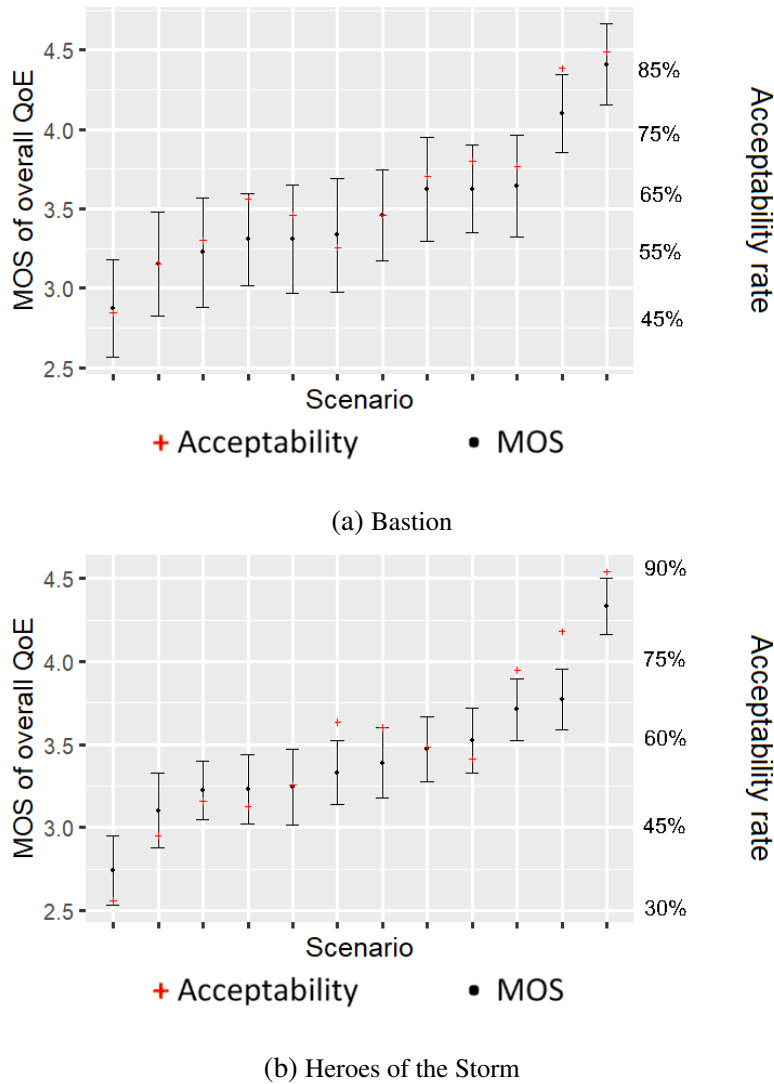

Figure 5.48: Acceptability ratios and MOS for QoE (with 95% CIs) per experiment for tested games in Study S6

As related to user score distributions, the SOS metric was calculated. The SOS parameter a was computed for each of the tested game. The values of SOS for both tested games were relatively small, as visible from Figure 5.49. The value of parameter a was relatively higher as compared to fast-paced games (for Bastion 0.2515 and HotS 0.2116) which suggests that players were more uncertain during scoring compared to the participants in Study S5.

5.3.6 QoE models derived from the data collected in Study S6

Analogous to the previous two subjective studies, the impact of different game types and video encoding parameters on player QoE was investigated in Study S6. Once again, the most appropriate QoE estimation model for collected data was determined to be the quadratic function of bitrate and frame rate derived in Study S4 (Equation 5.2).

The values of model parameters for tested games are summarized in Table 5.5. For QoE

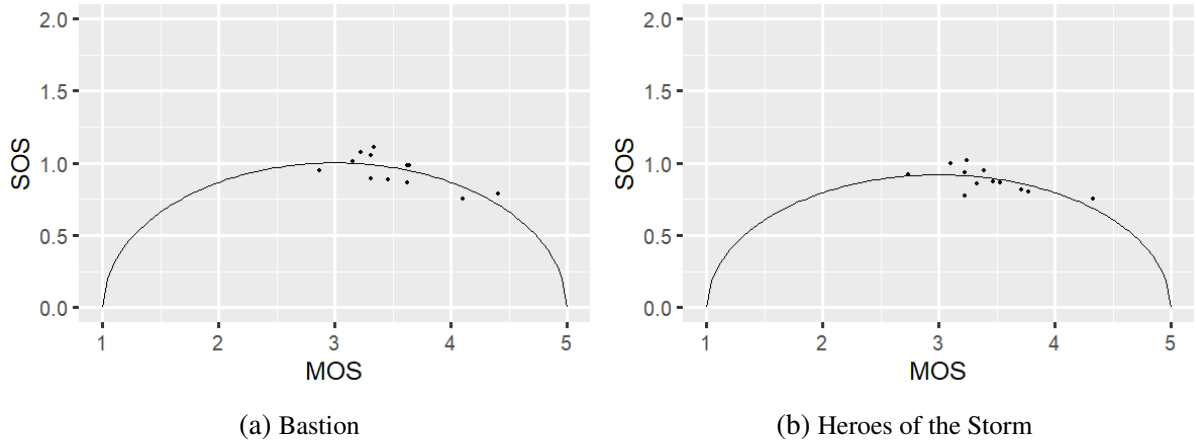

Figure 5.49: Distribution of Standard deviation of Opinion Scores (SOS) for tested games in Study S6

Table 5.5: The QoE models for tested games in Study S6

		Bastion				Heroes of the Storm			
		All	Novice	Intermediate	Experienced	All	Novice	Intermediate	Experienced
frame rate,	$\alpha_{g,1}$	$-1.16 * 10^{-2}$	$-9.79 * 10^{-2}$	$1.49 * 10^{-2}$	$5.68 * 10^{-2}$	$4.95 * 10^{-2}$	$7.79 * 10^{-2}$	$3.89 * 10^{-2}$	$3.75 * 10^{-2}$
bitrate (Mbps),	$\alpha_{g,2}$	0.115	$-3.68 * 10^{-2}$	0.221	$8.79 * 10^{-2}$	0.232	0.253	0.250	0.156
$I(\text{frame rate}^2)$,	$\alpha_{g,3}$	$3.14 * 10^{-4}$	$1.2 * 10^{-3}$	$5.5 * 10^{-5}$	$-4.31 * 10^{-4}$	$-6.26 * 10^{-4}$	$-7.81 * 10^{-4}$	$-4.8 * 10^{-4}$	$-7.72 * 10^{-4}$
$I(\text{bitrate}^2)$,	$\alpha_{g,4}$	$-9.37 * 10^{-3}$	$-2.98 * 10^{-3}$	$-1.43 * 10^{-2}$	$-7.14 * 10^{-3}$	$-2.13 * 10^{-2}$	$-1.45 * 10^{-2}$	$-2.17 * 10^{-2}$	$-2.95 * 10^{-2}$
frame rate:bitrate,	$\alpha_{g,5}$	$1.66 * 10^{-3}$	$2.98 * 10^{-3}$	$9.38 * 10^{-4}$	$1.53 * 10^{-3}$	$3.39 * 10^{-3}$	$1.36 * 10^{-3}$	$2.95 * 10^{-3}$	$7.24 * 10^{-3}$
Constant,	$\alpha_{g,6}$	2.711	4.575	1.950	1.699	1.184	0.104	1.546	1.827
R^2		0.896	0.759	0.911	0.906	0.888	0.869	0.914	0.803

models where all players, regardless of experience, are considered, it can be seen that both derived QoE models have similar goodness of fit. These QoE models are visualized in Figure 5.50. It can be visually observed that the QoE models have very similar contour pattern, implying that for Bastion and HotS it may be possible to utilize same video encoding adaptation strategy.

In addition to modeling QoE as a function of bitrate and frame rate, players' experience was also investigated, resulting with QoE modeling separately for different player experience levels. Obtained models are illustrated in Figure 5.51. By observing the contour plots, it can be noticed that novice players gave lower QoE scores for both games compared to more skilled players, while the plots for intermediate and experienced players have a similar contour shape for both games.

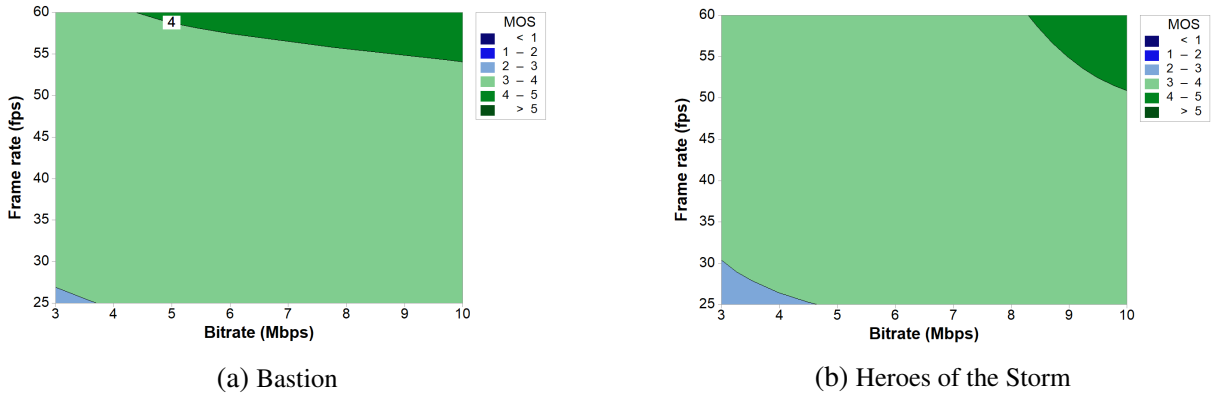

Figure 5.50: Illustrated QoE models for Bastion and Heroes of the Storm

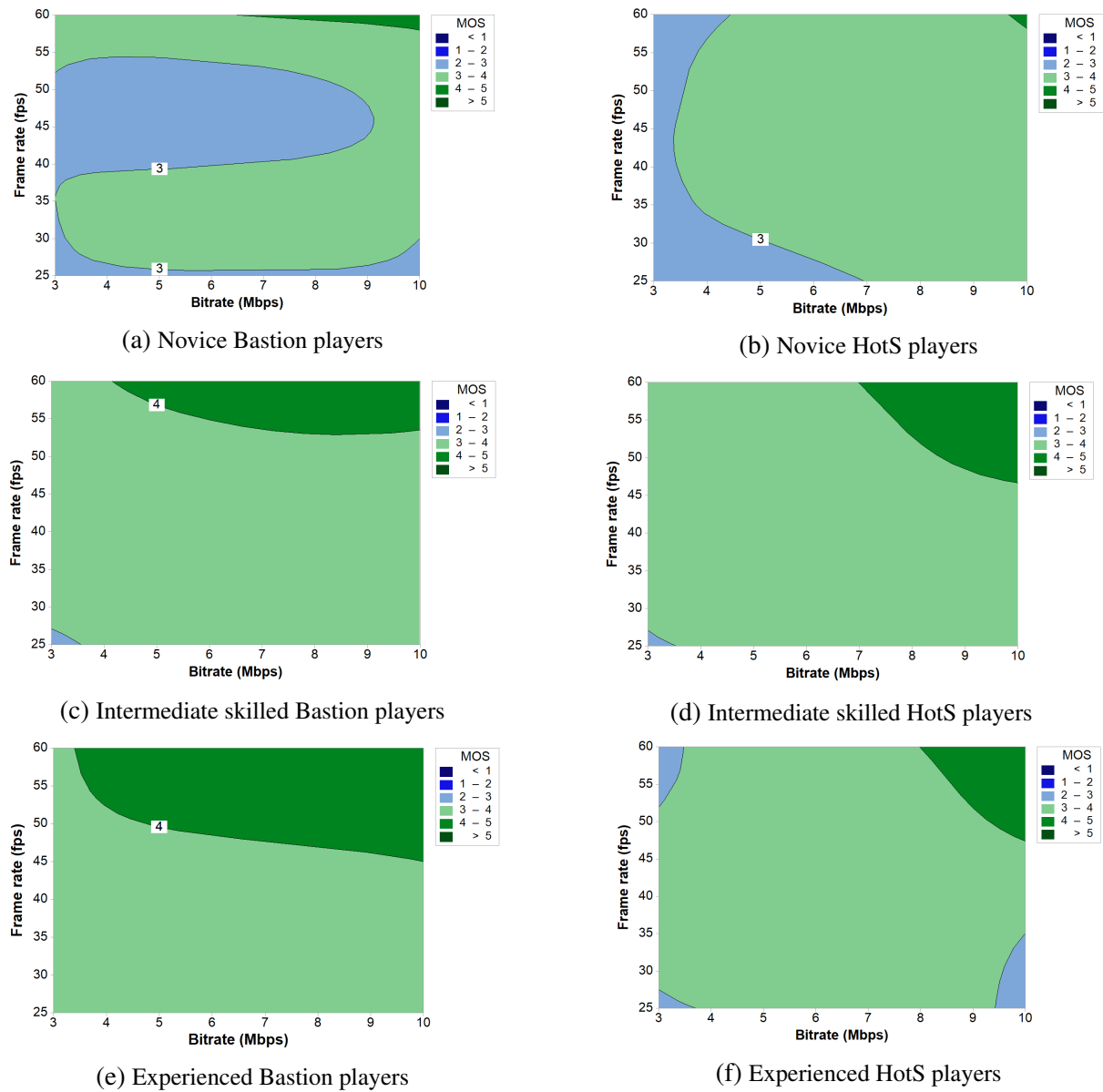

Figure 5.51: Graphical representation of QoE models for HotS and Bastion depending on player skill

Based on the presented results in the section, **the following key findings** can be highlighted for Study S5 and Study S6:

- Manipulation of frame rate could be utilized for achieving higher QoE levels under low network bandwidth availability, as in some cases graphics quality increase at the cost of gameplay smoothness leads to higher user's QoE (Study S5)
- Slow-paced games do not benefit from a decrease of frame rate under low network bandwidth availability (Study S6)
- Results indicate that different video encoding adaptation strategies should be applied for different types of games, and show that existing game categorization are not necessarily suitable for differentiating game types with a goal of optimizing users' QoE, as the same video encoding adaptation strategy could be applied for games in different game categories (Studies S5 and S6).

5.4 Chapter summary

Four subjective QoE studies, designed to investigate the impact of bitrate and frame rate on perceived graphics quality, perceived fluidity, and overall QoE were described in the chapter. Based on the subjective results presented in the chapter, we summarize the overall main findings, and link them to the research questions posed in the Introduction:

- Different video codec configuration strategies may be applied to different types of games in light of bandwidth availability constraints so as to maximize player QoE. This was shown using 2 games belonging to different genres (Studies S3 and S4): **RQ1, RQ2**,
- The QoE models indicate that there is no linear relationship between frame rate and QoE – in some cases it is better to deliver lower frame rate and increase graphics quality (shown in Study S5): **RQ1**,
- In certain cases, the **same** codec configuration strategy may be applied to games belonging to different genres (shown in Studies S5 and S6): **RQ3**,
- Current game classification approaches are not suitable for determining which video codec adaptation strategy to apply to a given game due to significant differences (in terms of graphics detail, gameplay pace, input rate, etc.) between games that are assigned to the same game category based on existing game classification (such as based on game genre). Therefore, we draw the conclusion that there is a need for a novel categorization of games beyond those typically used.

The following chapter explores which metrics and gameplay characteristics may be used to categorize games in a such way that the same video encoding adaptation strategy can be applied for all games belonging to the same category.

Chapter 6

Game categorization for cloud gaming

Conducted subjective QoE studies (described in Chapter 5) have shown that different video encoding adaptation strategies should be considered for different game types. In other words, selecting the appropriate video encoding parameters for different cloud games affects the efficiency of the service adaptation in terms of the impact on QoE. While there are traditional game genre-based classifications, and certain scientific approaches in classifying games (e.g., based on camera perspective [16]), missing so far is a systematic approach in differentiating between game characteristics specifically for cloud gaming. Current game genres are for the most part not defined based on a set of metrics, but more informally based on different types of game mechanics. Additionally, there are many games belonging to multiple genres which makes it hard to use existing genre classification in this approach.

Section 6.1 reports on evaluation of possibilities for categorizing games specifically for cloud gaming based on similar objective video metrics (temporal and spatial metrics) and gameplay characteristics (the intensity of user interaction), as suggested in our work in [15], with the aim of answering research question **RQ4**: *“Is it possible to objectively categorize games based on application-level metrics such that the same video encoding adaptation strategy (in terms of configuring bitrate and frame rate so as to maximize QoE) can be assigned for all games in the same category in light of decreased bandwidth availability?”*.

Secondly, Section 6.2 describes the methods for acquiring gameplay video traces and user input that will be used in the process of categorizing games. Finally, we propose a novel game categorization based on collected objective gameplay metrics (published in [35]) in Sections 6.3 and 6.4. The aim of the categorization is to obtain such game categories that the same video encoding adaptation strategy can be applied for all games grouped together. If the results of user studies do not match with derived game categories (in terms of the grouped games having similar QoE requirements), the categorization should be redefined, as will be described in Section 6.5.

6.1 Video characterization

To empirically quantify the differences between the games tested in the previous subjective QoE studies, aimed at deriving a game categorization for cloud gaming, both temporal and spatial characteristics of their video streams were analyzed. The first set of metrics is extracted according to ITU-T recommendation P.910 (4/2008): Spatial perceptual information (SI) and Temporal perceptual information (TI) [142].

SI is derived based on the Sobel filter which is used in image processing for edge detection [143]. The Sobel filter is used to identify the pixels that are most different from surrounding pixels. The identified pixels represent the edges in the image. By detecting edges in an image, it is possible to reduce and filter out redundant information from the image, while still retaining substantial information. Therefore, each video frame (luminance plane) at time n (F_n) is first filtered with the Sobel filter [$Sobel(F_n)$]. The standard deviation over the pixels (std_{space}) in each Sobel-filtered frame is then computed. This operation is repeated for each frame in the video sequence and results in a time series of spatial information of the scene. The maximum value in the time series (max_{time}) is chosen to represent the spatial information content of the scene. This process can be represented in equation form as:

$$SI = max_{time}\{std_{space}[Sobel(F_n)]\} \quad (6.1)$$

More details in the frame will result in higher values of SI.

TI is based upon the motion difference feature, $M_n(i, j)$, which is the difference between the pixel values (of the luminance plane) at the same location in space but at successive times or frames. $M_n(i, j)$ as a function of time (n) is defined as:

$$M_n(i, j) = F_n(i, j) - F_{n-1}(i, j) \quad (6.2)$$

$F_n(i, j)$ is the luminance value of the pixel at the i th row and j th column of the n th frame in time. The measure of temporal information (TI) is computed as the maximum over time (max_{time}) of the standard deviation over space (std_{space}) of $M_n(i, j)$ over all i and j .

$$TI = max_{time}\{std_{space}[M_n(i, j)]\} \quad (6.3)$$

More motion in adjacent frames will result in higher values of TI. For scenes that contain scene cuts, two values may be given: one where the scene cut is included in the temporal information measure, and one where it is excluded from the measurement (in our case no scene cuts were present and normal gameplay was recorded). TI and SI metrics have been extracted through predefined Matlab scripts (authored by Savvas Argyropoulos).

The second set of metrics are metrics proposed by Mark Claypool in his work on motion and scene complexity of video games [144]. As reported in the paper, typical video encoding characteristics (e.g., the size of intra-coded macroblocks) could be used to objectively measure video motion and scene complexity. Therefore, the following metrics based on video characteristics have been proposed for measuring video motion and scene complexity: Percentage of Forward/backward or Intra-coded Macroblocks for the temporal aspect of the video (motion in subsequent images), and Intra-coded Block Size for the spatial aspect of video (scene complexity).

The logic behind PFIM as a measure of video motion is the following: motion in the videos is correlated with the percentage of encoded macroblocks, i.e., a video with visual changes from frame to frame will have these changes encoded (either by neighboring blocks or independently of other blocks), while video without visual changes can skip much of the encoding. Therefore, by analyzing video sequence and calculating the aforementioned percentage, it is possible to obtain an accurate estimation of the video motion as perceived by the end user.

On the other hand, IBS represents a new measure of scene complexity: if the scene is simple, there is not much information to be encoded. As a result, the intra-coded block size will be small. If the scene is complicated, the IBS will be large to contain all the information.

PFIM and IBS metrics were extracted using python scripts created by Mark Claypool [144].

6.2 Acquiring a dataset of gameplay video traces

Motivated by the results of the conducted user studies that demonstrated that commonly used game classifications (e.g., in terms of graphics detail, gameplay pace, input rate, etc.) are not necessarily applicable when creating (or identifying the need for) different cloud gaming QoE models, we explored the potential for alternative ways of categorizing games that could be subsequently utilized for selecting optimal video encoding adaptation strategies.

6.2.1 Preliminary analysis of video game traces

As an initial step, our aim was to check whether there are differences and/or similarities in video streams between the games tested in previously conducted user studies (only games tested in Studies S4 and S5), i.e., we aimed to empirically verify if objective video metrics could indeed be used to differentiate between games. Computed video metrics were plotted and are shown in Figure 6.1. Each of the dots represents one gaming session played by the same player (720p resolution with 30 fps and a bitrate of 10 Mbps). The FRAPS application¹ was used to record gameplay sessions that lasted 30 seconds each. The gaming sessions included distinct game

¹FRAPS, <http://fraps.com/>

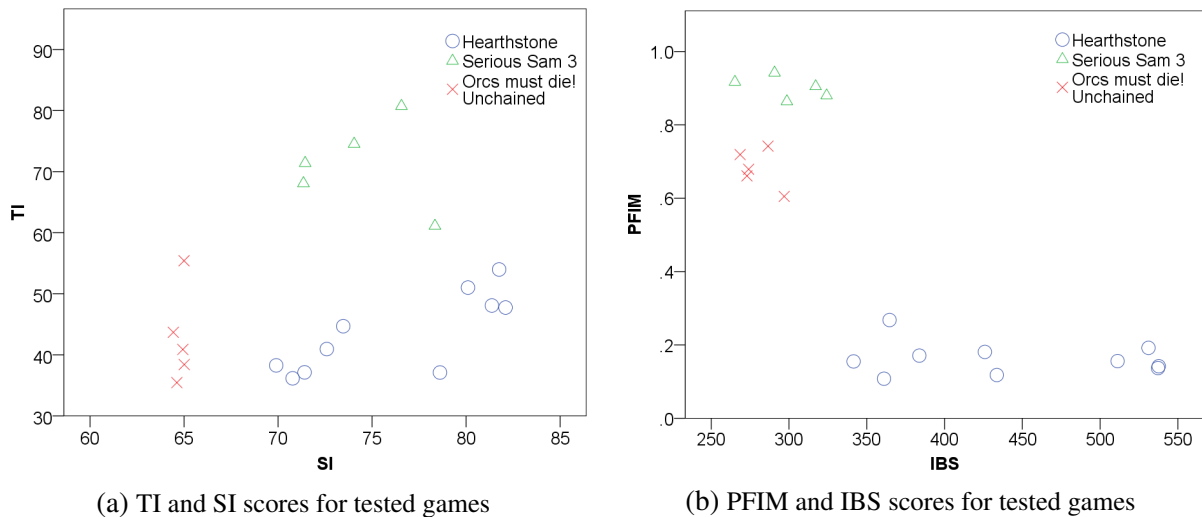

Figure 6.1: Scores for different video metric for tested games

scenes most commonly associated with the tested game’s gameplay. With regards to TI and SI metrics, it can be observed that there are indications of clustering behavior of the video traces for each separate game, but there is a lack of a cluster presence that was expected for the video traces of SS3 and OMD based on the results reported in Study 5 (similar QoE ratings for SS3 and OMD). Nevertheless, TI and SI video metrics for SS3 and OMD are more condensed in comparison with HS, indicating that SS3 and OMD gameplay in terms of game actions is mainly consistent, while for HS it is more dynamic (e.g., choosing cards, waiting for an opponent, playing cards with complex animations, etc.). With respect to PFIM and IBS metrics, both internal (video traces of a single game are grouped together) and external clustering (video traces of multiple games are grouped together) behavior can be observed for tested games, as would be expected from this set of video metrics derived for specific purposes of analyzing motion and scene complexity of gameplay videos. Even though there is more spread for the spatial component for HS in comparison with the other two games, the similarity in values of these video metrics can be clearly observed for SS3 and OMD, along with the distinction of these two games and HS (higher temporal and lower spatial scores). These results support the claim that categorization of video games could be achieved by analyzing objective video metrics of cloud gaming video stream, but also that existing well-known video metrics (TI and SI) may not be appropriate for this analysis.

6.2.2 Methodology for data collection

The main prerequisite for performing video game categorization based on objective video metrics for cloud gaming was obtaining a large set of video game traces for analysis purposes. Therefore, video game traces were collected in a laboratory environment slightly different from the one used during our previous user studies. Similar to the user studies, Valve’s Steam In-

Home streaming platform was used as the cloud gaming environment. The Steam In-Home Streaming client in this case was installed on an HP Probook 4530s laptop (Windows 10 OS with Intel 2.5 Ghz i5 processor, 4GB RAM and AMD Radeon HD 7400M graphic card), while the Steam In-Home Streaming server was installed on a Windows PC desktop (Windows 8 desktop with Intel 3.6 Ghz i7 processor, 8GB RAM and NVIDIA GeForce GTX 970 graphic card). The PC server and laptop client were connected via a wireless access point (both the PC server and the laptop client had a wired connection). The FRAPS application was used once again to record gameplay sessions. All video traces were recorded at a video encoding frame rate of 30 fps and 10 Mbps video bitrate. Tested games were played in HD-ready resolution (720p) with default graphics settings. For each of the tested games, between 5-10 gameplay video traces were recorded that lasted exactly 30 seconds each in order to obtain a large enough sample of gameplay for each game. Alongside gameplay recording, the intensity of user interaction was also measured as the APM metric, thus collecting mouse and keyboard input during gameplay by using the Mousotron application ².

With respect to tested games, gaming sessions of 25 different video games were recorded. During the selection of games, the traditional game genres were represented with at least two games. The set of video games for which gameplay was recorded is shown in Table 6.1. As a result, **225 different video traces** were gathered that were included for further analysis. For each of the recorded video traces, the following temporal and spatial characteristics were calculated: Spatial perceptual information, Temporal perceptual information, Percentage of Forward/backward or Intra-coded Macroblocks, and Intra-coded Block Size.

6.3 Analysis of acquired video traces

To identify game categories, cluster analysis was performed on gathered information about recorded video traces. Due to the nature of the problem and type of collected data, k-means clustering was selected as a clustering technique which is commonly used for performing this type of unsupervised learning tasks. As distance computation in k-means weights each dimension equally, the data was standardized prior to clustering. Since k-means clustering requires the number of clusters k as an input parameter, determining the most appropriate number of clusters in the data set was a primary objective. In doing so, one of the most widely used internal clustering validation measures for k-means clustering was utilized - silhouette analysis [145]. Silhouette analysis measures how well an object is clustered (similar with other objects in the same cluster) as compared to other clusters. The silhouette values range from -1 to 1, where a value closer to 1 indicates that the object is well clustered, while a value closer to -1 estimates that the objects should be moved to another cluster. Additionally, due to the low-dimensionality

²Mousotron, <http://www.blacksunsoftware.com/mousotron.html>

Table 6.1: Selected games for recording video game traces

Game genre	Selected games
Role-playing game	Bastion, Fable II, The Elder Scrolls V: Skyrim, South Park: The Stick of Truth, Orcs Must Die! Unchained
Action game	Batman: Arkham Origins, Joe Danger 2: The Movie, Rocket League
Racing game	Burnout: Paradise, GRID 2, Trials: Evolution
Strategy game	Civilization V, Company of Heroes 2, Medieval II: Total War, Warhammer 40,000:Dawn of War – Dark Crusade
First-person shooter	Counter Strike: Global Offensive, Far Cry 2, Serious Sam 3
Multiplayer online battle arena	DotA 2, Heroes of the Storm
Card game	Hearthstone, Poker Night 2
Other genres	Runner 2, The King of Fighters XIII, Halo: Spartan Assault

of the data set, we were able to perform a thorough dimension reduction analysis aimed at avoiding excessive sparseness and dissimilarity of the collected video traces.

The silhouette analysis was limited up to a maximum of 10 clusters in the data set, along with reducing dimensions of the data set in such a way that associated metrics (TI/SI and PFIM/IBS) were still grouped together. The aim was to explore in detail the separation distance between the clusters. An upper limit of 10 was set, as it was considered that a larger number of clusters (resulting in the same number of different adaptation strategies), would be impractical from a realistic deployment perspective. From a practical cloud gaming service provider point of view, it would likely not make sense to implement a large number of different video encoding adaptation strategies due to the complexity of deriving such strategies using subjective tests, implementation complexity introduced with multiple strategies, as well as cost to benefit ratio.

The results of silhouette analysis combined with dimension reduction are presented in Figure 6.2. Overall, it can be observed that with reducing the number of dimensions, k-means clustering achieves better clustering results, noticeable by the higher values of average silhouette width. When all data dimensions (metrics) are considered, the recommended number of clusters by silhouette analysis is the maximum value of ten clusters, confirming the assumption that a high number of dimensions can induce a high dissimilarity in observations, resulting with poor clustering results. As can be seen from the results of the cluster analysis, the APM metric was omitted in the process of reducing the number of dimensions, thus showing either that this

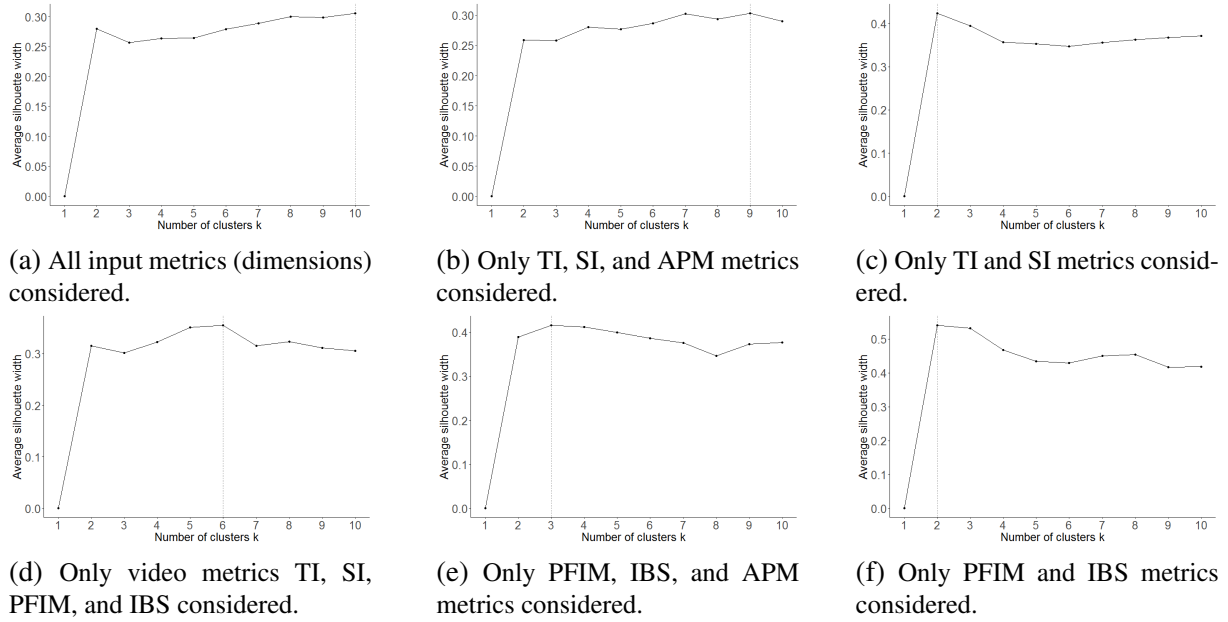

Figure 6.2: The impact of the chosen number of clusters on the silhouette coefficient for different sets of input metrics. The complete set of collected metrics includes: SI, TI, PFIM, IBS, average actions per minute (APM).

measure of player interactivity is likely not appropriate in the context of game categorization for cloud gaming or its impact on forming clusters is mostly covered by another dimension (e.g., temporal dimension). Furthermore, when comparing clustering results with different sets of video metrics, it can be noticed that PFIM and IBS metrics achieve better clustering results than TI and SI metrics, as expected due to the previously described origin of the PFIM and IBS video metrics.

The best clustering results are achieved in the case when only PFIM and IBS video metrics are included in clustering analysis, with average silhouette width higher than 0.5. It should be noted that average silhouette width above 0.5 means that a reasonable clustering structure has been found, while lower values in most cases imply that clustering results could be artificial, as reported in [146].

6.4 Clustering results for two clusters

Considering clustering options and the analysis described in the previous section, at this stage of our research it was decided to use only the PFIM and IBS metrics. **The selected the number of clusters was set to two**, as this corresponded to the highest average silhouette width across all clustering results. The silhouette plot of the selected data for k-means clustering when k equals 2 is shown in Figure 6.3. The average silhouette width of the cluster over all data is 0.54, estimating that data is tightly grouped in the clusters.

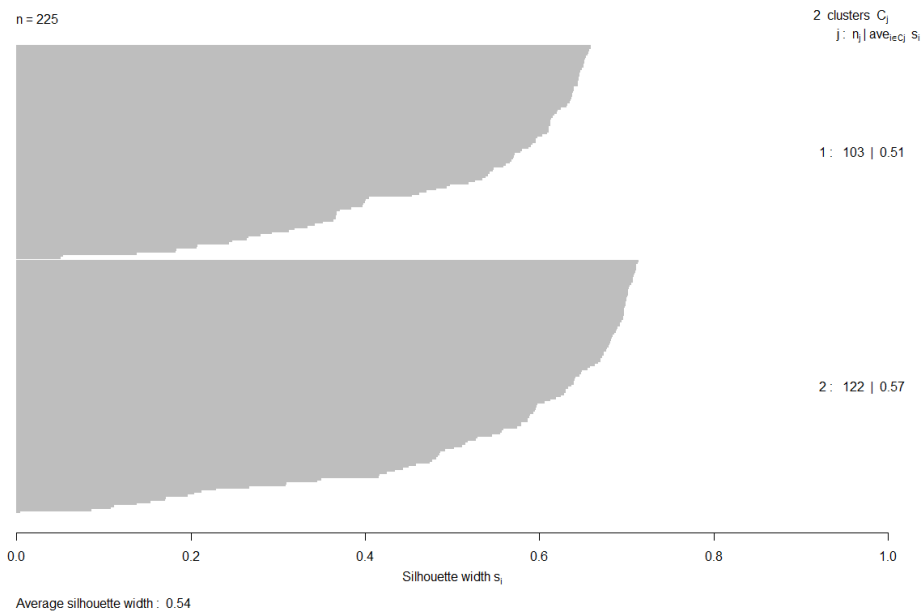

Figure 6.3: Silhouette plot of the collected data for $k = 2$

The results of applying the k-means clustering method with 2 clusters on the collected data set are shown in Figure 6.4. The obtained clusters are highly independent and 80% of the games have 100% of their videos placed in the appropriate cluster. The majority of games with less than 100% accuracy of video cluster placement have values of 80% and 90% of correct cluster placement with 60% being the lowest value. For games with gameplay videos that are not consistently clustered in the same cluster (e.g., South Park: The Stick of Truth), an analysis of a larger set of recorded gaming sessions (e.g., 10 videos) is necessary to determine which of the clusters is more fitting for the game. To visualize the obtained clusters, a scatter plot of analysed objective video metrics is included (Figure 6.5). It can be observed that the fast-paced cluster (referred to as **Cluster FP**) contains games with high video motion that contains a smaller amount of video information (high PFIM, low IBS). On the other hand, the slow-paced cluster (referred to as **Cluster SP**) contains games with low video motion, however when the objects in the screen move, the coding block size is quite large (low PFIM, high IBS). The cluster centroids (a set of metrics [PFIM, IBS]) are [0.283, 445.539] (standardized [-0.942, 0.712]) for Cluster SP and [0.811, 284.028] (standardized [0.795, -0.601]) for Cluster FP.

With respect to game genres, we can notice from Table 6.4 that games that belong to the same traditional video game genre may be clustered into different clusters (e.g., Fable II, Skyrim). Assuming that in this case a video encoding adaptation strategy which applies to all of the games from the same game genre is employed, resulting QoE-driven service adaptation would likely be inefficient for some games. Likewise, it can be observed that there are games

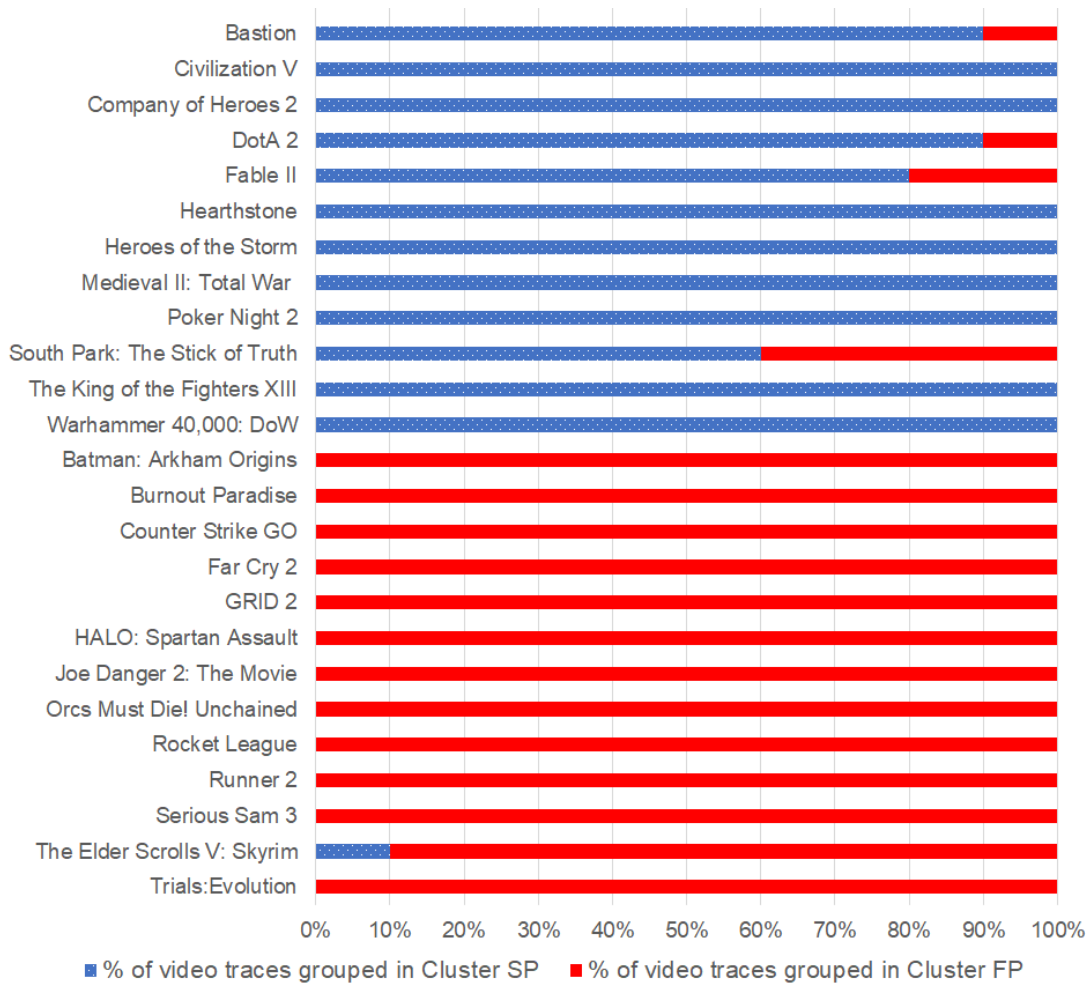

Figure 6.4: k-means clustering results of video games for k=2

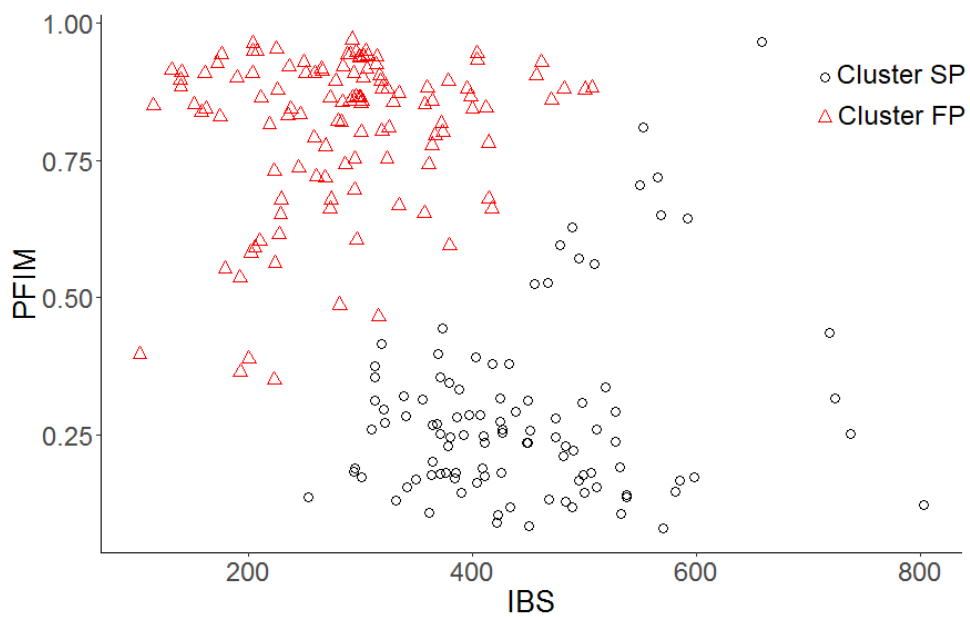

Figure 6.5: PFIM and IBS scores for different gameplay traces. Each point corresponds to metrics derived from one gameplay trace lasting 30 seconds

that are clustered into the same cluster, even though they are not from the same game genre (e.g., SS3 and OMD) and are completely different in terms of gameplay and camera perspective which are commonly used to differentiate video games. However, it should be noted that clustering with two clusters was performed prior to conducting the subjective study that involved HotS and Bastion. Results of that study (Study S6) showed that the adaptation strategy for HotS and Bastion should be different from that of Hearthstone, as frame rate and bitrate changes have significant impact on player's QoE for HotS and Bastion, while Hearthstone's QoE is not impaired by the same video quality changes. Therefore it was concluded that clustering games into only two clusters is inadequate, with there being a need to additionally split Cluster SP further. Thus a new clustering analysis was conducted aiming to separate HS and other similar games into a different cluster (corresponding thus to a different video encoding adaptation strategy), as explained in the following section.

Impact of player style and experience level on objective video metrics

In addition to the 225 video traces used for cluster analysis, additional gameplay traces were collected by recording players with different self-reported experience levels so as to test the impact of player style and experience level on obtained objective video metrics (and consequently game categorization). An additional study was performed with 12 new participants differing in self-reported experience level (3 novice, 3 experienced, and 6 intermediate skilled players). All additional players recorded 3 gameplay traces for two chosen games: HotS (which was chosen as a representative game from Cluster SP) and SS3 (chosen as a representative game from Cluster FP). This resulted in an additional 72 video traces. After computing the objective video metrics (PFIM and IBS) for these games, results showed that in all cases HotS was categorized into Cluster SP, and SS3 into Cluster FP, thus indicating that previous player gaming experience and playing style did not have an observable impact on the categorization.

6.5 Clustering results for three clusters

To separate games such as HS from other tested slow-paced games, the clustering analysis with only PFIM and IBS metrics was performed for a cluster size of three. The clustering attempt with PFIM and IBS metrics did not achieve the goal of separating HS into a different cluster from HotS and Bastion. For that reason, the previously omitted APM metric was included in our subsequent clustering analysis. The silhouette plot of the selected data for performed k-means clustering with three metrics is shown in Figure 6.6. The average silhouette width of the cluster over all data is 0.41, slightly less compared to clustering results with $k=2$.

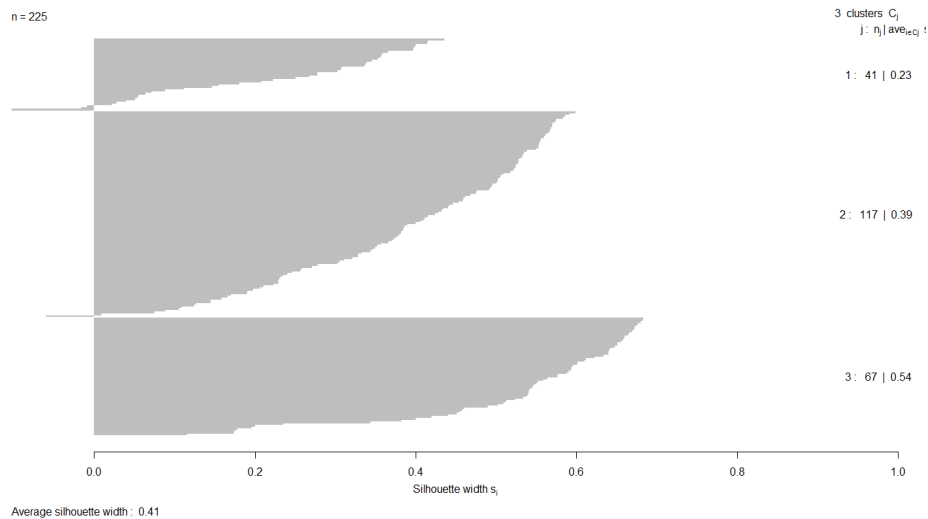

Figure 6.6: Silhouette plot of the collected data for $k = 3$

The results of applying the k-means clustering method with 3 clusters on the collected data set are shown in Figure 6.7. The obtained clusters are not as highly independent as in the clustering results reported for $k=2$, as less than 70% of the games have 100% of their videos placed in the appropriate cluster. To visualize the obtained clusters, a scatter plot of analyzed objective video metrics is included (Figure 6.8). Similar to the clustering results for $k=2$, it can be observed that Cluster FP contains games with high video motion that contains a smaller amount of video information (high PFIM, low IBS). On the other hand, Cluster SP was separated into two clusters: a cluster with slow-paced games with low APM (referred to as **Cluster SP-L**) and a cluster with slow-paced games with high APM (referred to as **Cluster SP-H**). Both these clusters contain games with low video motion, but when the objects in the screen move, the coding block size is quite large (low PFIM, high IBS). The difference that separates these two clusters is the APM metric, as for Cluster SP-H (Bastion, HotS) the intensity of user inputs is on average higher than for Cluster SP-L (HS). The differences and similarities between obtained three clusters are summarized in Table 6.2. The cluster centroids (a set of metrics [PFIM, IBS, APM]) are $[0.417, 478.157]$ (standardized $[-0.499, 0.978, 1.072]$) for Cluster SP-H, $[0.824, 282.797, 130.256]$ (standardized $[0.838, -0.611, 0.127]$) for Cluster FP, and $[0.217, 415.674, 46.764]$ (standardized $[-1.158, 0.469, -0.878]$) for Cluster SP-L.

Although the used clustering validation measures (referring to silhouette analysis) suggest that PFIM, IBS and APM give the strongest results in terms of clustering division, it should be acknowledged that additional user studies may need to be performed to further validate the clustering results when comparing more encoding strategies, and to justify the use of PFIM and IBS metrics over other metrics (e.g., SI and TI). Nevertheless, the clustering results clearly demonstrate the possibility of video game categorization based on objective video metrics that could be used for deriving video encoding configuration strategies to achieve high QoE for each

Table 6.2: Differences between derived clusters regarding video metrics and gameplay characteristics

Cluster	Video metric and gameplay characteristics		
	PFIM	IBS	APM
Cluster FP	high values	low values	high values
Cluster SP-L	low values	high values	low values
Cluster SP-H	low values	high values	high values

categorized video game.

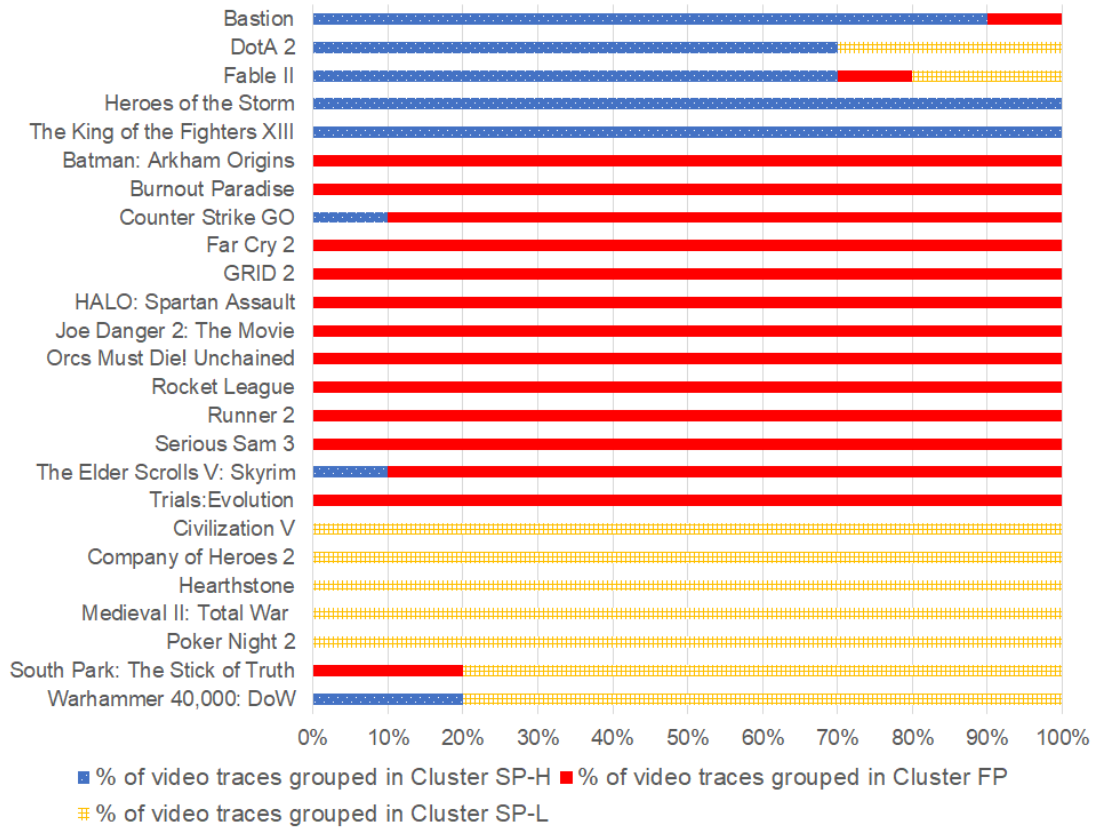

Figure 6.7: k-means clustering results of video games for k=3

Based on the presented results in the chapter and the obtained clusters, we propose **the following game categories:**

- Game category FP: contains games with high video motion that contains a smaller amount of video information,
- Game category SP-H: contains slow-paced games with high APM, and
- Game category SP-L: contains slow-paced games with low APM.

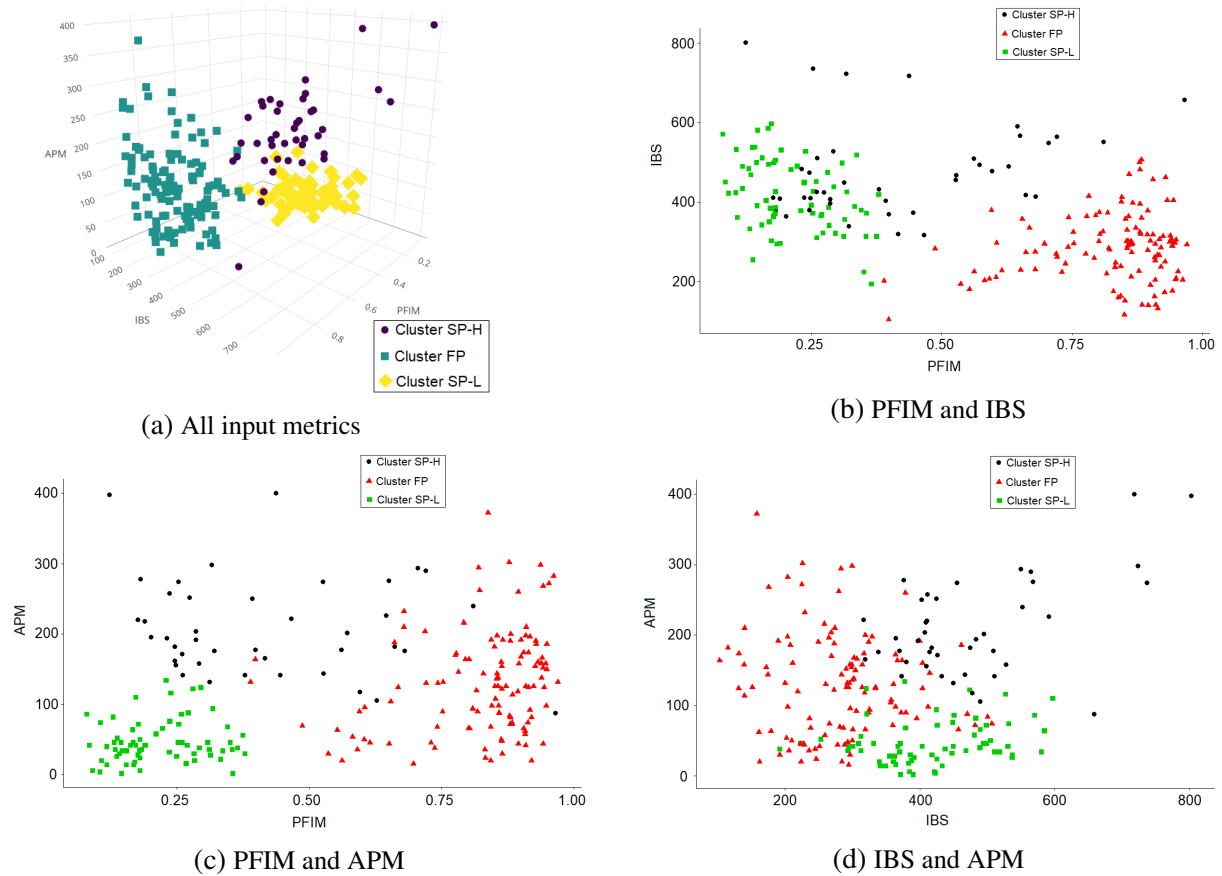

Figure 6.8: Visualization of the obtained clusters, analyzed according to input metrics used in clustering (PFIM, IBS, APM)

6.6 Chapter summary

This chapter summarizes our efforts in obtaining a novel game categorization for cloud gaming based on similar objective video metrics and gameplay characteristics. It describes the methodology for collecting gameplay video traces and user input that is used in the subsequent categorization. Our initial investigation and cluster analysis yielded 2 clusters: Cluster FP (contains games with high video motion that contains a smaller amount of video information) and Cluster SP (contains games with low video motion, however when the objects in the screen move, the coding block size is quite large). Subsequent study proved the need for extending the number of cluster to three, finally yielding with following game categorization: Game Category FP (contains games with high video motion that contains a smaller amount of video information), Game Category SP-H (the cluster with slow-paced games with high APM), and Game category SP-L (the cluster with slow-paced games with low APM). The proposed game categorization is utilized in the following chapter for assigning appropriate video encoding adaptation strategies for cloud gaming.

Chapter 7

Video encoding adaptation strategies for cloud gaming

In the previous chapter, we proposed a categorization that groups games into three game categories based on temporal and spatial information, and actions per minute. With regards to the games that were used for test purposes in our user studies (described in Chapter 5), *Bastion* and *Heroes of the Storm* are assigned to **Game category SP-H**, *Serious Sam 3* and *Orcs must die: Unchained!* to **Game category FP**, while *Hearthstone* is assigned to **Game category SP-L**. To assign appropriate video encoding adaptation strategies for each of the obtained game categories, we derived new QoE models per category, as described in Section 7.1. Furthermore, three different adaptation approaches for maximizing users' QoE under low network bandwidth availability are proposed in Sections 7.2, 7.3, and 7.4 .

7.1 QoE models and adaptation strategies for three game categories

To apply an appropriate video encoding adaptation strategy for each obtained game category, new QoE models for the categories were derived based on the previously collected data. For Game category FP, the QoE model was developed based on the grouped data (the predictor game type was omitted in the analysis) of subjective ratings of overall QoE for tested games (SS3 and OMD) in Study S5 (reported in Section 5.3.1), while for Game category SP-H the data for tested games (HotS and Bastion) in Study S6 (described in Section 5.3.4) was used (the predictor game type was excluded from the analysis). The previously derived QoE model for HS was selected to represent Game category SP-L (reported in Section 5.2.2). As our previous analyses and modeling results showed that a quadratic function of bitrate and frame rate was the most accurate way to estimate MOS for the given data, we once again use the same quadratic function (Equation 5.2) to model MOS for the game categories. Derived QoE models (shown

Table 7.1: QoE models for proposed game categories

	Game category SP-H	Game category FP	Game category SP-L
frame rate, $\alpha_{g,1}$	$1.91 * 10^{-2}$	$4.5 * 10^{-2}$	$3.4 * 10^{-2}$
bitrate (Mbps), $\alpha_{g,2}$	0.173	0.247	$6.06 * 10^{-2}$
$I(\text{framerate}^2)$, $\alpha_{g,3}$	$-1.59 * 10^{-4}$	$-6.36 * 10^{-4}$	$-4.54 * 10^{-4}$
$I(\text{bitrate}^2)$, $\alpha_{g,4}$	$-1.53 * 10^{-2}$	$-1.88 * 10^{-2}$	$-4.81 * 10^{-3}$
frame rate:bitrate, $\alpha_{g,5}$	$2.54 * 10^{-3}$	$1.77 * 10^{-3}$	$8.63 * 10^{-4}$
Constant, $\alpha_{g,6}$	1.948	2.02	3.47
R^2	0.836	0.919	0.782

in Table 7.1) are used in the case study reported in the following chapter.

The process of assigning a new game to derived game categories and selecting appropriate video encoding adaptation strategy to the game is clarified in Algorithm 1. The algorithm illustrates the process of categorizing a new game, given multiple video traces of the gameplay and previously found clusters. PFIM, IBS, and APM scores are calculated and standardized for newly recorded video traces. For each of the video traces the distance to cluster centroids is determined, and each video trace is then assigned independently to the closest cluster. A cluster that has the most video traces assigned to it is subsequently selected as the main cluster for the new game. The service provider then assigns the appropriate video encoding adaptation strategy to the game based on assigned game category.

As conducted subjective studies have shown, different video encoding adaptation strategies should be applied to different games (therefore to the game categories) in light of bandwidth availability constraints to maximize player's QoE. For games belonging to Game category SP-H, frame rate should be kept at higher rates while lowering bitrate due to network constraints, while for games belonging to Game category FP frame rate should be adjusted depending on available bitrate.

In the following sections, the following three adaptation approaches for deriving per cluster adaptation strategies proposed:

- fine-grained frame rate and bitrate adaptation according to derived per-category QoE models, aimed at maximizing player QoE - **Adaptation approach A** (Section 7.2),
- frame rate adaptation in fixed steps based on achievable bitrate ranges - **Adaptation approach B** (Section 7.3),
- bitrate and frame rate adaptation in fixed steps based on achievable bitrate ranges - **Adaptation approach C** (Section 7.4).

The proposed adaptation approaches differ in how they adjust video frame rate and bitrate

Data: game video traces, cluster centroids, video encoding configuration strategies

Result: appropriate video encoding configuration strategy for a game

cluster-fp, cluster-sp-l, cluster-sp-h;

while *game video traces* **do**

 calculate PFIM, IBS and APM scores for the game video traces;

 standardize PFIM, IBS and APM scores calculate distance of PFIM, IBS and APM scores to cluster centroids;

if *distance closest to Cluster FP centroid* **then**

 cluster-fp++;

else if *distance closest to Cluster SP-L centroid* **then**

 cluster-sp-l++;

else

 cluster-sp-h++;

end

if *cluster-fp = max(cluster-fp, cluster-sp-l, cluster-sp-h)* **then**

 assign Game category FP video encoding adaptation strategy;

else if *cluster-sp-l = max(cluster-fp, cluster-sp-l, cluster-sp-h)* **then**

 assign Game category SP-L video encoding adaptation strategy;

else

 assign Game category SP-H video encoding adaptation strategy;

end

end

Algorithm 1: Algorithm for assigning a new game to derived game categories and choosing appropriate video encoding adaptation strategy for the game

for each of the game categories in light of resource availability constraints. Therefore, *based on a chosen adaptation approach, the concrete adaptation strategies are then further derived*, as shown in Figure 7.1.

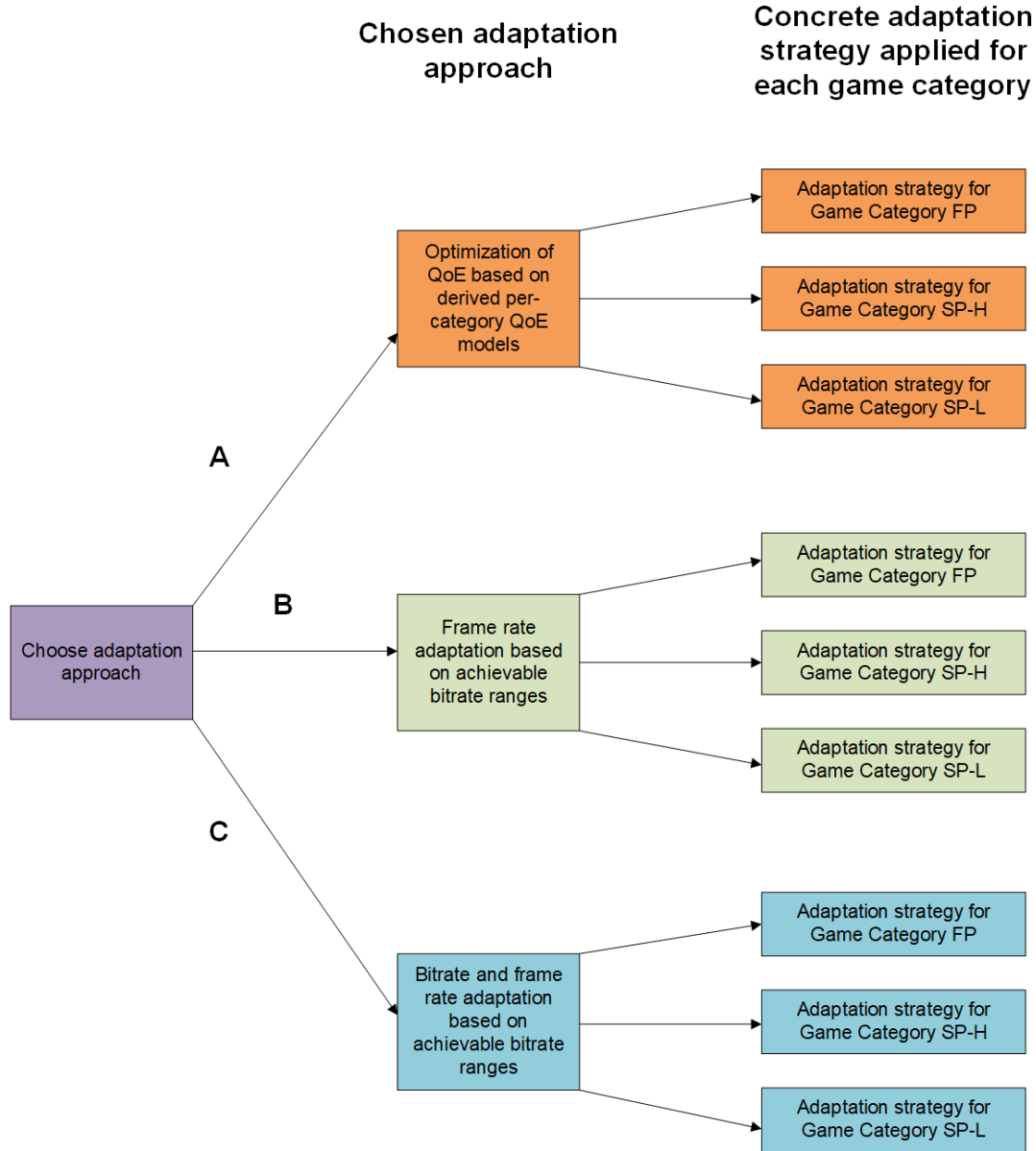

Figure 7.1: Deriving concrete per-game category adaptation strategies based on chosen adaptation approach

The first approach conforms to the derived QoE models and configures video encoding parameters accordingly with available bandwidth changes. From the practical viewpoint of a cloud gaming service provider, frequent switching of frame rate and bitrate values due to variable available bandwidth are likely to be impractical, and possibly have a negative impact on user's perceived QoE [29]. Instead of constant and fine-grained adaptation of frame rate and bitrate, two adaptation approaches are proposed with predefined thresholds at which frame rate and/or bitrate are adapted. The performance of the different proposed adaptation approaches is compared in Chapter 8 with respect to resource allocation and QoE management in the context of multiple players accessing a shared network link.

7.2 Adaptation approach A: optimization of QoE based on derived per-category QoE models

The first proposed adaptation approach, **Adaptation approach A**, strictly follows QoE models for derived game categories, i.e., within each game category video bitrate is set in accordance with available bandwidth, while frame rate is configured so as to maximize QoE for the achievable bitrate according to the QoE model corresponding to that game category. The derived QoE models, described in the previous section, were examined with regards to achieved highest MOS under different bitrate values. Figure 7.2 shows frame rates values for which the highest MOS was achieved under certain bitrate restrictions. Depicted frame rate configurations that conform to derived QoE models for different game categories represent proposed **Adaptation approach A**.

For Game Categories FP and SP-L, the lowest frame rate is 40 fps with an available bitrate of 3 Mbps, and it increases in steps of 1 fps approximately every 0.7 Mbps for Game category FP, and 1 Mbps for Game category SP-L. On the other hand, according to the QoE model for Game category SP-H, frame rate should be kept at 60 fps, regardless of achievable bitrate. Once again two limitations of the conducted user studies should be highlighted. First, **tests covered only video bitrate values in the range of 3-10 Mbps, thus the proposed strategies target only this range**. Furthermore, all studies were conducted using a video resolution of 720p, thus **resolution adaptation is not considered**. Further studies would be needed to specify the frame rate adaptation strategy beyond or below the tested range of achievable bitrates, and also for different resolution levels.

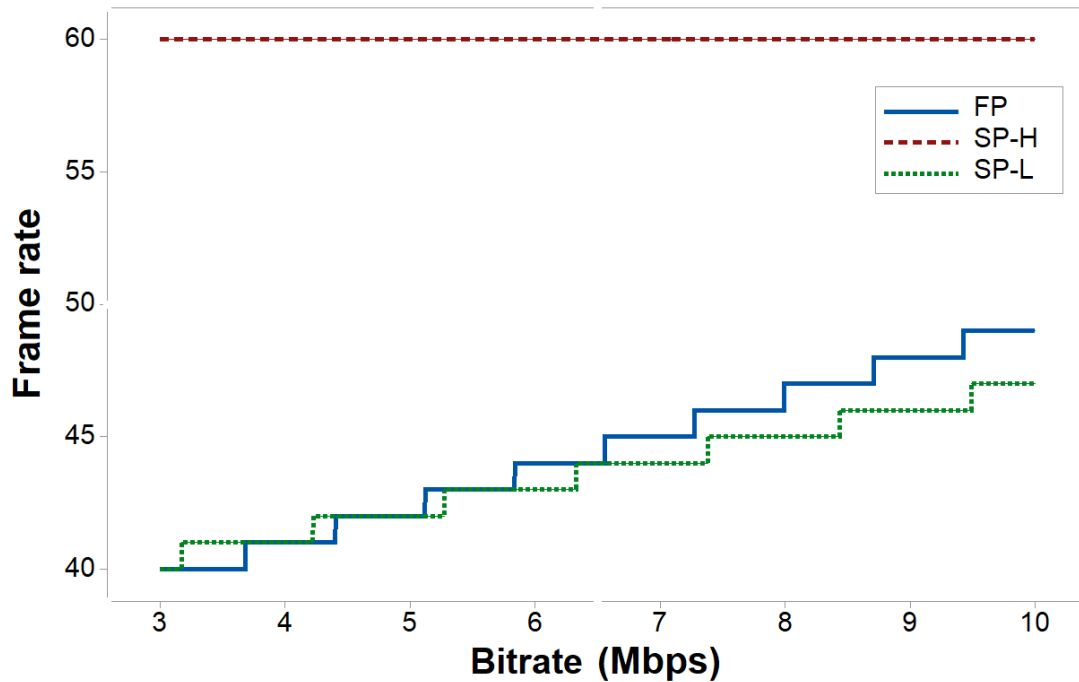

Figure 7.2: Frame rate configurations based on QoE estimation models for the game categories given achievable bitrate and fixed resolution of 720p

7.3 Adaptation approach B: frame rate adaptation based on achievable bitrate ranges

As previously mentioned, the other two proposed adaptation approaches specify thresholds at which bitrate and frame rate values should be adapted. The thresholds were defined considering the bitrate and frame rate levels at which the highest gains of MOS are obtained while increasing available bitrate. To simplify an adaptation procedure for a service provider, minimizing the number of quality switches was one of the main criteria while defining the thresholds. First, an array of estimated MOS values (based on derived QoE models) for bitrate ranging from 3 Mbps to 10 Mbps was examined to find the bitrate levels suitable for thresholds. First, second, and third quartiles of QoE data for derived QoE models were calculated and are shown in Figure 7.3. For Game category SP-H and Game category FP it can be observed that two thresholds could be set at the first and third quartile of the estimated MOS, as the gain of MOS by increasing bitrate to the first quartile is the same as the MOS gain by increasing bitrate from first to third quartile. With regards to Game category SP-L, one threshold is sufficient to perform efficient service adaptation, as there is no drastic gain of MOS with an increase of bitrate, due to users' being satisfied with the service under the given configuration of codec parameters.

Besides examining quartiles for MOS scores, the estimated MOS obtained from QoE models for Game categories FP and SP-L with constant frame rate values was investigated subsequently. As can be observed in Figure 7.4, both FP and SP-L QoE models with 40 fps overlap with

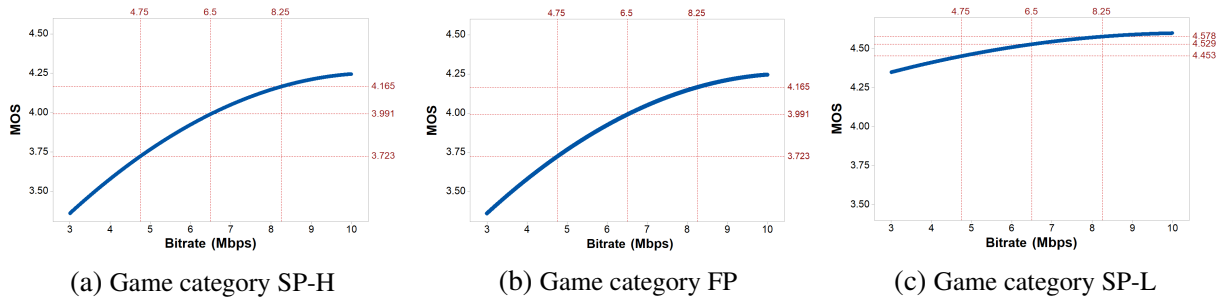

Figure 7.3: Quartiles for MOS scores derived from QoE models for the game categories

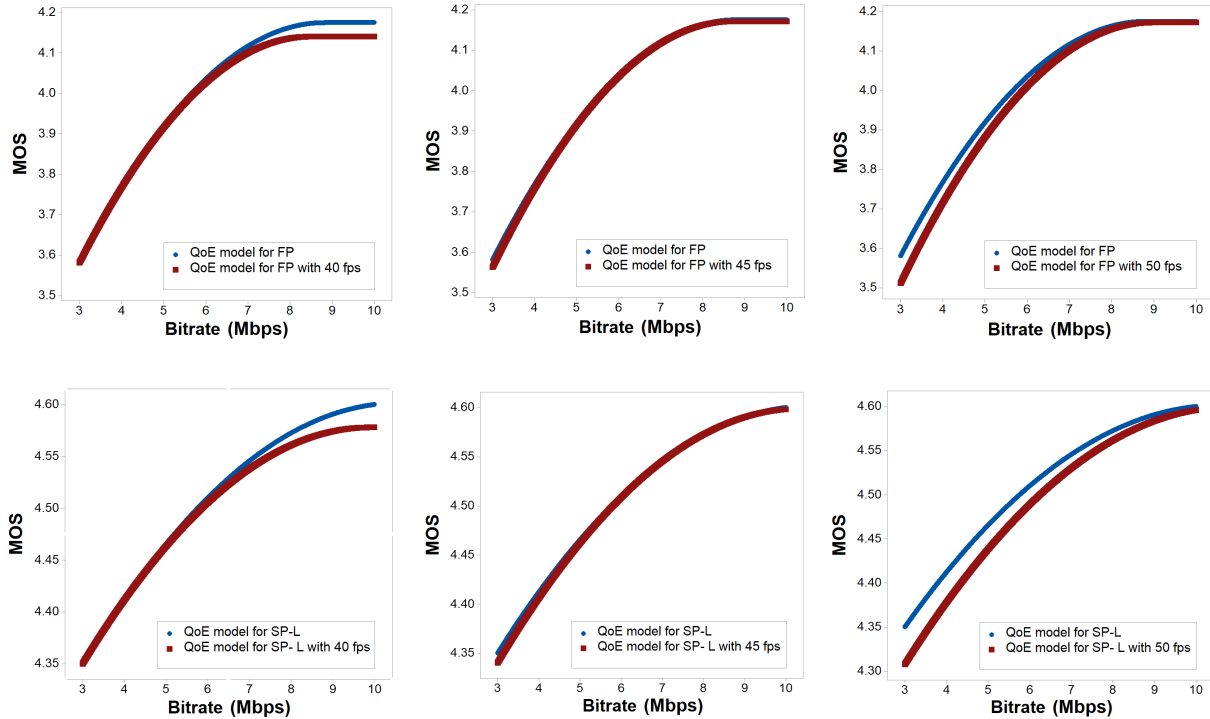

Figure 7.4: MOS for Game categories FP and SP-L derived based on QoE models: MOS as a function of bitrate assuming frame rate adaptation, and compared to MOS values with fixed frame rates

corresponding derived QoE models (that adjust frame rate with bitrate change) until the first threshold at approximately 5 Mbps. The FP QoE model with a fixed 45 fps has roughly the same estimated values as the corresponding QoE model until the second threshold at 8 Mbps, after which the FP QoE model with 50 fps has a better approximation. On the contrary, the SP-L QoE model with a fixed value of 45 fps fairly accurately approximates MOS compared to the QoE model that adjusts frame rate for all bitrates higher than 5 Mbps.

According to the previously performed analysis, proposed **Adaptation approach B** is portrayed in Figure 7.5. Adaptation approach B only performs frame rate adaption, and assumes that video bitrate is set to the maximum achievable values, which in practice depends on the availability of the network bandwidth.

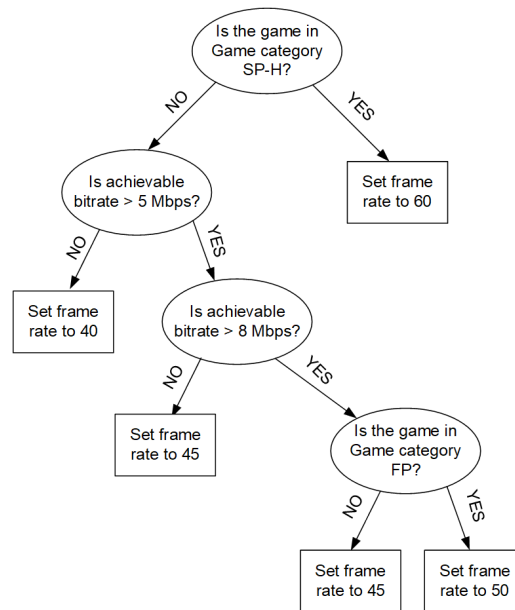

Figure 7.5: Proposed video encoding adaptation approach B: frame rate adaptation defined for different bitrate ranges. The target codec bitrate is set to the maximum achievable bitrate that can be transmitted given network constraints.

7.4 Adaptation approach C: bitrate and frame rate adaptation based on achievable bitrate ranges

Adaptation approaches A and B focus only on maximizing MOS under bandwidth availability constraints, overlooking potentially other important optimization objectives, such as usage of system resources and inherently service costs. For example, if consumption of system resources is considered while performing service adaptation on the server side, Game category SP-L games could keep frame rate values set to 25 fps, as our subjective studies have shown that overall QoE of players will not be significantly reduced as compared to Strategies A and B where fps is adapted. **Adaptation approach C** is an approach that adjusts frame rate and bitrate less frequently compared to previously proposed video encoding adaptation approaches. Figure 7.6 describes Adaptation approach C that further simplifies the adaptation process for a service provider, while also minimizes system and network resources.

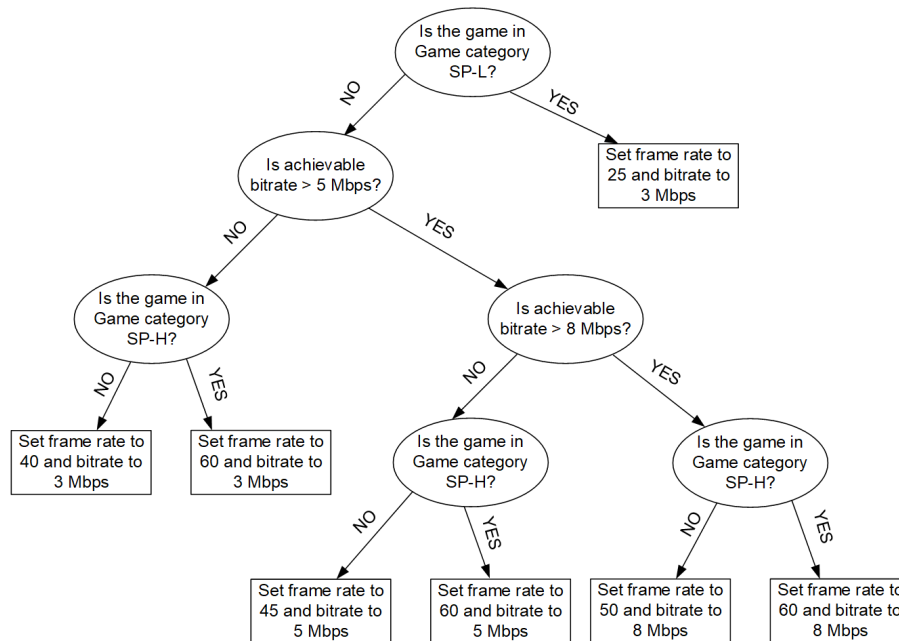

Figure 7.6: Proposed video encoding adaptation approach C: frame rate and bitrate adaptation defined for different bitrate ranges.

Summary of the findings: The following adaptation approaches are proposed:

- Adaptation approach A: video bitrate is set to maximum achievable bitrate, while frame rate is configured to a value that maximizes QoE for assigned bitrate according to the QoE model corresponding to that game category,
- Adaptation approach B: video bitrate is set to maximum achievable bitrate, while frame rate is set according to defined thresholds,
- Adaptation approach C: both bitrate and frame rate set according to defined thresholds based on achievable bitrate ranges.

7.5 Chapter summary

In this chapter video encoding adaptation strategies for cloud gaming are proposed and described in a detail. The derived game categorization in combination with newly derived QoE models was utilized for proposing three novel video encoding adaptation approaches containing different QoE-driven video encoding adaptation strategies that could be exploited by a service provider to perform appropriate service adaptation for different cloud gaming streams. Video encoding adaptation approaches differ in a way they adjust video codec parameters bitrate and frame rate for different types of games in light of resource availability constraints. Performance of proposed adaptation approaches (and assigned QoE-driven video encoding adaptation strategies) is evaluated in a case study reported in the following chapter.

Chapter 8

QoE-aware resource allocation for cloud gaming under variable network resource availability constraints

This chapter describes a numerical case study involving performance evaluation of the video encoding adaptation strategies proposed in the previous chapter. The focus is on investigating how different adaptation approaches in combination with different optimization objectives (in terms of quality and fairness) drive the outcome of adapting multiple simultaneous cloud gaming flows sharing a bottleneck link. A part of the presented results were published in [147].

Section 8.1 describes two different types of service adaptation for cloud gaming. In Section 8.2 an optimization problem for QoE-aware resource allocation is formulated (adopted from [13]), while in Section 8.4 a case study involving the formulated problem is described. In Section 8.3 the resource allocation algorithms used for solving the formulated problem are described, while Section 8.5 reports on the performance of used algorithms compared to the baseline algorithm while utilizing Adaptation approach A. Furthermore, Section 8.6 contains performance evaluation and comparison of proposed Adaptation approaches A, B, and C. To verify if the estimated MOS based on QoE models for game categories is similar to the estimated MOS based on QoE models for an individual game, the performance of these QoE models is evaluated in Section 8.6.3. Finally, Section 8.7 describes evaluation of the impact of parameter θ on video bitrate and MOS distribution in the system.

8.1 QoE-driven service adaptation for cloud gaming

As discussed previously in the thesis, service adaptation for cloud gaming could be performed on the server-side by changing video encoding configuration parameters of a game stream with respect to available network bandwidth (likely estimated at the client) and number of active

players connected to the server. Conducted studies have shown that adaptation strategies should also consider type of played game as a key context parameter. The following subsections describe service adaptation in the following cases: considering only a single player, and considering multiple simultaneous players sharing joint network resources. The later case involving multiple simultaneous users was used in a case study to evaluate performance of the proposed video encoding adaptation strategies.

QoE-driven service adaptation for a single player

The main objective of this simplified case is to maximize player QoE while making efficient use of available resources. In particular, the player is assigned to a cloud gaming server (located in a data center) that is only responsible for a single user. All system (e.g., CPU, GPU) and network resources (available bandwidth on the access link) accessible to the cloud gaming server are intended for the assigned player. The cloud gaming server is not aware of the other servers in the data center (as regards sharing network resources), therefore it adapts the service according to the needs of the assigned player. Consequently, depending on available bandwidth, the server adapts the video encoding configurations to achieve highest possible QoE for the player.

A solution for the given problem of QoE-driven server-side service adaptation for a single player is straightforward and involves finding a combination of frame rate and bitrate for a selected game that achieves the highest MOS score under given constraints. Derived QoE models can be used in estimating MOS for a given combination of video encoding parameters and game type. Since the solution space of the problem is narrow (i.e., feasible set of frame rate and bitrate is relatively small and bounded), a basic approach for solving this problem is to perform exhaustive search of the feasible region.

QoE-driven service adaptation for multiple simultaneous players

In this case, the main objective is to maximize overall players' QoE while making efficient use of available resources. As an example, a single cloud gaming server is considered as being responsible for multiple simultaneous players. All system resources (e.g., CPU, GPU) available on the cloud gaming server are shared between all connected players to the server. Additionally, multiple cloud gaming servers in the data center use the same outgoing data link for sending video game streams, therefore bandwidth is shared between the players connected to the data center, as shown in Figure 8.1. As a result, we identify our aim as being to improve QoE for active gaming session players, considering demands and available resources, achieved by adapting video encoding configurations to network constraints. Derived QoE models can be used to estimate MOS for a given combination of video encoding parameters and game type. Further consideration of constraints with respect to server-side system resources is considered

out of scope and should be addressed in future work.

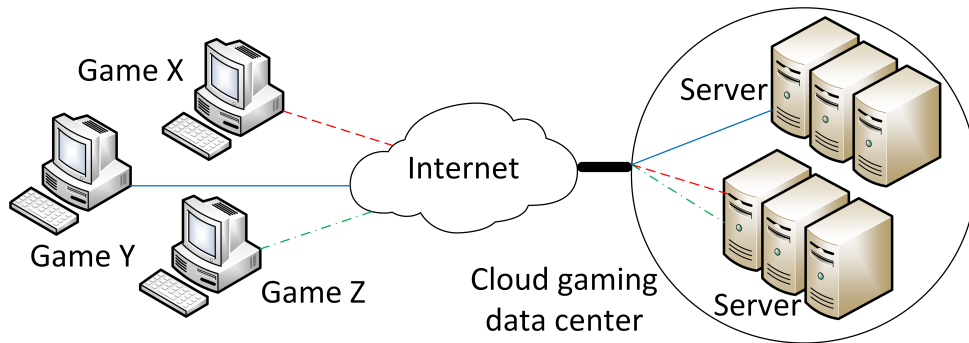

Figure 8.1: Cloud gaming service delivered to multiple users over a shared bottleneck link

8.2 Problem formulation for QoE-aware resource allocation

The notation used in the problem formulation is given in Table 8.1. We formulate the problem as follows. Each player p from all active players N is assigned to a server in a data center and starts playing game g_p (g_p is one of the available games G). The data center uses an outgoing data link for sending video game streams corresponding to all players, and B represents available link bandwidth. We highlight that in our problem formulation and numerical results, **the bandwidth denotes the available resources for video bitrates**, thus ignoring bandwidth usage of lower-layer protocols. Let f_p ($f_{min} \leq f_p \leq f_{max}$) be frame rate and bit_p ($bit_{min} \leq bit_p \leq bit_{max}$) be the bitrate of a game stream for each of the active players. The minimum frame rate f_{min} is set to 25 fps and the maximum frame rate f_{max} to 60 fps, as proposed QoE models (utilized for estimating the QoE scores) are based on subjective QoE studies where frame rate was varied between these two values. Moreover, the maximum frame rate of 60 fps is a typical frame rate that average experienced players consider sufficient without perceiving quality degradations. Likewise, the minimum bitrate bit_{min} is set to 3 Mbps and the maximum bitrate bit_{max} to 10 Mbps, with the same reasoning used as for frame rate. Additionally, the previous empirical tests using the Steam In-Home Streaming service have shown that using video bitrates less than 3 Mbps leads to a video with high visual degradations.

The problem of bitrate and frame rate adaptation for multiple simultaneous cloud gaming users sharing a link was also addressed previously by Hong *et al.* [13]. We note that while Hong *et al.* considered constraints imposed by each client's access network conditions, we adopt a simplified approach whereby we assume that each client is capable of streaming up to the bitrate allocated by the resource allocation algorithm. Further while in [13] the authors address both quality-maximization and quality-fairness objectives, we extend these by incorporating the notion of QoE fairness based on the QoE fairness index proposed in [25]. We further extend

Table 8.1: Used notation in the optimization problem

N	number of players
B	available effective bandwidth
G	available games
g_p	selected game by player p
f_{max}	maximum frame rate (set by administrator)
f_{min}	minimum frame rate (set by administrator)
f_p	target frame rate for player p
bit_{max}	maximum bitrate (set by administrator)
bit_{min}	minimum bitrate (set by administrator)
bit_p	target bitrate for player p
m_{g_p, f_p, bit_p}	the MOS score for game g at frame rate f and bitrate br played by player p

this investigation by considering the impact of different weight factors assigned to the quality and fairness objectives to show the impact on video bitrate and MOS distributions.

Let m_{g_p, f_p, bit_p} be the MOS score for player p while playing game g_p at frame rate f_p and bitrate bit_p . The derived QoE models (and associated adaptation strategies) are used for determining the MOS scores based on the video encoding parameters. The decision variables are frame rate f_p and bitrate bit_p for each player, thus solving the problem corresponds to finding players' video encoding configurations that achieve the highest players' QoE in the system with regards to currently available effective bandwidth.

For this problem, the following objective functions were defined and compared:

- maximize average MOS across all players (*max-avg quality* objective);
- maximize minimal MOS across all players (*max-min quality* objective); and
- maximize a weighted sum of average MOS across all players and fairness (*max-avg quality-fairness* objective).

We utilize the QoE fairness index as proposed in [148, 149], and defined as follows:

$$F = 1 - \frac{2\sigma}{H - L}, \quad (8.1)$$

where σ is the standard deviation of QoE scores, L is the lower bound and H is the upper bound of the used rating scale. The QoE fairness index as a standalone metric does not rate the level of QoE that the service achieves, but rather quantifies achieved QoE fairness (as opposed to QoS fairness) of the system on a scale of [0;1].

Based on the described definitions, the service adaptation problem is formulated as a mathematical problem with the max-avg quality objective function as follows:

$$\max \sum_{p=1}^N m_{g_p, f_p, bit_p} \quad (8.2)$$

$$\text{s.t. } 1 \leq p \leq N \quad (8.3)$$

$$g_p \in G, \forall p \quad (8.4)$$

$$bit_{min} \leq bit_p \leq bit_{max}, \forall p \quad (8.5)$$

$$\sum_{p=1}^N bit_p \leq B \quad (8.6)$$

$$f_{min} \leq f_p \leq f_{max}, \forall p \quad (8.7)$$

For the max-min quality objective, the objective function given in Eq. 8.2 is replaced with

$$\max \min_{p=1}^N m_{g_p, f_p, bit_p}. \quad (8.8)$$

In the case of the max-avg quality-fairness objective, the objective function is formulated as

$$\max((1 - \theta) \sum_{p=1}^N m_{g_p, f_p, bit_p} + \theta F), \quad (8.9)$$

where parameter θ denotes the relevance of QoE fairness in the system as compared to average MOS. It should be noted that in this case MOS scores are normalized, with 1 indicating highest MOS and 0 indicating lowest MOS.

8.3 Algorithm description for solving the formulated problem

For solving the optimization problems, the approach was based on the algorithms proposed in [13] that proved to be efficient in finding the optimal solution to this problem. The basic idea is to first set each player's bitrate to the lowest possible value, and iteratively allocate small chunks of bandwidth (e.g., 100 kbps) to the player with the largest MOS gain. Thereby, for the *max-avg quality* objective problem, additional bandwidth (if available) is allocated in repeated steps to the players for which a gain of added bitrate results with the highest increase of MOS in the system. The pseudocode of the max-avg quality algorithm is shown in Algorithm 2, where \hat{B} denotes the remaining bandwidth on the bottleneck link, w the allocation step, and $c_u(\cdot)$ the quality improvement function.

```

let  $\hat{B} = B$ 
store players in a heap on quality improvement  $c_u(\cdot)$  in the dsc. order
while  $\hat{B} > 0$  do
    pop and remove the player  $u$  with the maximal  $c_u(\cdot)$  from the heap
    if allocating  $bit_p + w$  on  $p$  satisfies (8.6) then
        let  $bit_p = bit_p + w$ 
        let  $\hat{B} = \hat{B} - w$ 
        insert the player  $p$  to the heap
    else
        remove the player  $p$  from the heap
    end
end
return all  $bit_p$ 

```

Algorithm 2: The pseudocode of the max-avg quality algorithm, taken from [13]

Similarly, for the *max-min quality* objective problem, bandwidth is allocated to the player with the lowest MOS score. The pseudocode of the max-min quality algorithm is given in Algorithm 3. For the *quality-fairness* objective problem, the algorithm is the same as for its equivalent quality objective problem (the max-avg quality problem), however fairness in the system is considered while evaluating players' MOS scores during allocation steps. Lastly, chosen algorithms were compared with a *baseline algorithm* that allocates the same amount of bandwidth to all active players, irrespective of game type. The baseline algorithm also does not adapt video frame rate, but rather keeps it constantly at approx. 60 fps, as observed from the default Steam In-Home Streaming resource allocation algorithm.

```

let  $\hat{B} = B$ 
store players in heap on MOS scores  $mos(\cdot)$  in the asc. order
while  $\hat{B} > 0$  do
    pop and remove the player  $u$  with the minimal  $mos(\cdot)$  from the heap
    if allocating  $bit_p + w$  on  $p$  satisfies (8.6) then
        let  $bit_p = bit_p + w$ 
        let  $\hat{B} = \hat{B} - w$ 
        insert the player  $p$  to the heap
    else
        remove the player  $p$  from the heap
    end
end
return all  $bit_p$ 

```

Algorithm 3: The pseudocode of the max-min quality algorithm, taken from [13]

It should be noted that all of these algorithms assume monotonicity of the model functions, i.e., an increase of video bitrate results with a boost in MOS score, which is met by derived QoE models for game categories after saturation correction. In the case of the QoE model for Game category FP, MOS values estimated by the model that go beyond the saturation point are replaced with MOS values at the saturation points so as to maintain monotonicity.

8.4 Description of the case study

The service adaptation problem was solved by defining instances of the problem with various numbers of simultaneous players N in the range between 100 and 400. In each instance, an even distribution of players across game categories was assumed (assuming the three game categories presented in Chapter 6). In the case of a number of players resulting with an uneven distribution, players from the Game categories FP and SP-H were added in the instance. The available effective bandwidth was kept constant throughout the instances and set equal to the amount of bandwidth necessary for providing all players with minimal video bitrate in the instance with the highest number of players (1200 Mbps). As a result, we assume that with 400 players in the system, it would be possible to assign each player the minimal possible video bitrate (i.e., 3 Mbps), while in the case of 100 players, this ensures that it would be possible to allocate the maximum bitrate (up to 10 Mbps) to each of the players.

All defined problem instances were solved utilizing the different adaptation approaches defined in Chapter 7, in combination with different resource allocation algorithms (in terms of different objective functions), so as to compare their performance. The minimum step for adapting the bandwidth allocation in all implemented algorithms is 100 kbps, which we assume to be more appropriate for real-time service adaptation compared to smaller allocation steps, as it reduces the run-time of the algorithms. For the *max-avg fairness-quality* algorithm, parameter θ was set to 0.5 to make the system relatively fair in terms of achieved MOS for the players. We will further investigate the impact of the parameter θ on the resource allocation in Section 8.7. With that in mind, the following metrics were observed: MOS (average and minimum MOS), average allocated bitrate per game, and average allocated frame rate per game. Obtained results are reported in the following sections.

8.5 Performance evaluation of resource allocation algorithms compared to the baseline algorithm

For the purpose of comparing the different resource allocation algorithms and their objective functions, we assume the use of Adaptation approach A for configuring bitrate and frame rate in accordance with allocated bandwidth. The max-avg quality, max-min quality and max-avg fairness-quality algorithms were evaluated in terms of average MOS and bitrate in the system, and compared to the aforementioned baseline algorithm.

First, the distribution of MOS scores in the system was investigated for a single instance of the problem. The distribution of MOS scores for all algorithms in the case of 300 concurrent players (with 100 players per game category) can be observed in Figure 8.2. All three implemented resource allocation algorithms have nearly identical MOS distributions (please note that

their lines in the CDF are overlapping), and show better results as compared to the baseline algorithm. Thus we observe that games in Game categories SP-H and FP achieve higher MOS scores as compared to the baseline, while games in Game category SP-L have the same MOS scores as compared to the baseline algorithm. Additionally, it can be observed that the distribution of MOS scores for users playing games from the same game category is “almost” even, as the algorithms iteratively allocate resources across all players in steps of 100 Kbps such that games from the same game category will for the most part have identical allocated bitrate, and hence MOS (we assume users’ homogeneity in terms of system, user, and context factors impacting user’s MOS). However, if there are not enough resources to equally allocate resources to all players in the same game category, the result would be the occurrence of two groups of players with only slight differences in MOS scores (as observed in Figure 8.2 in the case of Game categories SP-H and FP), thus resulting with “almost” even distribution of MOS scores for players in the same game category.

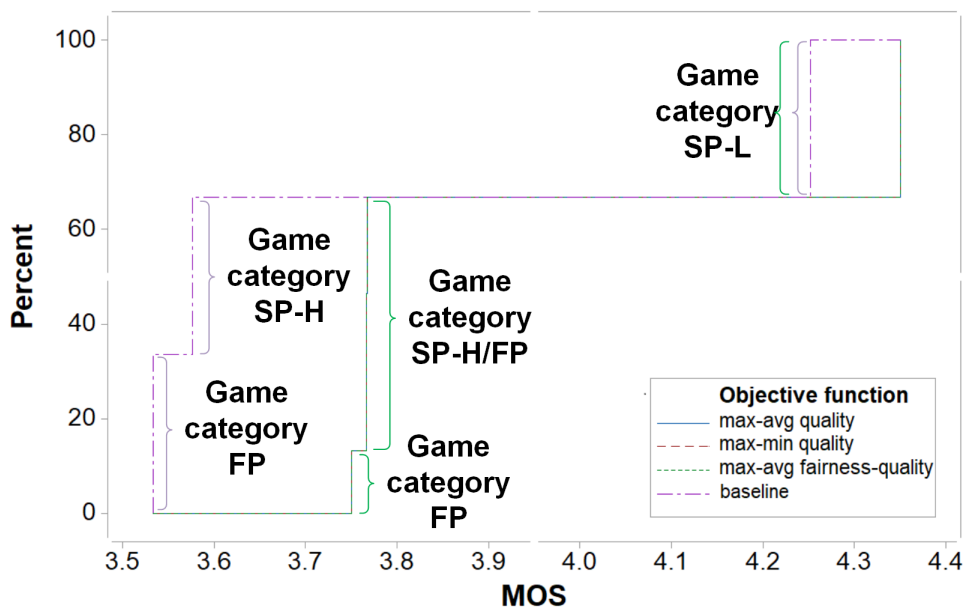

Figure 8.2: CDF of MOS scores for the tested resource allocation algorithms. 300 concurrent players assumed in the system, with 100 per game category.

We further analyze the performance of all tested algorithms as the number of players increases in the system. The aim is to observe the impact of different objective functions on MOS scores and resource allocation. Once again, we assume the use of Adaptation approach A. First, average MOS scores for all problem instances are shown in Figure 8.3. All implemented algorithms achieve higher average MOS compared to the baseline algorithm, and the difference increases as the number of players increases in the system. The max-min quality and max-avg fairness-quality algorithms have a more similar average MOS curve as compared to the other two algorithms (the max-avg quality and baseline algorithms), as both algorithms aim to im-

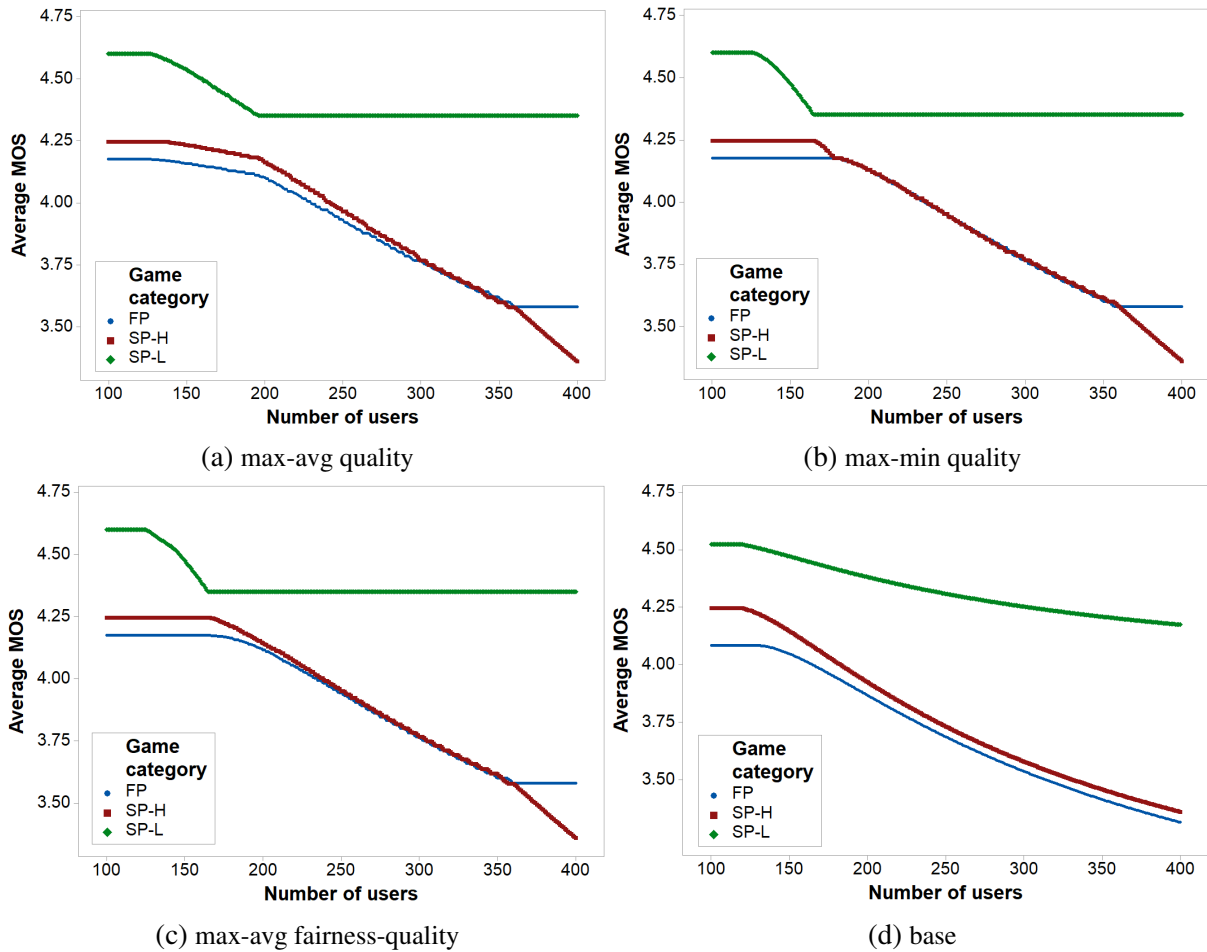

Figure 8.3: Average MOS scores for different numbers of users in the system. Results for four different optimization objectives are portrayed, which determine the amount of resources (bitrate) assigned to each player. Adaptation approach A is assumed for the purpose of mapping MOS to bitrate values.

prove fairness (i.e., trying to decrease the deviation in MOS scores for users in Game categories FP and SP-H), as visible in Figure 8.4. Unlike max-avg and baseline, in the case of insufficient bandwidth in the system, the max-min quality and max-avg fairness-quality algorithms reduce resources allocated to Game category SP-L before assigning less bitrate to the other two game categories. Even with bitrate set to minimum values of 3 Mbps, users in Game category SP-L have higher average MOS scores compared to the other two game categories, consequently resulting with aforementioned resource allocation decision.

When minimum MOS scores are investigated, it can be observed in Figure 8.5 that the results are nearly identical as in the case of average MOS scores. Since the MOS scores for each game category are evenly distributed, there is practically no difference between minimum and average MOS scores. Therefore, minimum MOS scores will not be investigated in further performance analysis of the algorithms and adaptation approaches.

As far as bitrate is concerned, the algorithms that emphasize fairness (the max-min quality and max-avg fairness-quality algorithms) keep bitrate at the highest level for Game categories

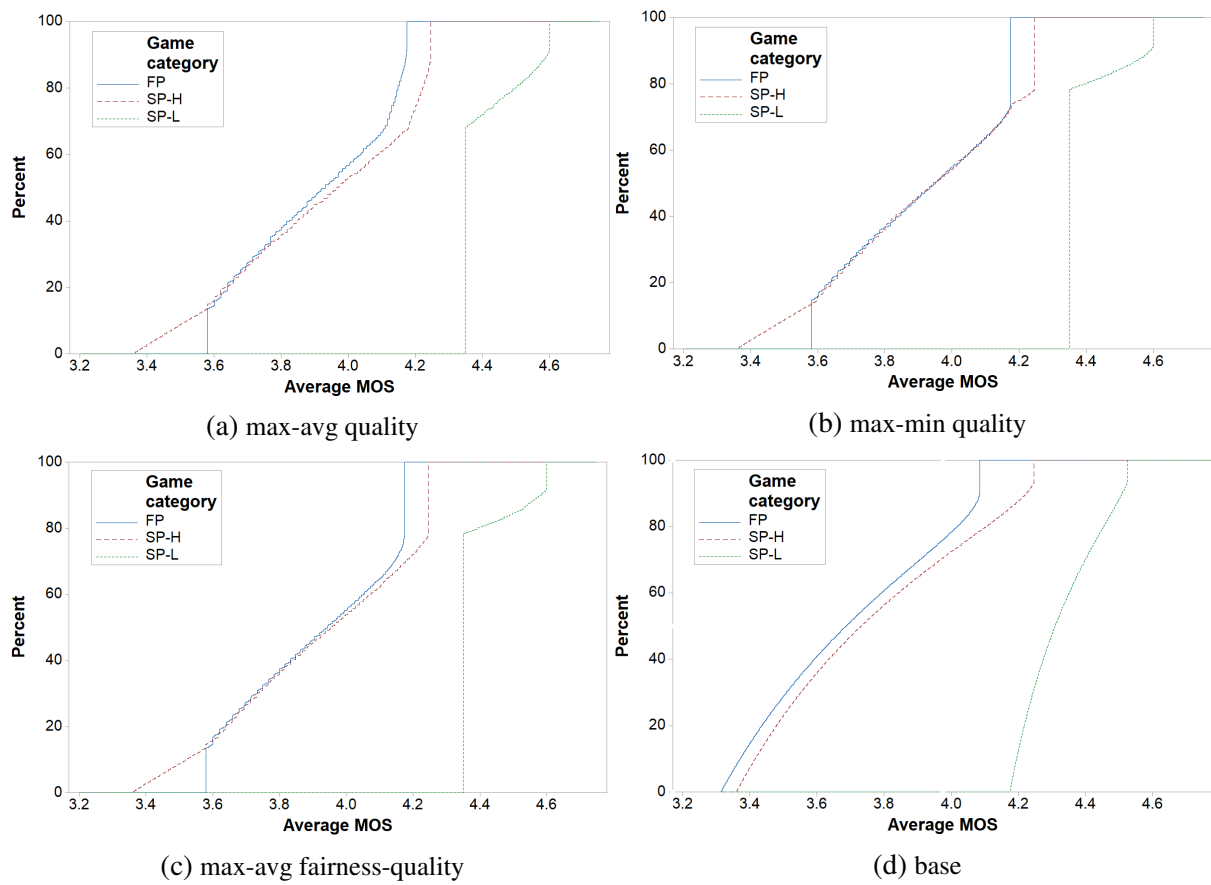

Figure 8.4: Distribution of average MOS scores across scenarios with 100 - 400 users. Distributions portrayed for the four optimization algorithms while utilizing Adaptation approach A.

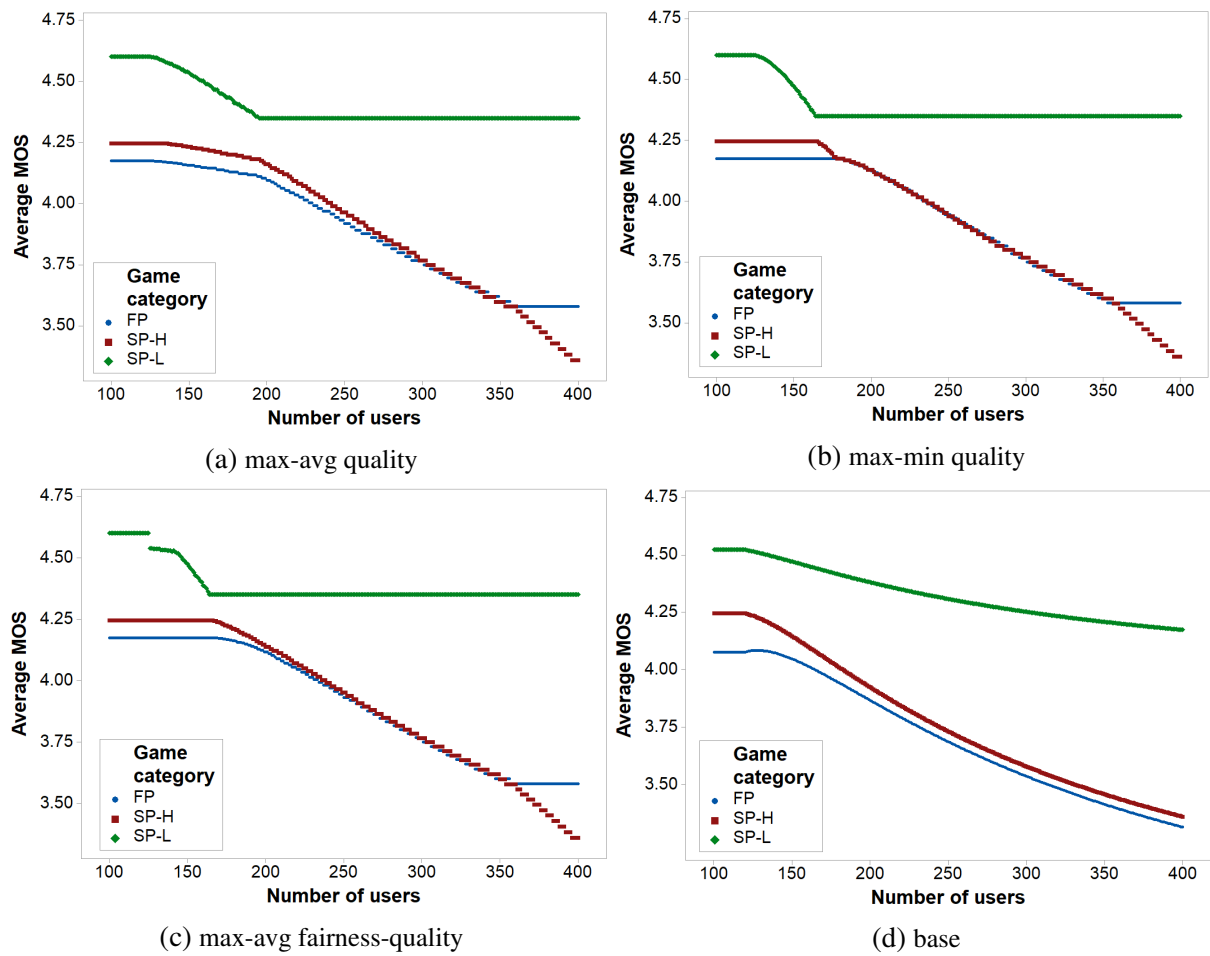

Figure 8.5: Distribution of minimum MOS scores across scenarios with 100 - 400 users. Distributions portrayed for the four optimization algorithms while utilizing Adaptation approach A.

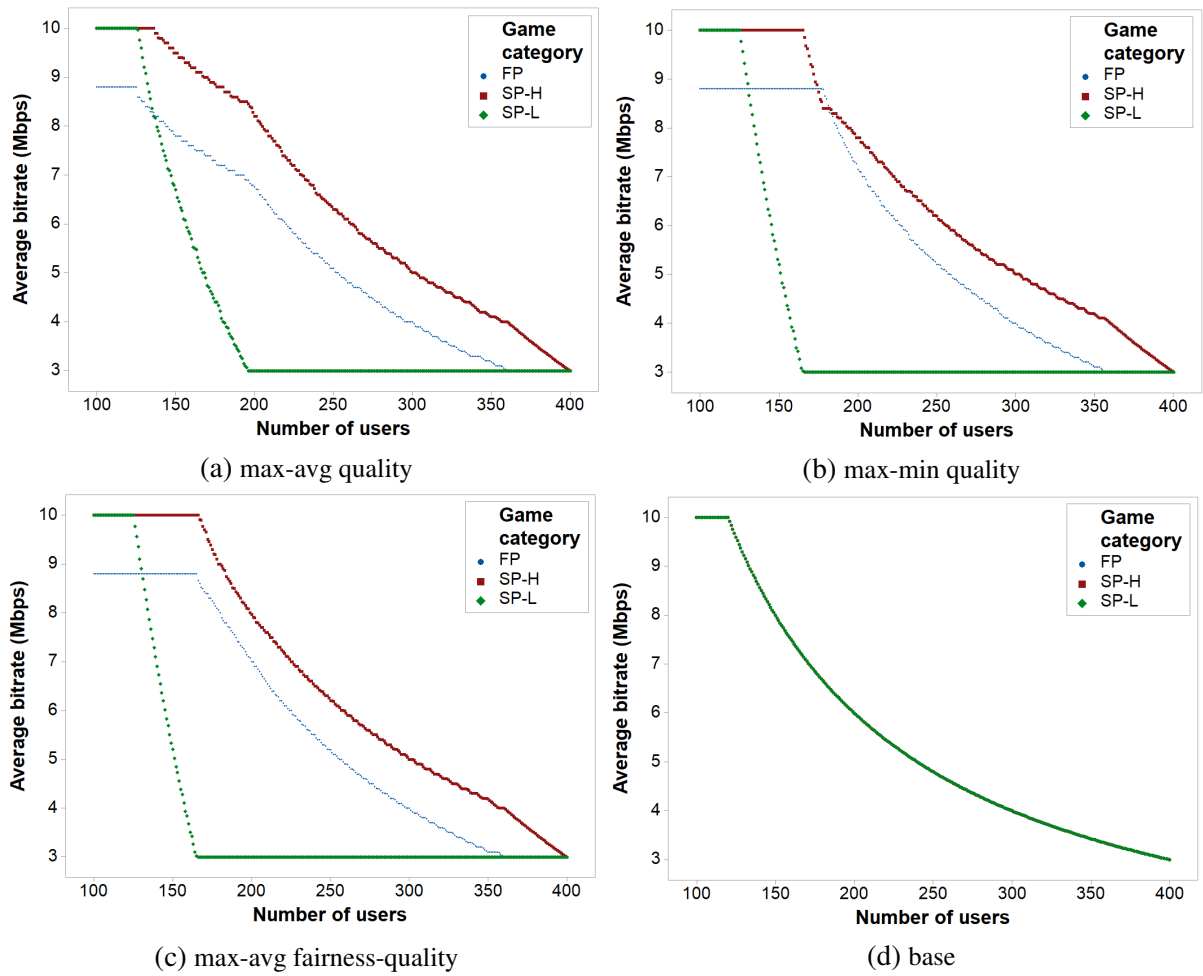

Figure 8.6: Average bitrate for the tested algorithms while utilizing Adaptation approach A

FP and SP-H, as long as it is possible to decrease bitrate for Game category SP-L (shown in Figure 8.6). This is possible as games grouped in Game category SP-L are not as sensitive to bitrate reduction as games in other game categories. Furthermore, as a goal of both these algorithms is to reduce the variance in MOS scores in the system, the difference between allocated bitrate for Game categories FP and SP-H is also reduced (as clearly visible in Figure 8.7). To reduce the gap between these two game categories, the fairness algorithms keep bitrate at high values for Game category FP until it reaches values near the bitrate levels of Game category SP-H. It should be also noted that due to previously mentioned video quality saturation in the case of our QoE model for Game category FP, users playing games in Game category FP are assigned less than the maximum available bitrate, even though there is remaining available bandwidth in the system.

Finally, frame rate allocation is shown in Figure 8.8. The baseline algorithm assigns frame rate equally to each of the game categories, similarly to allocating bitrate. Additionally, the fairness algorithms keep high frame rate values for Game category FP, in line with bitrate allocation described in the previous paragraph.

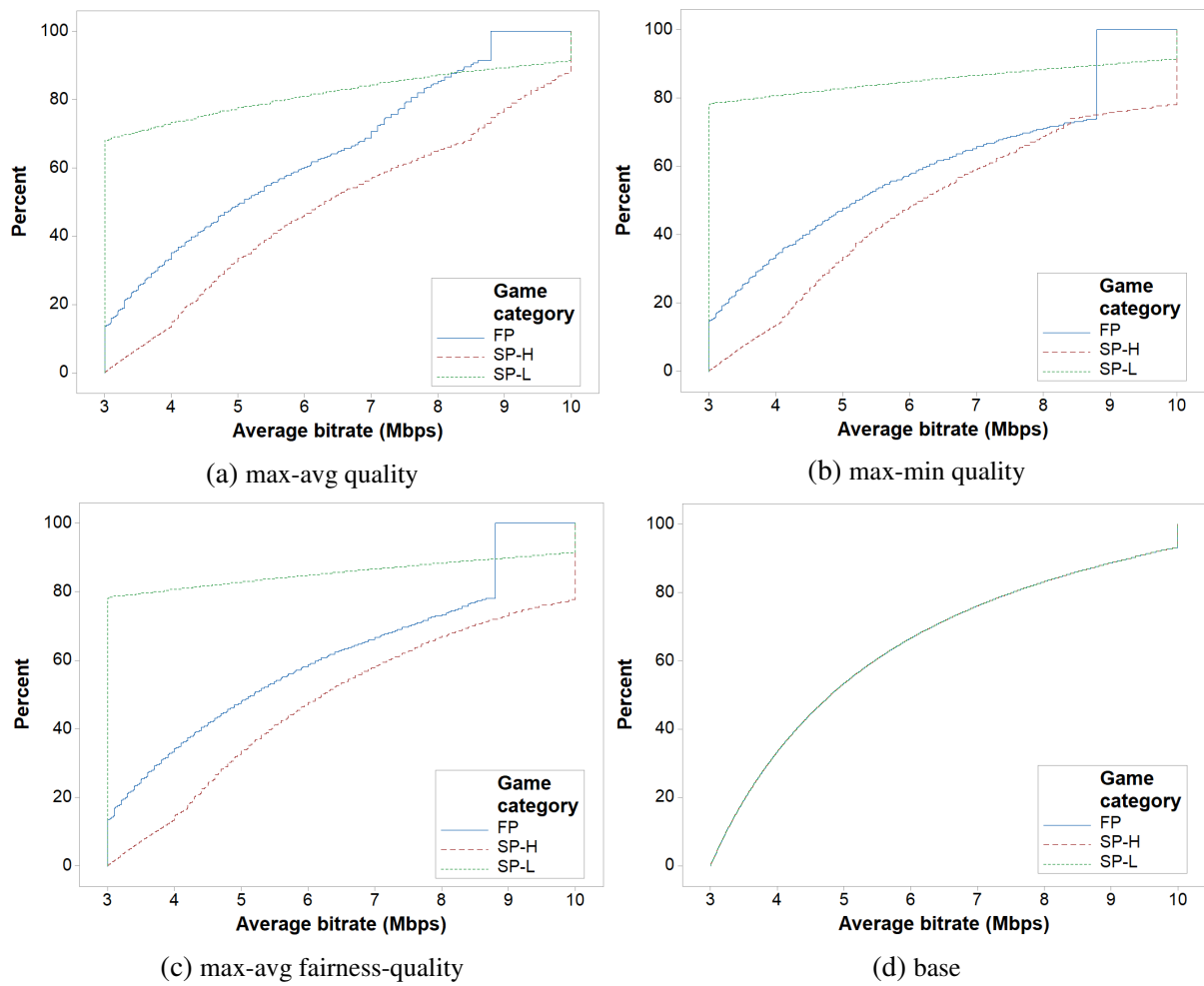

Figure 8.7: Distribution of average bitrate across scenarios with 100 - 400 users. Distributions portrayed for the four optimization algorithms while utilizing Adaptation approach A.

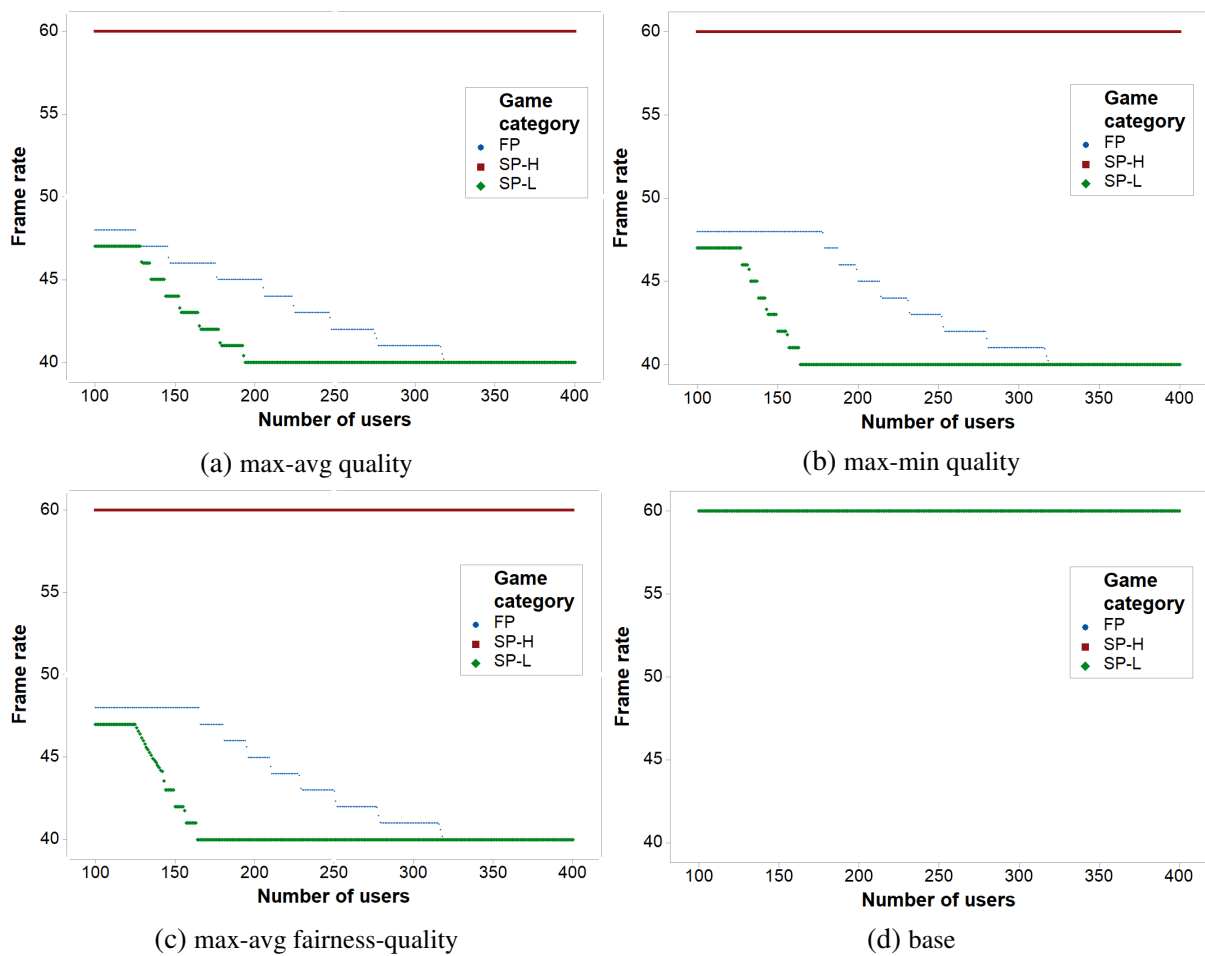

Figure 8.8: Distribution of average frame rate across scenarios with 100 - 400 users. Distributions portrayed for the four optimization algorithms while utilizing Adaptation approach A.

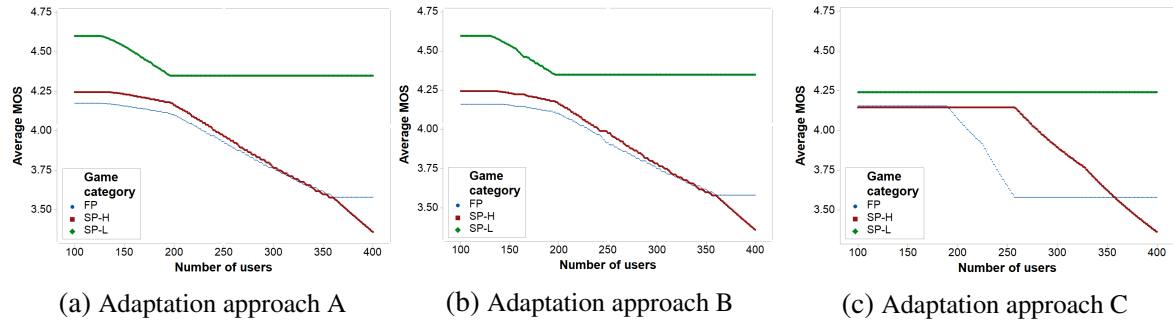

Figure 8.9: Average per-game category MOS scores for Adaptation approaches A, B, and C while utilizing the max-avg quality resource allocation algorithm

8.6 Performance evaluation and comparison of Adaptation approaches A, B, and C

To evaluate the proposed adaptation approaches, their performance was investigated in combination with the max-avg quality and max-min quality algorithms, as max-avg fairness-quality algorithms yielded similar results as the max-min quality algorithm (described in the previous section). Additionally, the baseline algorithm was not considered in the analysis, as Adaptation approach A outperformed the baseline algorithm, and therefore was considered as a reference point for the other two adaptation approaches.

8.6.1 Max-avg quality algorithm

In Figure 8.9 we portray average MOS scores per game categories plotted for different numbers of simultaneous users in the system. The three subgraphs compare results across the three different adaptation approaches, while utilizing the max-avg quality algorithm. Adaptation approaches A and B achieve very similar results, thus proving that strict frame rate adaptation is not mandatory to reach good enough MOS. On the other hand, the results for Adaptation approach C show a drop of average MOS in the system as compared to Adaptation approaches A and B. This is especially visible in the cases when there is an abundance of available bandwidth in the system (up to 200 users). However as the number of users is increased, the performance of Adaptation approach C becomes similar to that of the other two approaches.

The distribution of average MOS scores depicted in Figure 8.10 further shows nearly identical results for Adaptation approaches A and B. In addition to that, it can be observed that users playing games grouped in Game category SP will endure more negative player experience compared to the other two game categories if Adaptation approach C is used in the system. Games in Game category SP are more sensitive to the limited amount of the available bandwidth, while other two game categories achieve better MOS scores in the same conditions.

If we consider allocated bitrate, Adaptation approaches A and B achieve very similar results,

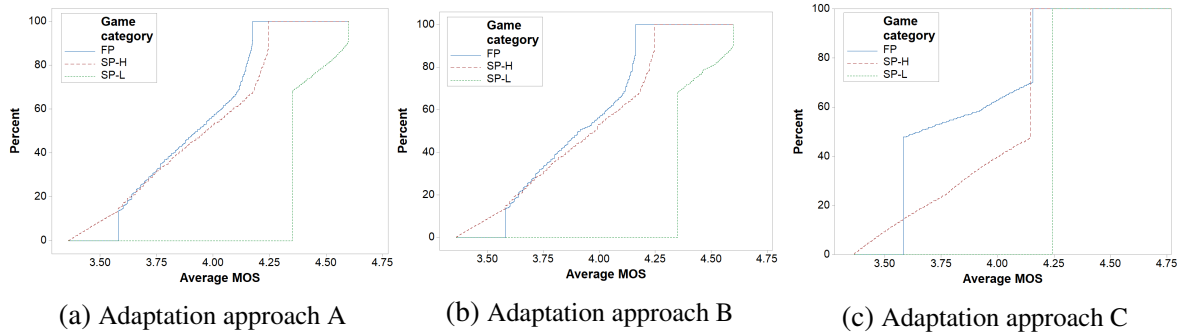

Figure 8.10: Distribution of average per-game category MOS scores for Adaptation approaches A, B, and C while utilizing the max-avg quality resource allocation algorithm

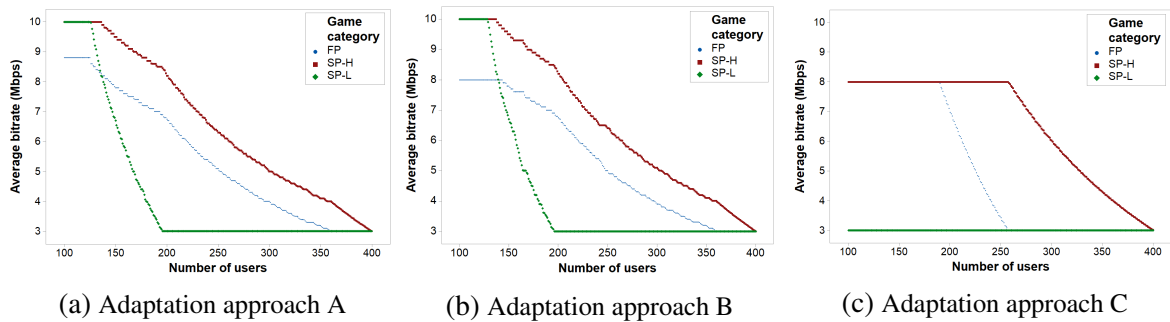

Figure 8.11: Average per-game category bitrate for Adaptation approaches A, B, and C while utilizing the max-avg quality resource allocation algorithm

similar to the results of average MOS. In Figure 8.11 it can be seen that for Adaptation approach B in the case of Game category FP, maximum allocated bitrate per player is 8 Mbps, which is lower than 8.8 Mbps allocated by Adaptation approach A. This is a consequence of quality saturation on a lower bitrate level for the QoE model for Game category FP using Adaptation approach B thresholds. In the case of Adaptation approach C, it can be observed that maintaining a low bitrate of 3 Mbps for Game category SP-L allows other game categories to preserve higher bitrate as the number of players increases in the system. However, for Game category FP, minimal bitrate is achieved near 250 users, while in the case of the other two strategies this occurs only after 360 users are in the system.

With regards to allocated frame rate in the system, it can be seen in Figure 8.12 that all approaches strictly assign frame rate based on the derived QoE models (Adaptation approach A), or defined thresholds (in the case of Adaptation approaches B and C). By reducing frame rate, adaptation approaches are not only achieving higher MOS, but they are minimizing system resources required to render games on the server side, and thus allowing cost savings for the service provider.

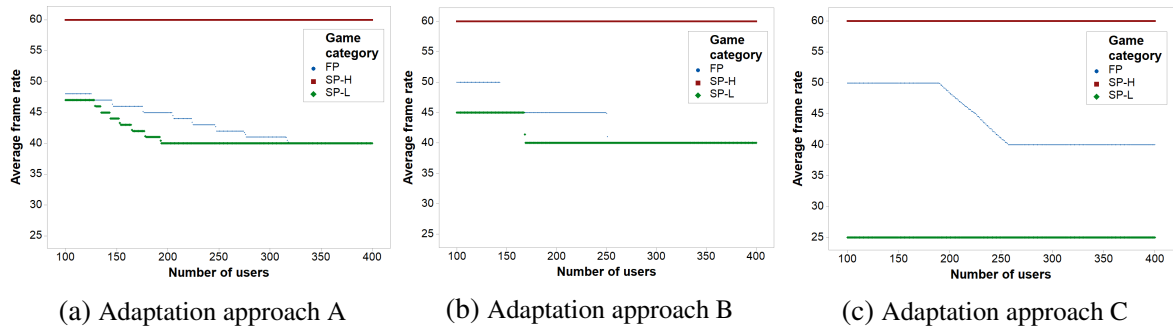

Figure 8.12: Average per-game category frame rate for Adaptation approaches A, B, and C while utilizing the max-avg quality resource allocation algorithm

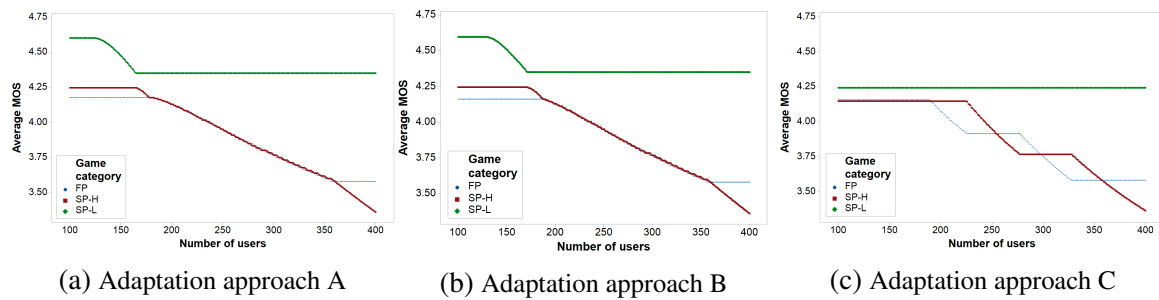

Figure 8.13: Average per-game MOS scores for Adaptation approaches A, B, and C while utilizing the max-min quality resource allocation algorithm

8.6.2 Max-min quality algorithm

In Figure 8.13, average MOS scores for the different adaptation approaches are shown while utilizing the max-min quality algorithm. Adaptation approaches A and B achieve nearly identical results. In both approaches, if there is no extra available bandwidth in the system, the max-min quality algorithm immediately allocates less bitrate to Game category SP-L (to keep minimum MOS for the games in other game categories as high as possible for an extended period of time) until bitrate for all users in Game category SP-L is set to 3 Mbps. This is completely opposite in the case of the max-avg quality algorithm, where the algorithm simultaneously decreases bitrate for all game categories. The results for Adaptation approach C show a drop of average MOS in the system as compared to approaches A and B, which was also observed in the case of the max-avg quality algorithm. Furthermore, it can be seen that for the max-min quality algorithm, a decrease of bitrate for Game category FP and Game category SP-H is alternating (also visible in Figure 8.14, depending on which of the game categories has higher MOS scores at that moment in the system).

If we consider allocated bitrate, Adaptation approach A and B bitrate allocation is very similar, with the only difference being different quality saturation levels for Game category FP (8.8 Mbps vs 8 Mbps) as observed in Figure 8.15. Similarly to the max-avg quality algorithm, in the case of Adaptation approach C, maintaining a low bitrate of 3 Mbps for Game category

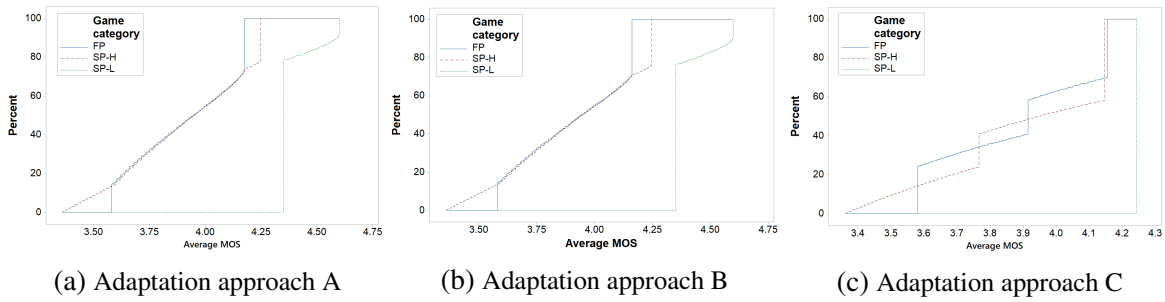

Figure 8.14: Distribution of average per-game category MOS scores Adaptation approaches A, B, and C while utilizing the max-min quality resource allocation algorithm

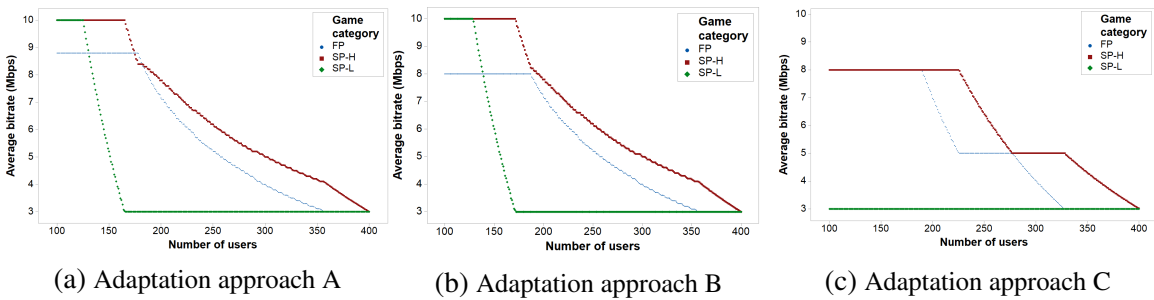

Figure 8.15: Average per-game category bitrate for Adaptation approaches A, B, and C while utilizing the max-min quality resource allocation algorithm

SP-L can be observed at the beginning, resulting with prolonged higher bitrate levels for the other two game categories.

In the case of frame rate allocation, the algorithm performs similar to the max-avg quality algorithm, as it allocates lower frame rate to Game category SP-L in comparison with Game category FP by following QoE models and defined thresholds used in the approaches.

8.6.3 Performance comparison of derived game category QoE models with QoE models for individual games

A further analysis was performed to verify if the estimated MOS based on derived QoE models for game categories (and subsequent proposed adaptation approaches) is equivalent to the

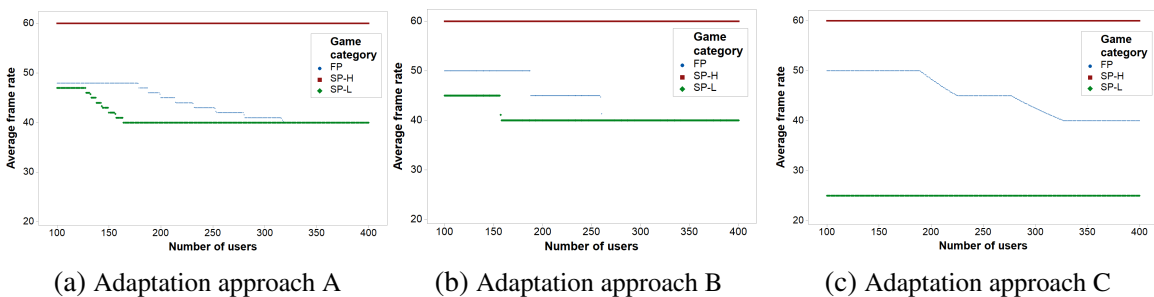

Figure 8.16: Average per-game category frame rate for Adaptation approaches A, B, and C while utilizing the max-min quality resource allocation algorithm

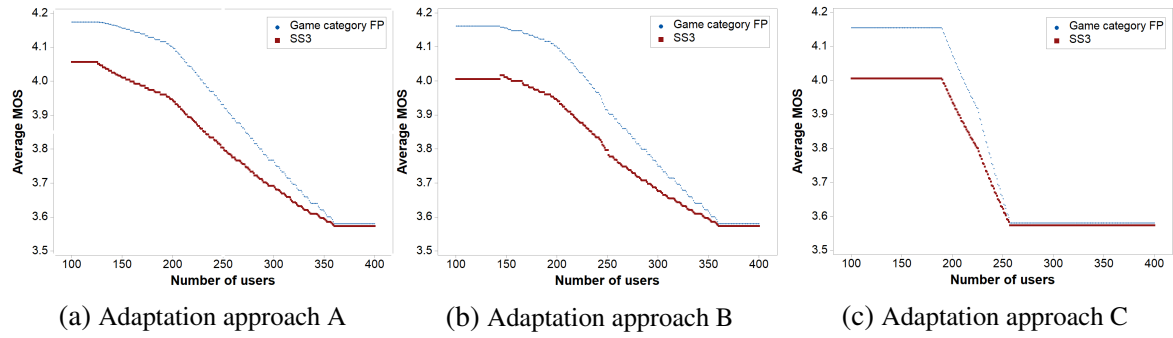

Figure 8.17: Average MOS scores for Game category FP and SS3 for Adaptation approaches A, B, and C while utilizing the max-min quality resource allocation algorithm

estimated MOS based on derived QoE models for individual games. Therefore, we compared average MOS scores for Game category FP with scores for SS3 for each of the adaptation approaches, utilizing the max-avg quality resource allocation algorithm. Average MOS scores for Game category FP are in all three cases slightly higher as compared to SS3 scores, with the gap decreasing as the number of users is rising in the system, as seen in Figure 8.17. In the case of Adaptation approach B, there is a small increase of MOS score for SS3 at around 145 users, as frame rate value at allocated bitrate to SS3 (defined by frame rate thresholds in Adaptation approach B) resulted with an increase in QoE scores for SS3. Even though average MOS scores for Game category FP are not overlapping with scores for SS3, a similar pattern of a gradual change of average MOS can be observed, meaning that bitrate and frame rate allocation has a similar impact on estimated MOS for SS3 as a single game, and for Game category FP. The goal of this analysis was to see to what extent using a per-category QoE model for resource allocation and consequently codec configuration would result in MOS scores that deviate from MOS scores achievable if a per-game QoE model was utilized.

8.7 Performance evaluation of the impact of parameter θ on video bitrate and MOS distribution

Finally, the impact of parameter θ (Equation 8.1) on average/minimum MOS values and bitrate was investigated, thus examining the impact of varying the relevance of fairness as compared to quality maximization in the system. The results show that changing the value of θ has minimal impact on average and minimum MOS scores (this being a result of the QoE models used). However, the parameter adjustment directly impacts the distribution of the allocated bandwidth between players in the system.

The optimization problem was solved with 175 concurrent players (the instance where maximum difference of average MOS was observed) while also adjusting θ from 0 (which results in the max-avg quality objective) to 1 (objective function maximizes fairness with no relevance

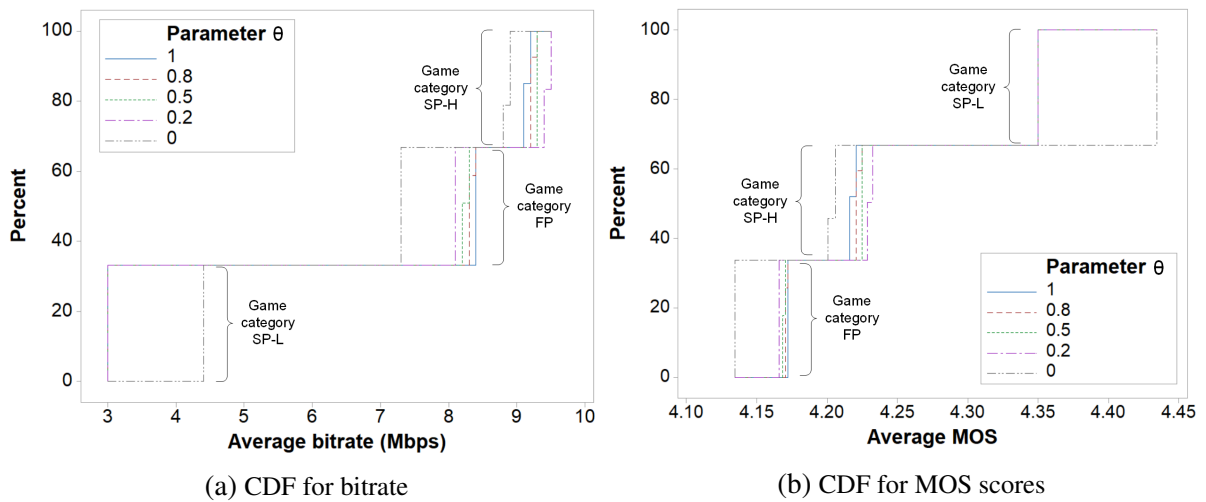

Figure 8.18: CDFs for allocated video bitrates and MOS scores in a scenario with 175 users. Different values of θ illustrate the impact of fairness relevance.

assigned to quality maximization). Even though the impact is minimal in terms of average and minimum MOS scores in the system, the bandwidth distribution is significantly altered between the games, as can be observed in Figure 8.18a, in accordance with the change of MOS scores (Figure 8.18b). With an increase in θ , more bitrate is allocated to the game category with lower gains of MOS per bitrate (Game category FP) by reducing the bitrate previously allocated to the game category with higher gains (Game category SP-H). The algorithm attempts to equalize average MOS score for games in these two game categories to increase fairness in the system, as there is no available bandwidth to increase MOS scores for both game categories. Meanwhile, the bitrate for Game category SP-L gaming sessions always stays at the lowest values (as games grouped in Game category SP-L have significantly higher QoE scores at lowest level compared to QoE scores at highest level for other two game categories), apart from the case when fairness is not considered (θ is equal 0). Even though the QoE aware algorithms have assigned minimal video bitrate for Game category SP-L sessions, the players' QoE is not degraded. However, by doing so, more bitrate can now be allocated to other gaming sessions, thus illustrating the benefit in cases when server-side service adaptation algorithms consider game category QoE models.

8.8 Chapter summary

In this chapter we evaluate the performance of proposed video encoding strategies in a numerical case study involving QoE-aware resource allocation for cloud gaming under variable network resource availability constraints. Numerical results have shown that QoE-aware algorithms utilizing proposed Adaptation approach A achieve higher average MOS scores compared to a baseline algorithm which assigns the same bitrate to all players in the system. Furthermore,

we compare two different algorithms (max-avg quality and max-min quality algorithms) utilizing proposed adaptation approaches, and show that they results in different bitrate distributions as the number of simultaneous users changes in the system. However, Adaptation approaches A and B achieve similar average MOS scores for each of the compared resource allocation algorithms. Additionally, we study the impact of considering QoE fairness in the optimization objective (as opposed to QoS fairness captured by the baseline algorithm). By varying the relevance of QoE fairness in the objective, we see a significant impact on the actual bitrates (resource allocation) allocated across different game sessions. Hence, we conclude that by optimizing a weighted multi-objective function, service providers are able to tune to what extent QoE fairness should be considered.

Chapter 9

Conclusions & future work

In this chapter we summarize the overall conclusions regarding the thesis contributions. Findings with respect to the research questions introduced in Section 1.2 are summarized in Section 9.1. Furthermore, limitations of the thesis and proposed future work is provided in Section 9.2.

9.1 Conclusions

Following a thorough analysis of state of the art work provided in Section 3, five research questions were identified and addressed in the scope of the thesis. Overall conclusions for each of the identified research question are given below.

RQ1: How can the relationship between QoE and selected video encoding parameters (bitrate, frame rate) be quantified for cloud gaming?

To address this research question, initial users studies were conducted in a laboratory environment to investigate the impact of different video encoding parameters (Chapter 5) and network conditions (Chapter 4) on QoE for cloud gaming. The main goal of the user studies was to investigate how and to what extent video encoding parameters affect perceived QoE for each of the tested games under variable bandwidth availability. With regards to the studies investigating the impact of network parameters on user's QoE, the results of studies have shown that widespread use of cloud gaming is possible if adequate video and gameplay quality is guaranteed during streaming (Section 4.1), however at the time of the studies were conducted, the commercial cloud gaming service GFN utilized a service adaption strategy that in some cases resulted with severe QoE degradations (described in Section 4.2). With respect to the impact of video encoding parameters player QoE, the results of Study 3 (Section 5.1) have shown that bitrate and frame rate reduction has different impact on user's QoE between tested games. However, while differences exist, gameplay smoothness has a more significant impact on QoE for both investigated games then graphics quality under low bandwidth availability constraints. To

see if that is valid for other games, additional users studies were conducted to address this issue.

RQ2: How should video encoding parameters of the game video stream be adapted (or re-configured) in light of decreased bandwidth availability, so as to maximize QoE?

Study S4 (5.2) was subsequently conducted to further investigate the impact of video encoding parameters on the player QoE for cloud gaming. The results have shown that the game type clearly needs to be taken into account when evaluating the QoE for cloud gaming, as derived QoE models for tested games were significantly different. Furthermore, the results also indicate that there is no linear relationship between frame rate and QoE - in some cases it is better to deliver higher frame rate at low bitrates, as shown in Study S3 (Section 5.1), while sometimes is better to deliver lower frame rate and increase graphics quality, as shown in Study S4 (Section 5.2). The results indicated a need to further investigate the impact of different video encoding parameters on other different games.

RQ3: Can the same video encoding parameters (in terms of bitrate and frame rate), derived so as to maximize QoE in light of bandwidth constraints, be assigned to games belonging to different genres (according to existing game categorizations)?

Study S5 (5.3.1) built upon the results of Studies S3 and S4 by investigating the impact of video encoding parameters on player's QoE for a new game. It confirmed results from Study S4, as manipulation of frame rate could be utilized for achieving higher QoE levels under low network bandwidth availability, as in some cases graphics quality increase at the cost of game play smoothness leads to higher user's QoE. As the tested games in Study S5 were games from different game genres (according to existing game categorizations), the results indicate that existing game categorizations are not necessarily suitable for differentiating game types with a goal of optimizing users' QoE for cloud gaming, as the same video encoding adaptation strategy could be applied for games in different game categories. Therefore, the overall conclusion of the first three research questions was that there is a need for a novel categorization of games beyond those typically used for QoE-aware resource allocation for cloud gaming.

RQ4: Is it possible to objectively categorize games based on application-level metrics such that the same video encoding adaptation strategy (in terms of configuring bitrate and frame rate so as to maximize QoE) can be assigned for all games in the same category in light of decreased bandwidth availability?

Given that the need for different video encoding adaptation strategies for different games was identified, an analysis of objective game characteristics (intensity of user actions, video metrics) was conducted to identify game aspects which can be used to quantitatively identify the

differences between video streams of different games in cloud gaming (Sections 6.1 and 6.2). Based on the analyzed objective video and gameplay characteristics, a cluster analysis was performed by using k-means clustering. An initial cluster analysis grouped games into 2 clusters characterized by objective video metrics (IBS, PFIM). However, an additional QoE study conducted in the next phase (Study S6 described in Section 5.3.4) showed the need to extend the proposed categorization, as tested games that were grouped in the same category were empirically found to have different QoE requirements. As a result, the objective game categorization was re-defined, and the intensity of user actions (APM) was considered as an additional metric in the clustering process, finally resulting in three clusters (corresponding to game categories). Furthermore, QoE models for derived game categories were obtained based on the previously collected overall QoE scores during QoE studies (Section 7.1). The derived game categorization in combination with newly derived QoE models was utilized for proposing three novel video encoding adaptation approaches (Sections 7.2, 7.3, and 7.4) containing different QoE-driven video encoding adaptation strategies that could be exploited by a service provider to perform appropriate service adaptation for different cloud gaming streams. Video encoding adaptation approaches differ in the way they adjust video codec parameters bitrate and frame rate for different types of games in light of resource availability constraints.

RQ5: Can the assigned video encoding adaptation strategies for derived game categories be utilized for maximizing QoE and fairness among players sharing a common network bottleneck link?

To address the final research question, performance of proposed adaptation approaches (and assigned QoE-driven video encoding adaptation strategies) was evaluated in a case study involving QoE-aware resource allocation for cloud gaming under variable network resource availability constraints. The results have shown that QoE-aware algorithms utilizing proposed Adaptation approach A achieve higher average MOS scores compared to a baseline algorithm. Furthermore, two different algorithms (max-avg quality and max-min quality algorithms) were compared utilizing proposed adaptation approaches, and showed that they exhibit different bitrate distributions, even though the average MOS scores for each of the compared algorithms were similar. Additionally, the impact of considering QoE fairness in the optimization objective (as opposed to QoS fairness captured by the baseline algorithm) was investigated. By varying the relevance of QoE fairness in the objective, a significant impact on the resource allocation across different game sessions was observed. Hence, by optimizing a weighted multi-objective function, service providers are able to tune to what extent QoE fairness should be considered.

9.2 Limitations and future work

9.2.1 Implications of different resolutions on the results

In all reported subjective studies in this thesis that investigated the impact of video encoding parameters on user's QoE tested game were played at a fixed 720p resolution. At the time the first studies were conducted, commercial cloud gaming platforms also streamed video content at 720p [38]. Furthermore, the laboratory equipment (in terms of used PC hardware as cloud gaming servers) did not meet hardware requirements to play, encode, and stream tested games in 1080p at constant 60 fps, which further facilitated our decision to test games at lower resolution. Additionally, to play tested games at higher resolution (1080p) would result with an increase of bandwidth requirements (evidently showed by the recommended bandwidth of 20-25 Mbps identified by existing cloud gaming services for streaming at 1080p). This would consequently lead to a increase in the number of tested conditions in QoE studies, which, given the length of the studies, would result with a narrowing down of scope for the other tested parameters (frame rate) or a change of test methodology. Even though our conducted subjective studies were limited to 720p resolution, an important contribution of the thesis is the proposed methodology used for obtaining game categories, deriving QoE models for the obtained categories, and proposing video encoding adaptation strategies for cloud gaming. Future QoE studies should also consider higher resolutions (1080p, 4k), and investigate the impact of video resolution on user Qoe, in addition to bitrate and frame rate.

9.2.2 Implications of different codecs on the results

At the time of studies were conducted, all tested gaming platforms utilized H.264 codec for encoding the game content that was streamed to the client devices. Therefore, it should be noted that QoE models and video encoding adaptation strategies were derived based on performance of the H.264 codec, thus other newer video codecs (such as H.265/HEVC and VP9) are out of the scope of this thesis. In order to propose video encoding adaptation strategies for other codecs, their performance should be investigated by conducting additional subjective studies, using the same methodology presented in the thesis. Additionally, new gameplay video traces should be recorded and analyzed to inspect if the temporal and spatial characteristics differ from video traces collected in the thesis.

9.2.3 Improvement of derived QoE models

The video encoding adaptation strategies proposed in the thesis are based on the QoE models derived from the collected data on player QoE while manipulating video encoding parameters

(bitrate, frame rate) and game type. To further improve the accuracy of derived QoE models, some of the following could be considered for the future work:

- incorporate video resolution into the models as one of the video encoding parameters that impacts QoE,
- incorporate network parameters (e.g., latency, packet loss) into the models,
- investigate the impact, and incorporate user (e.g., experience, motivation) and context factors into the models (e.g., social context, gaming cost),
- evaluate perceived QoE by measuring psychophysical stimuli and using more complex questionnaires to estimate user satisfaction with the service.

9.2.4 Limitations of the game categorization

With regards to the proposed game categorization, in future work we would like to collect additional gameplay video traces for cloud gaming and validate the clustering results using the obtained data. Furthermore, including more input data (such as camera position, graphics style, and gameplay complexity) to the cluster analysis could possibly refine and improve the clustering results. Also, additional cluster analysis techniques could be applied and its results be compared to the reported results in the thesis.

9.2.5 Limitations of the service adaptation problem

The performance of the proposed video encoding adaptation strategies was evaluated in the case study of QoE-aware resource allocation for cloud gaming under variable network resource availability constraints. However, several limitations should be considered addressed in the future work. In the case study we assumed users' homogeneity in terms of system, user, and context factors impacting user ratings. Future work could consider integrating into the existing service adaptation problem different access network conditions for the users, different client devices, and different human influence factors impacting users' QoE for cloud gaming. Additionally, different service payment models could be also incorporated to further diversify users in the system. Furthermore, the case study could be implemented as a simulation in which some of the aforementioned factors alter as the simulation time progresses. Finally, we must note that the main focus was on investigating if the video encoding adaptation strategies could be applied in a beneficial way. The execution time of utilized algorithms was investigated in study [13], and the results have shown the possibility of using the algorithms in real-time scenarios. With regards to the max-avg fairness-quality algorithm, we note that the algorithm is slower compared to the algorithms reported in study [13], thus a heuristic method for examining the impact of QoE fairness in the system should be considered.

9.2.6 The future of cloud gaming

As the largest gaming and technological companies have grasped the prospect of cloud gaming and clearly see it as a service that will revolutionize the gaming market, it is becoming highly unlikely that cloud gaming will cease to be present on the market, contrary to belief present at the time OnLive shut down. Companies such as NVIDIA, Google, and Microsoft are intensely working on securing the means to deliver a high quality gaming experience via cloud gaming technology. Furthermore, simultaneously with the rise of cloud gaming, virtual reality (VR) technology is considered to be an important emerging use case in the context of 5G network rollouts. While a few years ago such advanced technologies as cloud gaming and networked VR were considered unavailable to the general public, nowadays such high-bandwidth low-latency services are expected to achieve market penetration. Combining these technologies has led to *VR cloud gaming*, first announced at the beginning of 2020 by Shadow [150]. Combining VR and cloud gaming would undoubtedly result with a unique gaming experience, however to address combined service requirements is a challenging task, and at the time of finishing this thesis, a new unexplored research area.

Bibliography

- [1] Flexera, “Rightscale 2019 State of the Cloud Report From Flexera”, Tech. Rep., 2019, Available at: <https://resources.flexera.com/web/media/documents/rightscale-2019-state-of-the-cloud-report-from-flexera.pdf>
- [2] Research Cosmos, “Cloud Computing Market Size, Growth Rate Forecast (2019 - 2025)”, Tech. Rep., Oct. 2019, Available at: <https://www.researchcosmos.com/reports/cloud-computing-market/92916729>
- [3] Cai, W., Shea, R., Huang, C.-Y., Chen, K.-T., Liu, J., Leung, V. C., Hsu, C.-H., “A survey on cloud gaming: Future of computer games”, IEEE Access, Vol. 4, 2016, pp. 7605–7620.
- [4] Technavio, “Cloud Gaming Market by Platform, Type, and Geography - Forecast and Analysis 2020-2024”, Tech. Rep., Dec. 2019, Available at: <https://www.technavio.com/report/cloud-gaming-market-industry-analysis>
- [5] “PlayStation Now”, <https://www.playstation.com/en-us/explore/playstation-now/>, [accessed 29.08.2019.].
- [6] “GeForce NOW”, <https://shield.nvidia.com/game-streaming-with-geforce-now/>, [accessed 05.03.2016.].
- [7] “Stadia”, <https://stadia.dev/>, [accessed 29.08.2019.].
- [8] Newzoo, “2019 Global Games Market Report”, Tech. Rep., 2019, Available at: <https://newzoo.com/insights/articles/the-global-games-market-will-generate-152-1-billion-in-2019-as-the-u-s-overtakes-china-as-the-big>
- [9] “Remote Play”, <https://www.playstation.com/en-gb/explore/ps4/features/remote-play/>, [accessed 20.09.2020.].
- [10] “Steam Remote Play”, <http://store.steampowered.com/streaming/>, [accessed 28.08.2019.].

- [11] Suznjevic, M., Dobrijevic, O., Matijasevic, M., “MMORPG player actions: Network performance, session patterns and latency requirements analysis”, *Multimedia Tools and Applications*, Vol. 45, No. 1-3, 2009, pp. 191-241.
- [12] Suznjevic, M., Beyer, J., Skorin-Kapov, L., Moller, S., Sorsa, N., “Towards understanding the relationship between game type and network traffic for cloud gaming”, 2014, p. 6.
- [13] Hong, H.-J., Hsu, C.-F., Tsai, T.-H., Huang, C.-Y., Chen, K.-T., Hsu, C.-H., “Enabling Adaptive Cloud Gaming in an Open-Source Cloud Gaming Platform”, *IEEE Transactions on Circuits and Systems for Video Technology*, Vol. PP, No. 99, 2015, pp. 1-14.
- [14] Slivar, I., Suznjevic, M., Skorin-Kapov, L., “The Impact of Video Encoding Parameters and Game Type on QoE for Cloud Gaming: A Case Study using the Steam Platform”, in *7th International Workshop on Quality of Multimedia Experience (QoMEX)*, May 2015, pp. 1-6.
- [15] Slivar, I., Skorin-Kapov, L., Suznjevic, M., “Cloud Gaming QoE Models for Deriving Video Encoding Adaptation Strategies”, in *Proceedings of the 7th International Conference on Multimedia Systems*, 2016, pp. 1–12.
- [16] Claypool, M., Claypool, K., “Perspectives, frame rates and resolutions: it’s all in the game”, in *Proceedings of the 4th International Conference on Foundations of Digital Games*. ACM, 2009, pp. 42–49.
- [17] Zadtootaghaj, S., Schmidt, S., Barman, N., Möller, S., Martini, M. G., “A classification of video games based on game characteristics linked to video coding complexity”, in *2018 16th Annual Workshop on Network and Systems Support for Games (NetGames)*. IEEE, 2018, pp. 1–6.
- [18] Wang, S., Dey, S., “Modeling and characterizing user experience in a cloud server based mobile gaming approach”, in *Global Telecommunications Conference, GLOBECOM*. IEEE, 2009, pp. 1–7.
- [19] Lee, Y.-T., Chen, K.-T., Su, H.-I., Lei, C.-L., “Are All Games Equally Cloud-gaming-friendly?: An Electromyographic Approach”, in *Proc. of the 11th Annual Ws on Network and Systems Support for Games*, ser. *NetGames ’12*, 2012, pp. 3:1–3:6.
- [20] Möller, S., Pommer, D., Beyer, J., Rake-Revelant, J., “Factors influencing gaming QoE: Lessons learned from the evaluation of cloud gaming services”, in *Proceedings of the 4th International Workshop on Perceptual Quality of Systems (PQS 2013)*, 2013, pp. 1–5.

- [21] Suznjevic, M., Skorin-Kapov, L., Matijasevic, M., “Impact of User, System, and Context factors on Gaming QoE: a Case Study Involving MMORPGs”, in Proc. of the 12th ACM SIGCOMM Workshop on Network and System Support for Games, 2013.
- [22] Jarschel, M., Schlosser, D., Scheuring, S., Hossfeld, T., “An evaluation of qoe in cloud gaming based on subjective tests”, in Innovative Mobile and Internet Services in Ubiquitous Computing (IMIS), 2011 Fifth International Conference on, 2011, pp. 330-335.
- [23] Clincy, V., Wilgor, B., “Subjective Evaluation of Latency and Packet Loss in a Cloud-Based Game”, in 10th Intl. Conf. on Information Technology: New Generations (ITNG). IEEE, 2013, pp. 473–476.
- [24] Quax, P., Beznosyk, A., Vanmontfort, W., Marx, R., Lamotte, W., “An evaluation of the impact of game genre on user experience in cloud gaming”, in Games Innov. Conf. (IGIC), IEEE Intl., 2013, pp. 216–221.
- [25] Slivar, I., Suznjevic, M., Skorin-Kapov, L., Matijasevic, M., “Empirical QoE Study of In-home Streaming of Online Games”, in 13th Annual Workshop on Network and Systems Support for Games, 2014, pp. 1-6.
- [26] Claypool, M., Finkel, D., “The effects of latency on player performance in cloud-based games”, in Proc. of 13th NetGames, 2014, pp. 1–6.
- [27] Wen, Z.-Y., Hsiao, H.-F., “QoE-driven performance analysis of cloud gaming services”, in 16th Intl. Ws. on Multimedia Signal Processing (MMSP). IEEE, 2014, pp. 1–6.
- [28] Liu, Y., Wang, S., Dey, S., “Content-aware modeling and enhancing user experience in cloud mobile rendering and streaming.”, IEEE J. Emerg. Sel. Topics Circuits Syst., Vol. 4, No. 1, 2014, pp. 43–56.
- [29] Suznjevic, M., Slivar, I., Skorin-Kapov, L., “Analysis and QoE Evaluation of Cloud Gaming Service Adaptation under Different Network Conditions: The Case of NVIDIA GeForce NOW”, in 8th International Conference on Quality Of Multimedia Experience (QoMEX). IEEE, 2016, pp. 1–6.
- [30] Schmidt, S., Zadtootaghaj, S., Möller, S., “Towards the delay sensitivity of games: There is more than genres”, in Proc. of 9th QoMEX, May 2017, pp. 1-6.
- [31] Li, Z., Melvin, H., Bruzgiene, R., Pocta, P., Skorin-Kapov, L., Zgank, A., Lag Compensation for First-Person Shooter Games in Cloud Gaming. Cham: Springer International Publishing, 2018, pp. 104–127.

- [32] Sabet, S. S., Schmidt, S., Griwodz, C., Möller, S., “Towards the impact of gamers’ adaptation to delay variation on gaming quality of experience”, in 2019 Eleventh International Conference on Quality of Multimedia Experience (QoMEX). IEEE, 2019, pp. 1–6.
- [33] Claypool, M., Claypool, K., “Latency and player actions in online games”, *Commun. ACM*, Vol. 49, No. 11, Nov. 2006, pp. 40–45, Available at: <http://doi.acm.org/10.1145/1167838.1167860>
- [34] Zadtootaghaj, S., Schmidt, S., Möller, S., “Modeling gaming qoe: Towards the impact of frame rate and bit rate on cloud gaming”, in 10th Intl. Conf. on Quality of Multimedia Experience (QoMEX), 2018.
- [35] Slivar, I., Suznjivic, M., Skorin-Kapov, L., “Game Categorization for Deriving QoE-driven Video Encoding Configuration Strategies for Cloud Gaming”, *ACM Transactions on Multimedia Computing, Communications, and Applications (TOMM)*, Vol. 14, No. 3s, 2018, pp. 1–24.
- [36] Quadrio, G., Bujari, A., Palazzi, C. E., Ronzani, D., Maggiorini, D., Ripamonti, L. A., “Network analysis of the sony remote play system”, in 2016 IEEE Symposium on Computers and Communication (ISCC). IEEE, 2016, pp. 10–13.
- [37] Mok, R. K., Luo, X., Chan, E. W., Chang, R. K., “Qdash: a qoe-aware dash system”, in *Proceedings of the 3rd Multimedia Systems Conference*, 2012, pp. 11–22.
- [38] Manzano, M., Uruena, M., Sužnjević, M., Calle, E., Hernandez, J. A., Matijasevic, M., “Dissecting the protocol and network traffic of the onlive cloud gaming platform”, *Multimedia Systems*, Vol. 20, No. 5, 2014, pp. 451–470.
- [39] Shea, R., Liu, J., Ngai, E. C. H., Cui, Y., “Cloud gaming: architecture and performance”, *IEEE Network*, Vol. 27, No. 4, 2013.
- [40] Ojala, A., Tyrvaainen, P., “Developing cloud business models: A case study on cloud gaming”, *IEEE software*, Vol. 28, No. 4, 2011, pp. 42–47.
- [41] Huang, C.-Y., Chen, K.-T., Chen, D.-Y., Hsu, H.-J., Hsu, C.-H., “Gaminganywhere: The first open source cloud gaming system”, *ACM Transactions on Multimedia Computing, Communications, and Applications (TOMM)*, Vol. 10, No. 1s, 2014, pp. 1–25.
- [42] Dick, M., Wellnitz, O., Wolf, L., “Analysis of factors affecting players’ performance and perception in multiplayer games”, in *Proc. of 4th ACM SIGCOMM workshop on Network and system support for games*, ser. NetGames, 2005, pp. 1–7.

- [43] Koumaras, H., Skianis, C., Gardikis, G., Kourtis, A., “Analysis of h. 264 video encoded traffic”, in Proceedings of the 5th International Network Conference (INC2005), 2005, pp. 441–448.
- [44] Doggen, J., Van der Schueren, F., “Design and simulation of a h. 264 avc video streaming model”, in European Conference on the Use of Modern Information and Communication Technologies, ECUMICT, 2008, p. 160.
- [45] Jarschel, M., Schlosser, D., Scheuring, S., Hoßfeld, T., “Gaming in the clouds: QoE and the users’ perspective”, Mathematical and Computer Modelling, Vol. 57, No. 11, 2013, pp. 2883–2894.
- [46] H.264, I.-T. R., “Advanced video coding for generic audiovisual services”, June 2019.
- [47] encoding.com, “2019 global media format report”, 2019.
- [48] H.265, I.-T. R., “H.265: High efficiency video coding”, November 2019.
- [49] Parsec, “An Introduction To Video Compression”, Tech. Rep., 2018, Available at: <https://blog.parsecgaming.com/an-introduction-to-video-compression-c5061a5d075e>
- [50] Parsec, “A Networking Protocol Built For Low Latency Interactive Game Streaming”, Tech. Rep., 2017, Available at: <https://blog.parsecgaming.com/a-networking-protocol-built-for-the-lowest-latency-interactive-game-streaming-1fd5a03a6007>
- [51] Eurogamer, “The biggest game installs: can anything top Final Fantasy 15’s 148GB on PC?”, <https://www.eurogamer.net/articles/2018-03-12-the-biggest-game-installs-can-anything-top-final-fantasy-15s-148gb-on-pc>, [accessed 28.08.2019.]. March 2018.
- [52] Soliman, O., Rezgui, A., Soliman, H., Manea, N., “Mobile cloud gaming: Issues and challenges”, in International Conference on Mobile Web and Information Systems. Springer, 2013, pp. 121–128.
- [53] “GeForce NOW requirements”, <https://www.nvidia.com/en-us/geforce-now/system-reqs/>, [accessed 20.09.2020.].
- [54] “The OnLive Game Service”, <http://www.onlive.com/>, [accessed 28.08.2019.].
- [55] “Gaikai”, <https://www.gaikai.com/>, [accessed 04.06.2014.].
- [56] “Parsec”, <https://parsecgaming.com/>, [accessed 12.08.2020.].
- [57] “Vortex”, <https://vortex.gg/>, [accessed 10.08.2020.].

- [58] “Remotr”, <http://remotrapp.com/>, [accessed 11.08.2020.].
- [59] “Xbox Game Pass cloud gaming”, <https://www.xbox.com/en-US/xbox-game-pass/cloud-gaming>, [accessed 10.08.2020.].
- [60] “GeForce NOW”, <https://www.nvidia.com/en-eu/geforce-now/#geforcenow/>, [accessed 20.09.2020.].
- [61] “Rainway”, <https://rainway.com/>, [accessed 11.08.2020.].
- [62] “Project Atlas”, <https://www.ea.com/news/announcing-project-atlas>, [accessed 29.08.2019.].
- [63] “Shadow”, <https://shadow.tech/>, [accessed 29.08.2019.].
- [64] “NVIDIA’s GameStream”, <https://www.nvidia.com/en-us/support/gamestream/>, [accessed 20.09.2020.].
- [65] Manzano, M., Urueña, M., Sužnjević, M., Calle, E., Hernández, J., Matijasevic, M., “Dissecting the protocol and network traffic of the OnLive cloud gaming platform”, *Multimedia Systems*, 2014, pp. 1–20.
- [66] VentureBeat, “OnLive will shut down its cloud gaming services and sell assets to Sony”, <https://venturebeat.com/2015/04/02/onlive-will-shut-cloud-gaming-services-and-sell-assets-to-sony/>, [accessed 28.08.2019.]. April 2015.
- [67] Quadrio, G., Bujari, A., Palazzi, C. E., Ronzani, D., Maggiorini, D., Ripamonti, L. A., “Network analysis of the steam in-home streaming game system: poster”, in *Proceedings of the 22nd Annual International Conference on Mobile Computing and Networking*, 2016, pp. 475–476.
- [68] “OMEN Game Stream”, <https://www8.hp.com/my/en/campaigns/gamingpcs/omen-game-stream.html>, [accessed 12.08.2020.].
- [69] “WebRTC”, <https://webrtc.org/>, [accessed 11.08.2020.].
- [70] IGN, “Everything We Know About Stadia: Price, Release Date, Games, Tech Specs, Requirements”, <https://www.ign.com/articles/2019/06/06/stadia-price-release-date-games-tech-specs-requirements-pro-launch-reveal>, [accessed 29.08.2019.]. April 2015.

- [71] PCMag, “Hands On With EA’s Project Atlas Cloud Gaming Service”, Tech. Rep., 2019, Available at: <https://www.pcmag.com/news/hands-on-with-eas-project-atlas-cloud-gaming-service>
- [72] Van Moorsel, A., “Metrics for the internet age: Quality of experience and quality of business”, in Fifth International Workshop on Performability Modeling of Computer and Communication Systems, Arbeitsberichte des Instituts für Informatik, Universität Erlangen-Nürnberg, Germany, Vol. 34, No. 13. Citeseer, 2001, pp. 26–31.
- [73] ITU-T Recommendation, G., “Vocabulary for performance and quality of service”, 2006.
- [74] ETSI, “Human Factors (HF); Quality of Experience (QoE) requirements for real-time communication services”, 2010.
- [75] Le Callet, P., Möller, S., Perkis, A. *et al.*, “Qualinet white paper on definitions of quality of experience”, European network on quality of experience in multimedia systems and services (COST Action IC 1003), Vol. 3, No. 2012, 2012.
- [76] ITU-T Recommendation, E., “Recommendation ITU-T E.800 - Terms and Definitions Related to Quality of Service and Network Performance Including Dependability”, 1994.
- [77] Schatz, R., Hoßfeld, T., Janowski, L., Egger, S., “From packets to people: quality of experience as a new measurement challenge”, in Data traffic monitoring and analysis. Springer, 2013, pp. 219–263.
- [78] Wu, W., Arefin, A., Rivas, R., Nahrstedt, K., Sheppard, R., Yang, Z., “Quality of experience in distributed interactive multimedia environments: toward a theoretical framework”, in Proceedings of the 17th ACM international conference on Multimedia. ACM, 2009, pp. 481–490.
- [79] Batteram, H., Damm, G., Mukhopadhyay, A., Philippart, L., Odysseos, R., Urrutia-Valdés, C., “Delivering quality of experience in multimedia networks”, Bell Labs Technical Journal, Vol. 15, No. 1, 2010, pp. 175–193.
- [80] De Moor, K., Ketyko, I., Joseph, W., Deryckere, T., De Marez, L., Martens, L., Verleye, G., “Proposed framework for evaluating quality of experience in a mobile, testbed-oriented living lab setting”, Mobile Networks and Applications, Vol. 15, No. 3, 2010, pp. 378–391.
- [81] Schatz, R., Egger, S., Platzer, A., “Poor, good enough or even better? bridging the gap between acceptability and qoe of mobile broadband data services”, in 2011 IEEE International Conference on Communications (ICC). IEEE, 2011, pp. 1–6.

- [82] Laghari, K. U. R., Connelly, K., “Toward total quality of experience: A qoe model in a communication ecosystem”, *IEEE Communications Magazine*, Vol. 50, No. 4, 2012, pp. 58–65.
- [83] Varela, M., Skorin-Kapov, L., Ebrahimi, T., “Quality of service versus quality of experience”, in *Quality of experience*. Springer, 2014, pp. 85–96.
- [84] ITU-T - G.1011, “Recommendation ITU-T G.1011 - Reference guide to quality of experience assessment methodologies”, 2013.
- [85] Chen, K.-T., Wu, C.-C., Chang, Y.-C., Lei, C.-L., “A crowdsorceable qoe evaluation framework for multimedia content”, in *Proceedings of the 17th ACM international conference on Multimedia*. ACM, 2009, pp. 491–500.
- [86] Gardlo, B., Ries, M., Hossfeld, T., “Impact of screening technique on crowdsourcing qoe assessments”, in *Radioelektronika (RADIOELEKTRONIKA)*, 2012 22nd International Conference. IEEE, 2012, pp. 1–4.
- [87] Hossfeld, T., Keimel, C., Hirth, M., Gardlo, B., Habigt, J., Diepold, K., Tran-Gia, P., “Best practices for qoe crowdtesting: Qoe assessment with crowdsourcing”, *IEEE Transactions on Multimedia*, Vol. 16, No. 2, 2013, pp. 541–558.
- [88] Hoßfeld, T., Keimel, C., “Crowdsourcing in qoe evaluation”, in *Quality of experience*. Springer, 2014, pp. 315–327.
- [89] Union, I., “Itu-t recommendation p. 800.1: Mean opinion score (mos) terminology”, International Telecommunication Union, Tech. Rep, 2006.
- [90] Hoßfeld, T., Heegaard, P. E., Varela, M., Möller, S., “Qoe beyond the mos: an in-depth look at qoe via better metrics and their relation to mos”, *Quality and User Experience*, Vol. 1, No. 1, 2016, p. 2.
- [91] Hoßfeld, T., Schatz, R., Egger, S., “Sos: The mos is not enough!”, in *Quality of Multimedia Experience (QoMEX)*, 2011 Third International Workshop on. IEEE, 2011, pp. 131–136.
- [92] ITU-T - G.1080, “Recommendation ITU-T G.1080 - Quality of experience requirements for IPTV services”, 2008.
- [93] Moller, S., Engelbrecht, K.-P., Kuhnel, C., Wechsung, I., Weiss, B., “A taxonomy of quality of service and quality of experience of multimodal human-machine interaction”, in *Quality of Multimedia Experience*, 2009. QoMEx 2009. International Workshop on. IEEE, 2009, pp. 7–12.

- [94] Möller, S., Schmidt, S., Beyer, J., “Gaming Taxonomy: An Overview of Concepts and Evaluation Methods for Computer Gaming QoE”, in International Workshop on Quality of Multimedia Experience, QoMEX, Jul. 2013, pp. 1-6.
- [95] Möller, S., Pommer, D., Beyer, J., Rake-Revelant, J., “Factors Influencing Gaming QoE: Lessons Learned from the Evaluation of Cloud Gaming Services”, in Proceedings of the 4th International Workshop on Perceptual Quality of Systems (PQS 2013), Sep. 2013, pp. 1-5.
- [96] Verdejo, A. J., De Moor, K., Ketyko, I., Nielsen, K. T., Vanattenhoven, J., De Pessemier, T., Joseph, W., Martens, L., De Marez, L., “Qoe estimation of a location-based mobile game using on-body sensors and qos-related data”, in 2010 IFIP Wireless Days. IEEE, 2010, pp. 1–5.
- [97] Beyer, J., Miruchna, V., Möller, S., “Assessing the impact of display size, game type, and usage context on mobile gaming qoe”, in 2014 Sixth International Workshop on Quality of Multimedia Experience (QoMEX). IEEE, 2014, pp. 69–70.
- [98] Ijsselsteijn, W., de Kort, Y., Poels, K., Jurgelionis, A., Bellotti, F., “Characterising and measuring user experiences in digital games”, in International conference on advances in computer entertainment technology, Vol. 2, 2007, p. 27.
- [99] Zander, S., Armitage, G., “Empirically measuring the qos sensitivity of interactive online game players”, in Proceedings of the Australian Telecommunications Networks Applications Conference 2004 (ATNAC2004), 2004, pp. 511–518.
- [100] Kusunose, Y., Ishibashi, Y., Fukushima, N., Sugawara, S., “Qoe assessment in networked air hockey game with haptic media”, in 2010 9th Annual Workshop on Network and Systems Support for Games. IEEE, 2010, pp. 1–2.
- [101] Suznjevic, M., Skorin-Kapov, L., Matijasevic, M., “The Impact of User, System, and Context factors on Gaming QoE: a Case Study Involving MMORPGs”, in The 12th Annual Workshop on Network and Systems Support for Games, 2013.
- [102] Ries, M., Svoboda, P., Rupp, M., “Empirical study of subjective quality for massive multiplayer games”, in Systems, Signals and Image Processing, 2008. IWSSIP 2008. 15th International Conference on, june 2008, pp. 181 -184.
- [103] Suznjevic, M., Skorin-Kapov, L., Cerekovic, A., Matijasevic, M., “How to measure and model qoe for networked games?”, Multimedia Systems, Vol. 25, No. 4, 2019, pp. 395–420.

- [104] Robert, A., “Experiential modes of game play”, in *Situated Play*. The University of Tokyo, September 2007.
- [105] Nacke, L., Lindley, C. A., “Flow and immersion in first-person shooters: measuring the player’s gameplay experience”, in *Proceedings of the 2008 Conference on Future Play: Research, Play, Share*. ACM, 2008, pp. 81–88.
- [106] Howard, E., Cooper, C., Wittie, M. P., Swinford, S., Yang, Q., “Cascading impact of lag on user experience in multiplayer games”, in *ACM NetGames*, 2014.
- [107] Beyer, J., Varbelow, R., Antons, J.-N., Möller, S., “Using electroencephalography and subjective self-assessment to measure the influence of quality variations in cloud gaming”, in *Quality of Multimedia Experience (QoMEX)*, 2015 7th Intl. Workshop on, May 2015, pp. 1-6.
- [108] Drachen, A., Nacke, L. E., Yannakakis, G., Pedersen, A. L., “Correlation between heart rate, electrodermal activity and player experience in first-person shooter games”, in *Proceedings of the 5th ACM SIGGRAPH Symposium on Video Games*, 2010, pp. 49–54.
- [109] Larradet, F., Barresi, G., Mattos, L. S., “Effects of galvanic skin response feedback on user experience in gaze-controlled gaming: a pilot study”, in *2017 39th Annual International Conference of the IEEE Engineering in Medicine and Biology Society (EMBC)*. IEEE, 2017, pp. 2458–2461.
- [110] ITU-T G.1032, “Recommendation ITU-T G.1032 - Influence factors on gaming quality of experience”, 2017.
- [111] ITU-T P.809, “Recommendation ITU-T P.809 - Subjective evaluation methods for gaming quality”, 2018.
- [112] ITU-T G.1072, “Recommendation ITU-T G.1072 - Opinion model predicting gaming quality of experience for cloud gaming services”, 2020.
- [113] Zadtootaghaj, S., Schmidt, S., Sabet, S. S., Möller, S., Griwodz, C., “Quality estimation models for gaming video streaming services using perceptual video quality dimensions”, in *Proceedings of the 11th ACM Multimedia Systems Conference*, 2020, pp. 213–224.
- [114] Sabet, S. S., Schmidt, S., Zadtootaghaj, S., Griwodz, C., Moller, S., “Towards the impact of gamers strategy and user inputs on the delay sensitivity of cloud games”, in *2020 Twelfth International Conference on Quality of Multimedia Experience (QoMEX)*. IEEE, 2020, pp. 1–3.

- [115] Zadtootaghaj, S., Schmidt, S., Möller, S., “Modeling gaming qoe: Towards the impact of frame rate and bit rate on cloud gaming”, in 2018 Tenth International Conference on Quality of Multimedia Experience (QoMEX). IEEE, 2018, pp. 1–6.
- [116] Ahmadi, H., Tootaghaj, S. Z., Hashemi, M. R., Shirmohammadi, S., “A game attention model for efficient bit rate allocation in cloud gaming”, *Multimedia Systems*, Vol. 20, No. 5, 2014, pp. 485–501.
- [117] Lee, Y.-T., Chen, K.-T., Su, H.-I., Lei, C.-L., “Are all games equally cloud-gaming-friendly? An electromyographic approach”, in 11th Ws on Net. and Sys. Support for Games, NetGames, 2012, pp. 1–6.
- [118] Wu, D., Xue, Z., He, J., “iCloudAccess: Cost-Effective Streaming of Video Games From the Cloud With Low Latency”, *IEEE Transactions on Circuits and Systems for Video Technology*, Vol. 24, No. 8, Aug 2014, pp. 1405-1416.
- [119] Hong, H., Chen, D., Huang, C., Chen, K., Hsu, C., “Placing virtual machines to optimize cloud gaming experience”, *IEEE Transactions on Cloud Computing*, Vol. 3, No. 1, Jan 2015, pp. 42-53.
- [120] Tian, H., Wu, D., He, J., Xu, Y., Chen, M., “On achieving cost-effective adaptive cloud gaming in geo-distributed data centers”, *IEEE Transactions on Circuits and Systems for Video Technology*, Vol. 25, No. 12, Dec 2015, pp. 2064-2077.
- [121] Basiri, M., Rasoolzadegan, A., “Delay-aware resource provisioning for cost-efficient cloud gaming”, *IEEE Transactions on Circuits and Systems for Video Technology*, Vol. 28, No. 4, April 2018, pp. 972-983.
- [122] Amiri, M., Sobhani, A., Osman, H. A., Shirmohammadi, S., “Sdn-enabled game-aware routing for cloud gaming datacenter network”, *IEEE Access*, Vol. 5, 2017, pp. 18 633-18 645.
- [123] Deng, Y., Li, Y., Seet, R., Tang, X., Cai, W., “The server allocation problem for session-based multiplayer cloud gaming”, *IEEE Transactions on Multimedia*, Vol. 20, No. 5, May 2018, pp. 1233-1245.
- [124] Dinaki, H. E., Shirmohammadi, S., “Gpu/qoe-aware server selection using metaheuristic algorithms in multiplayer cloud gaming”, in 2018 16th Annual Workshop on Network and Systems Support for Games (NetGames). IEEE, 2018, pp. 1–6.
- [125] Chen, D.-Y., El-Zarki, M., “A framework for adaptive residual streaming for single-player cloud gaming”, *ACM Transactions on Multimedia Computing, Communications, and Applications (TOMM)*, Vol. 15, No. 2s, 2019, pp. 1–23.

- [126] Guo, D., Han, Y., Cai, W., Wang, X., Leung, V. C., “Qoe-oriented resource optimization for mobile cloud gaming: A potential game approach”, in ICC 2019-2019 IEEE International Conference on Communications (ICC). IEEE, 2019, pp. 1–6.
- [127] Hegazy, M., Diab, K., Saeedi, M., Ivanovic, B., Amer, I., Liu, Y., Sines, G., Hefeeda, M., “Content-aware video encoding for cloud gaming”, in Proceedings of the 10th ACM multimedia systems conference, 2019, pp. 60–73.
- [128] Parastar, P., Pakdaman, F., Hashemi, M. R., “Frame-sdn: a fair resource allocation for multiplayer edge-based cloud gaming in sdn”, in Proceedings of the 25th ACM Workshop on Packet Video, 2020, pp. 21–27.
- [129] Yami, M. H., Pakdaman, F., Hashemi, M. R., “Sara-sdn: state aware resource allocation in sdn to improve qoe in cloud gaming”, in Proceedings of the 25th ACM Workshop on Packet Video, 2020, pp. 8–14.
- [130] Aboutorabi, S. J. S., Rezvani, M. H., “An optimized meta-heuristic bees algorithm for players’ frame rate allocation problem in cloud gaming environments”, *The Computer Games Journal*, Vol. 9, No. 3, 2020, pp. 281–304.
- [131] “Integrated Multiprotocol Network Emulator/Simulator”, developed at Univ. of Zagreb, Faculty of Electrical Engineering and Computing, online: <http://www.imunes.tel.fer.hr/>.
- [132] Huang, C.-Y., Hsu, C.-H., Chang, Y.-C., Chen, K.-T., “GamingAnywhere: An Open Cloud Gaming System”, in Proceedings of the 4th ACM Multimedia Systems Conference, ser. MMSys ’13. New York, NY, USA: ACM, 2013, pp. 36–47.
- [133] Liu, X., Sridharan, A., Machiraju, S., Seshadri, M., Zang, H., “Experiences in a 3g network: interplay between the wireless channel and applications”, in Proceedings of the 14th ACM international conference on Mobile computing and networking. ACM, 2008, pp. 211–222.
- [134] International Telecommunication Union, “Methods for subjective determination of transmission quality”, ITU-T Recommendation P.800, 1996.
- [135] Schmider, E., Ziegler, M., Danay, E., Beyer, L., Bühner, M., “Is it really robust? re-investigating the robustness of anova against violations of the normal distribution assumption.”, *Methodology: European Journal of Research Methods for the Behavioral and Social Sciences*, Vol. 6, No. 4, 2010, p. 147.
- [136] Fiedler, M., Hossfeld, T., Tran-Gia, P., “A generic quantitative relationship between quality of experience and quality of service”, *Network*, IEEE, Vol. 24, No. 2, 2010, pp. 36–41.

- [137] “Omnipeek Network Protocol Analyzer”, <https://www.liveaction.com/products/omnipeek-network-protocol-analyzer/>, [accessed 20.09.2020.].
- [138] “Wireshark Network Protocol Analyzer”, <https://www.wireshark.org/>, [accessed 20.09.2020.].
- [139] Claypool, K. T., Claypool, M., “On frame rate and player performance in first person shooter games”, *Multimedia systems*, Vol. 13, No. 1, 2007, pp. 3–17.
- [140] Claypool, M., Decelle, J., Hall, G., O’Donnell, L., “Surrender at 20? Matchmaking in League of Legends”, in *Games Entertainment Media Conference (GEM)*, 2015 IEEE. IEEE, 2015, pp. 1–4.
- [141] Kim, H.-S., Yoon, C.-H., “Determinants of subscriber churn and customer loyalty in the korean mobile telephony market”, *Telecommunications policy*, Vol. 28, No. 9-10, 2004, pp. 751–765.
- [142] ITU-T Recommendation, P., “Subjective video quality assessment methods for multimedia applications”, 1999.
- [143] Kanopoulos, N., Vasanthavada, N., Baker, R. L., “Design of an image edge detection filter using the sobel operator”, *IEEE Journal of solid-state circuits*, Vol. 23, No. 2, 1988, pp. 358–367.
- [144] Claypool, M., “Motion and scene complexity for streaming video games”, in *Proceedings of the 4th International Conference on Foundations of Digital Games*. ACM, 2009, pp. 34–41.
- [145] Rousseeuw, P. J., “Silhouettes: a graphical aid to the interpretation and validation of cluster analysis”, *Journal of Computational and Applied Mathematics*, Vol. 20, 1987, pp. 53–65.
- [146] Kaufman, L., Rousseeuw, P. J., *Finding groups in data : an introduction to cluster analysis*, ser. *Wiley series in probability and mathematical statistics*. New York: Wiley, 1990, a Wiley-Interscience publication., Available at: <http://opac.inria.fr/record=b1087461>
- [147] Slivar, I., Skorin-Kapov, L., Suznjevic, M., “QoE-Aware Resource Allocation for Multiple Cloud Gaming Users Sharing a Bottleneck Link”, in *2019 22nd Conference on Innovation in Clouds, Internet and Networks and Workshops (ICIN)*. IEEE, 2019, pp. 118–123.

- [148] Hoßfeld, T., Skorin-Kapov, L., Heegaard, P. E., Varela, M., “Definition of qoe fairness in shared systems”, *IEEE Communications Letters*, Vol. 21, No. 1, 2017, pp. 184–187.
- [149] Hoßfeld, T., Heegaard, P. E., Skorin-Kapov, L., Varela, M., “No silver bullet: QoE metrics, QoE fairness, and user diversity in the context of QoE management”, in *9th Intl. Conf. on QoMEX*. IEEE, 2017, pp. 1–6.
- [150] “Shadow introduces their newest venture: the VR Exploration Program!”, <https://community.shadow.tech/user/blog/news/shadow-vr-exploration>, [accessed 16.09.2020.].

List of Figures

1.1. Mapping of addressed research questions, activities comprising the research methodology, and contributions of the thesis. Publications corresponding to each contribution are listed.	6
1.2. Overall methodology used in this doctoral thesis	9
2.1. Cloud gaming service	11
2.2. Cloud gaming architecture adopted from [3]	12
3.1. QoE ecosystem as reported in [80]	24
3.2. Quality features of gaming QoE taken from [111]	29
3.3. An example of evaluation procedure for online gaming	30
3.4. The model structure taken from [112]	32
4.1. Laboratory testbed in Study S1	40
4.2. Study S1 methodology	42
4.3. Subjective ratings of overall QoE during online gaming and degradations of overall QoE during cloud gaming	43
4.4. Accuracy of predicted MOS ratings vs subjective MOS ratings	44
4.5. Accuracy of predicted DMOS ratings vs subjective DMOS ratings	45
4.6. QoE degradation ratings depending on QoE ratings	46
4.7. Impact of additional constant degradation on perceived QoE	46
4.8. Willingness to play based on user gaming skill	47
4.9. Laboratory testbed for testing GeForce NOW service adaptation behavior	49
4.10. Bandwidth usage for (top to bottom) Drift 3, Ultra Street Fighter 4 and Pumped BMX +	50
4.11. Adaptation with active gameplay in Dirt 3	53
4.12. Adaptation with passive gameplay in Dirt 3	53
4.13. Quality levels of tested games on various bandwidths	55

4.14. Subjective scores for QoE, perceived fluidity, and perceived graphics quality, across three tested games and under various latency, bandwidth availability, and loss conditions.	57
4.15. Willingness to continue playing (results aggregated across all games)	59
5.1. Laboratory testbed used in Study S3	63
5.2. Subjective ratings of overall QoE (95% CI) for tested games in Study S3	65
5.3. Aggregated subjective ratings for each tested game in Study S3 under different video configurations	66
5.4. Percentage of players willing to keep playing under different test conditions for tested games in Study S3	67
5.5. Summary of linear regression models for QoE with video parameters and QoE features for tested games in Study S3	68
5.6. Accuracy of predicted QoE ratings vs subjective QoE ratings collected in Study S3 for Serious Sam 3	69
5.7. Accuracy of predicted QoE ratings vs subjective QoE ratings collected in Study S3 for Bastion	69
5.8. Laboratory testbed in Study S4	71
5.9. Comparison of game characteristics for Serious Sam 3 and Hearthstone. Points on the different axis represent different levels as described in the text.	72
5.10. Subjective ratings of overall QoE (95% CI) for tested games in Study S4	75
5.11. Aggregated subjective ratings for each tested game in Study S4 under different video configurations	76
5.12. Willingness to continue playing under different test conditions for both tested games in Study S4	77
5.13. Average user ratings for QoE depending on the test condition order in the experiment for both tested games in Study S4	77
5.14. Subjective ratings of overall QoE (95% CI) for SS3 and HS grouped by skill	78
5.15. Mean ratings of overall QoE per skill level for different test scenario in Study S4 (scenarios arranged according to ascending mean QoE)	79
5.16. MOS scores for different frame rates at a fixed bitrate of 10 Mbps for SS3	80
5.17. Impact of degradations on QoE for tested games in Study S4	80
5.18. The impact of group composition on QoE for tested games in Study S4 (avg. values and 95% CI)	81
5.19. Impact of video parameters on overall MOS scores for SS3 and HS (Study S4)	82
5.20. GoB ratio of scores for tested games in Study S4	83
5.21. PoW scores for tested games in Study S4	84

5.22. Acceptability ratios and MOS for QoE (with 95% CIs) per experiment for tested games in Study S4	85
5.23. Distribution of Standard deviation of Opinion Scores (SOS) for tested games in Study S4	85
5.24. Illustrated QoE models for Serious Sam 3 and Hearthstone	86
5.25. Graphical representation of QoE models for Serious Sam 3 and Hearthstone depending on player skill	87
5.26. Accuracy of estimated QoE ratings vs subjective QoE ratings for tested games in Study S4	88
5.27. Comparison of game characteristics for tested games in Study S5	90
5.28. Subjective ratings of overall QoE (95% CI) in Study S5	92
5.29. Aggregated subjective ratings for each game under different video configurations	93
5.30. Willingness to continue playing under different test conditions for both tested games	94
5.31. Subjective ratings of overall QoE (95% CI) for SS3 and OMD grouped by skill	94
5.32. Mean ratings of overall QoE per skill level for different test scenario (scenarios arranged according to ascending mean QoE) for Study S5	95
5.33. Impact of video parameters on overall MOS scores for tested games in Study S5	96
5.34. GoB scores for tested games in Study S5	96
5.35. PoW scores for tested games in Study S5	97
5.36. Acceptability ratios and MOS for QoE (with 95% CIs) per experiment for tested games in Study S5	98
5.37. Distribution of Standard deviation of Opinion Scores (SOS) for tested games in Study S5	98
5.38. Illustrated QoE models for Serious Sam 3 and Orcs Must Die: Unchained! . . .	99
5.39. Comparison of game characteristics for the tested games in Study S6	100
5.40. Subjective ratings of overall QoE (95% CI) in Study S6	102
5.41. Aggregated subjective ratings for each game in Study S6 under different video configurations	102
5.42. Willingness to continue playing under different test conditions for tested games in Study S6	103
5.43. Subjective ratings of overall QoE (95% CI) for Bastion and HotS grouped by skill	104
5.44. Mean ratings of overall QoE per skill level for different test scenario (scenarios arranged according to ascending mean QoE) for Study S6	104
5.45. Impact of video parameters on overall MOS scores for Bastion and HotS in Study S6	105
5.46. GoB scores for tested games in Study S6	106

5.47. PoW scores for tested games in Study S6	106
5.48. Acceptability ratios and MOS for QoE (with 95% CIs) per experiment for tested games in Study S6	107
5.49. Distribution of Standard deviation of Opinion Scores (SOS) for tested games in Study S6	108
5.50. Illustrated QoE models for Bastion and Heroes of the Storm	109
5.51. Graphical representation of QoE models for HotS and Bastion depending on player skill	109
6.1. Scores for different video metric for tested games	114
6.2. The impact of the chosen number of clusters on the silhouette coefficient for different sets of input metrics. The complete set of collected metrics includes: SI, TI, PFIM, IBS, average actions per minute (APM).	117
6.3. Silhouette plot of the collected data for $k = 2$	118
6.4. k-means clustering results of video games for $k=2$	119
6.5. PFIM and IBS scores for different gameplay traces. Each point corresponds to metrics derived from one gameplay trace lasting 30 seconds	119
6.6. Silhouette plot of the collected data for $k = 3$	121
6.7. k-means clustering results of video games for $k=3$	122
6.8. Visualization of the obtained clusters, analyzed according to input metrics used in clustering (PFIM, IBS, APM)	123
7.1. Deriving concrete per-game category adaptation strategies based on chosen adaptation approach	127
7.2. Frame rate configurations based on QoE estimation models for the game categories given achievable bitrate and fixed resolution of 720p	129
7.3. Quartiles for MOS scores derived from QoE models for the game categories	130
7.4. MOS for Game categories FP and SP-L derived based on QoE models: MOS as a function of bitrate assuming frame rate adaptation, and compared to MOS values with fixed frame rates	130
7.5. Proposed video encoding adaptation approach B: frame rate adaptation defined for different bitrate ranges. The target codec bitrate is set to the maximum achievable bitrate that can be transmitted given network constraints.	131
7.6. Proposed video encoding adaptation approach C: frame rate and bitrate adaptation defined for different bitrate ranges.	132
8.1. Cloud gaming service delivered to multiple users over a shared bottleneck link	135
8.2. CDF of MOS scores for the tested resource allocation algorithms. 300 concurrent players assumed in the system, with 100 per game category.	140

8.3.	Average MOS scores for different numbers of users in the system. Results for four different optimization objectives are portrayed, which determine the amount of resources (bitrate) assigned to each player. Adaptation approach A is assumed for the purpose of mapping MOS to bitrate values.	141
8.4.	Distribution of average MOS scores across scenarios with 100 - 400 users. Distributions portrayed for the four optimization algorithms while utilizing Adaptation approach A.	142
8.5.	Distribution of minimum MOS scores across scenarios with 100 - 400 users. Distributions portrayed for the four optimization algorithms while utilizing Adaptation approach A.	143
8.6.	Average bitrate for the tested algorithms while utilizing Adaptation approach A	144
8.7.	Distribution of average bitrate across scenarios with 100 - 400 users. Distributions portrayed for the four optimization algorithms while utilizing Adaptation approach A.	145
8.8.	Distribution of average frame rate across scenarios with 100 - 400 users. Distributions portrayed for the four optimization algorithms while utilizing Adaptation approach A.	146
8.9.	Average per-game category MOS scores for Adaptation approaches A, B, and C while utilizing the max-avg quality resource allocation algorithm	147
8.10.	Distribution of average per-game category MOS scores for Adaptation approaches A, B, and C while utilizing the max-avg quality resource allocation algorithm .	148
8.11.	Average per-game category bitrate for Adaptation approaches A, B, and C while utilizing the max-avg quality resource allocation algorithm	148
8.12.	Average per-game category frame rate for Adaptation approaches A, B, and C while utilizing the max-avg quality resource allocation algorithm	149
8.13.	Average per-game MOS scores for Adaptation approaches A, B, and C while utilizing the max-min quality resource allocation algorithm	149
8.14.	Distribution of average per-game category MOS scores Adaptation approaches A, B, and C while utilizing the max-min quality resource allocation algorithm .	150
8.15.	Average per-game category bitrate for Adaptation approaches A, B, and C while utilizing the max-min quality resource allocation algorithm	150
8.16.	Average per-game category frame rate for Adaptation approaches A, B, and C while utilizing the max-min quality resource allocation algorithm	150
8.17.	Average MOS scores for Game category FP and SS3 for Adaptation approaches A, B, and C while utilizing the max-min quality resource allocation algorithm .	151
8.18.	CDFs for allocated video bitrates and MOS scores in a scenario with 175 users. Different values of θ illustrate the impact of fairness relevance.	152

List of Tables

1.1. Summary of conducted user studies	8
2.1. Overview and comparison of cloud gaming platforms, indicating market availability.	16
3.1. Overview of studies addressing cloud gaming QoE	33
4.1. Subjective ratings collected during the test procedure	42
4.2. Measured parameters of our network compared to required and recommended parameters for GFN	49
5.1. Summary of differences between conducted user studies	62
5.2. Correlations between ratings and video parameters (** <i>p</i> -value < 0.001, ** <i>p</i> -value < 0.01, * <i>p</i> -value < 0.05)	66
5.3. The QoE models for tested games in Study S4	86
5.4. The QoE models for tested games in Study S5	99
5.5. The QoE models for tested games in Study S6	108
6.1. Selected games for recording video game traces	116
6.2. Differences between derived clusters regarding video metrics and gameplay characteristics	122
7.1. QoE models for proposed game categories	125
8.1. Used notation in the optimization problem	136

List of Abbreviations

ACR Absolute Category Rating

ANOVA Analysis of Variance

APM Actions per minute

CBR Constant bitrate

CQP Constant Quantization Parameter

CRF Constant rate factor

FPS First Person Shooter

GEQ Game Experience Questionnaire

GOB Good or Better

GOP Group of pictures

HCI Human-computer interaction

HD High-definition

HDR High-dynamic-range

IBS Intra-coded Block Size

IMUNES Integrated Multiprotocol Network Emulator/Simulator

ITU-T International Telecommunication Union - Telecommunication Standardization Sector

MMORPG Massive Multiplayer Online Role Playing Game

MOS Mean Opinion Score

PFIM Percentage of Forward/backward or Intra-coded Macroblocks

POW Poor or Worse

QoE Quality of Experience

QoS Quality of Service

QP Quantization parameter

QUIC Quick UDP Internet Connections (not used as an acronym within IETF RFC)

RD Rate-distortion

List of Abbreviations

RPG Role Playing Game

RTCP RTP Control Protocol

RTP Real-time Transport Protocol

RTS Real Time Strategy

RTT Round trip time

SI Spatial perceptual information

SOS Standard deviation of Opinion Scores

TCP Transmission Control Protocol

TI Temporal perceptual information

UDP User Datagram Protocol

VM Virtual machine

VOD Video on Demand

VR Virtual reality

WebRTC Web Real-Time Communication

Biography

Ivan Slivar is an Assistant at the Department of Telecommunication, Faculty of Electrical Engineering and Computing, University of Zagreb. He received his B.Sc. degree in the field of Computing in July 2010 and his M.Sc. degree in the field of Information and Communication Technologies in July 2012. After acquiring his Master's degree, he enrolled in 2013 as a Ph.D. student at the Faculty of Electrical Engineering and Computing, University of Zagreb under the supervision of Assistant Professor Lea Skorin-Kapov. In July 2014, he passed the qualifying examination, and in April 2016 his doctoral thesis topic was approved.

The focus of his research is in the field of Quality of Experience (QoE) for cloud gaming. In particular, he is focusing on the impact of various encoding, network, and contextual factors on user perceived QoE in the context of cloud gaming, aiming to propose QoE-driven service and network adaptation strategies. His research is conducted in the scope of activities of The Multimedia Quality of Experience Research Lab (MUEXlab), and projects funded by the Croatian Science Foundation. He has authored or coauthored over 10 conference papers and a journal paper. He is a member of the IEEE Croatia section.

List of publications

Publications numbered as [1], [2], [3], [4], [5], [6], [7], [8], and [11] represent work incorporated in this thesis, while publications [9], [10], [12], and [13] are out of the scope of the thesis.

Journal papers

1. Slivar, I., Sužnjević, M., Skorin-Kapov, L., “Game Categorization for Deriving QoE-driven Video Encoding Configuration Strategies for Cloud Gaming”, *ACM Transactions on Multimedia Computing, Communications, and Applications (TOMM)*, Vol. 14, No. 3s, 2018, pp. 1–24.

Conference papers

1. Slivar, I., Skorin-Kapov, L., Sužnjević, M., “QoE-Aware Resource Allocation for Multiple Cloud Gaming Users Sharing a Bottleneck Link”, in 2019 22nd Conference on Innovation in Clouds, Internet and Networks and Workshops (ICIN). IEEE, 2019, pp. 118–123.
2. Slivar, I. and Skorin-Kapov, L., "Quality of Experience Driven Video Encoding Adaptation Strategies for Cloud Gaming under Network Constraints", in 15th International Conference on Telecommunications (ConTEL) - PhD Forum, 2017, pp. 1–2.
3. Slivar, I., Sužnjević, M., Skorin-Kapov, L., Ilić, V., “Cloud Gaming in Education: Evaluation of Multiple Game Streams in a Shared WLAN”, in Zooming Innovation in Consumer Electronics International Conference (ZINC). IEEE, 2016, pp. 62–65.
4. Slivar, I., and Skorin-Kapov, L., "Quality of Experience Driven Video Encoding Adaptation Strategies for Cloud Gaming under Network Constraints", in 28th International Conference on Software, Telecommunications and Computer Networks (SoftCOM) - PhD Forum, 2016, pp. 1-2.
5. Sužnjević, M., Slivar, I., Skorin-Kapov, L., “Analysis and QoE Evaluation of Cloud Gaming Service Adaptation under Different Network Conditions: The Case of NVIDIA GeForce NOW”, in 8th International Conference on Quality Of Multimedia Experience (QoMEX). IEEE, 2016, pp. 1–6.
6. Slivar, I., Skorin-Kapov, L., Sužnjević, M., “Cloud Gaming QoE Models for Deriving Video Encoding Adaptation Strategies”, in Proceedings of the 7th International Conference on Multimedia Systems (MMSys '16), 2016, pp. 1–12.
7. Slivar, I., Dragozet, Z., Skorin-Kapov, L., “User Customization of the GamingAnywhere Android Mobile Client Interface”, in International Workshop on Network and Systems Support for Games (NetGames). IEEE, 2015, pp. 1–3.
8. Slivar, I., Sužnjević, M., Skorin-Kapov, L., “The Impact of Video Encoding Parameters and Game Type on QoE for Cloud Gaming: A Case Study using the Steam Platform”, in 7th International Workshop on Quality of Multimedia Experience (QoMEX), May 2015, pp. 1-6.
9. Babić, J., Slivar, I., Car, , Podobnik, V., “Prototype-driven Software Development Process for Augmentative and Alternative Communication Applications”, in 13th International Conference on Telecommunications (ConTEL). IEEE, 2015, pp. 1–8.

10. Babić, J., Slivar, I., Šemanjski, I., Vuković, M., Car, Ž., Podobnik, V., “Innovative Information and Communication Services for Persons with Complex Communication Needs”, in the 22nd Annual Conference of Croatian Psychologists with international contribution, 2014.
11. Slivar, I., Sužnjević, M., Skorin-Kapov, L., Matijašević, M., “Empirical QoE Study of In-home Streaming of Online Games”, in 13th Annual Workshop on Network and Systems Support for Games (NetGames), 2014, pp. 1-6.
12. Feješ, A., Pavliša, J. I., Slivar, I., “Communication and Language and a AAC system-A Case of a Girl with Wolf-Hirschhorn Syndrome”, in 16th Biennial Conference of ISAAC, 2014.
13. Antonić, A., Slivar, I., Podnar Žarko, I., “Follow me!—A Rich Presence Application for Smartphones”, in 20th International Conference on Software, Telecommunications and Computer Networks (SoftCOM). IEEE, 2012, pp. 1–5.

Životopis

Ivan Slivar je asistent na Zavodu za telekomunikacije Fakulteta elektrotehnike i računarstva Sveučilišta u Zagrebu. Diplomom sveučilišnog prvostupnika inženjera Računarstva prima 2010. g., a diplomu magistra inženjera struke Informacijske i komunikacijske tehnologije 2012. g. Nakon diplomiranja, upisao je 2013. g. poslijediplomski doktorski studij na Fakultetu elektrotehnike i računarstva Sveučilišta u Zagrebu pod mentorstvom docentice Lee Skorin-Kapov. U srpnju 2014. g. položio je kvalifikacijski doktorski ispit, a u travnju 2016. održao javni razgovor.

Njegovo glavno područje istraživačkog interesa je iskustvena kvaliteta (QoE) igara zasnovanih na računalnom oblaku. Posebno je fokusiran na istraživanje utjecaja kodiranja, mreže i kontekstualnih faktora na iskustvenu kvalitetu percipiranu od strane korisnika u području igara zasnovanih na računalnom oblaku, s ciljem da predloži strategije prilagodbe usluga i mreže usmjerene poboljšavanju iskustvene kvalitete korisnika. Istraživanje provodi u sklopu aktivnosti Laboratorija za istraživanje iskustvene kvalitete višemedijskih usluga (MUEXlab) i projekata financiranih od strane HRZZ-a. Objavio je desetak radova na međunarodnim konferencijama, te jedan rad u časopisu. Član je hrvatske sekcije IEEE.