

# Modelling and evaluation of flexible multi-energy systems for low carbon environment.

---

Holjevac, Ninoslav

Doctoral thesis / Disertacija

2019

*Degree Grantor / Ustanova koja je dodijelila akademski / stručni stupanj:* **University of Zagreb, Faculty of Electrical Engineering and Computing / Sveučilište u Zagrebu, Fakultet elektrotehnike i računarstva**

*Permanent link / Trajna poveznica:* <https://urn.nsk.hr/urn:nbn:hr:168:933155>

*Rights / Prava:* [In copyright](#) / [Zaštićeno autorskim pravom.](#)

*Download date / Datum preuzimanja:* **2025-01-17**



*Repository / Repozitorij:*

[FER Repository - University of Zagreb Faculty of Electrical Engineering and Computing repository](#)





University of Zagreb  
FACULTY OF ELECTRICAL ENGINEERING AND  
COMPUTING

Ninoslav Holjevac

**MODELLING AND EVALUATION OF  
FLEXIBLE MULTI-ENERGY SYSTEMS  
FOR LOW CARBON ENVIRONMENT**

DOCTORAL THESIS

Zagreb, 2019



University of Zagreb  
FACULTY OF ELECTRICAL ENGINEERING AND  
COMPUTING

Ninoslav Holjevac

**MODELLING AND EVALUATION OF  
FLEXIBLE MULTI-ENERGY SYSTEMS  
FOR LOW CARBON ENVIRONMENT**

DOCTORAL THESIS

Supervisor: Professor Igor Kuzle, PhD

Zagreb, 2019



Sveučilište u Zagrebu  
FAKULTET ELEKTROTEHNIKE I RAČUNARSTVA

Ninoslav Holjevac

**MODELIRANJE I VREDNOVANJE  
FLEKSIBILNIH VIŠE-ENERGIJSKIH  
SUSTAVA U NISKOUGLJIČNOM  
OKOLIŠU**

DOKTORSKI RAD

Mentor: prof. dr. sc. Igor Kuzle

Zagreb, 2019.

The doctoral thesis was completed at the University of Zagreb Faculty of Electrical Engineering and Computing, Department of Energy and Power Systems, Zagreb, Croatia

Supervisor: Professor Igor Kuzle, PhD

The thesis has: 145 pages

Thesis number: \_\_\_\_\_

## **ABOUT THE SUPERVISOR**

Igor Kuzle was born in Tuzla in 1967. He received B.Sc., M.Sc. and Ph.D. degrees in electrical engineering from the University of Zagreb Faculty of Electrical Engineering and Computing (FER), Zagreb, Croatia, in 1991, 1997 and 2002, respectively. From July 1992, he has been working at the Department of Energy and Power Systems at FER and since 2014 he has been the Head of the Department. In 2015 he was promoted to a Full Professor and in 2017 he was promoted to a Tenured Scientific Adviser. He is a member of two scientific councils of the Croatian Academy of Sciences and Arts (Scientific Council for Technological Development and Scientific Council for Crude Oil and Gas Economy and Power Supply). Since 2017 he has been an associate member of the Croatian Academy of Engineering. Prof. Kuzle was awarded Croatian National Science Award for the year 2017 for his outstanding contribution in the field of smart grid applications in the transmission system. In 2016 he received annual FER's award Science for outstanding achievements in research work and innovations in the last five years.

He participated in seven scientific projects financed by the Ministry of Science, Education and Sports of the Republic of Croatia and three EU FP7 projects. Currently he is a FER's coordinator of two H2020 projects (CROSSBOW and IRES-8) and project leader of two national research projects (FENISG and WINDLIPS) financed by the Croatian Science Foundation, as well as the Croatia-China bilateral project WIND ASP.

He published 27 papers in A Category journals and over 100 papers in international conference proceedings in the area of smart grids and power systems dynamics. He also coauthored over 200 technical studies for utilities and private companies being the project leader of 75 such projects.

Prof. Kuzle is a member of IEEE (2009-2012 IEEE Croatia Section Chair, 2015-2016 IEEE Region 8 Vice Chair for Technical Activities), an associate member of the Croatian Academy of Engineering (HATZ), and a member of CIGRE member (2009-2012 Croatian National Committee CIGRE executive board).

Since 2012 he has been a member of Croatia TSO Coordination Group for Connection of Renewable Energy Sources and a member of the Advisory Expert Committee of the Ministry of Environmental and Nature Protection in the evaluation of environmental impact of the Renewable Energy Sources. He is a member of technical commission for assigning Croatian quality mark of the Croatian Chamber of Economy and a member of the Croatian Chamber of Electrical Engineers and a Licensed Engineer since 1994.

He chaired three international conferences (IET Medpower 2018, IEEE Energycon 2014, IEEE Eurocon 2013) and was a member of 50 international conferences programs committees. He serves as an editorial board member for 10 international scientific journals of which he is a Guest Editor in 4. He has participates in the review process of many scientific papers.

His scientific interests include problems in electric power systems' dynamics and control, maintenance of electrical equipment, as well as smart grids and integration of renewable energy sources.

## O MENTORU

Igor Kuzle rođen je u Tuzli 1967. godine. Diplomirao je, magistrirao i doktorirao u polju elektrotehnike na Sveučilištu u Zagrebu Fakultetu elektrotehnike i računarstva (FER), 1991., 1997. odnosno 2002. godine. Od srpnja 1992. godine radi na Zavodu za visoki napon i energetiku FER-a čiji je predstojnik od 2014. godine. U siječnju 2015. godine izabran je u zvanje redovitog profesora, a u studenome 2017. izabran je u znanstvenog savjetnika u trajnom zvanju. Član je dva znanstvena vijeća Hrvatske akademije tehničkih znanosti (HATZ), Znanstvenog vijeća za tehnološki razvoj i Znanstvenog vijeća za naftno-plinsko gospodarstvo i energetiku. Prof. Kuzle je nagrađen Nacionalnom nagradom za znanost za 2017. godinu za svoj doprinos znanosti u području naprednih mreža u prijenosnom sustavu te Nagradom za znanost FER-a za svoj izniman istraživački doprinos u razdoblju od 2010 do 2015.

Sudjelovao je na sedam znanstvenih projekata Ministarstva znanosti, obrazovanja i sporta Republike Hrvatske te tri EU FP7 projekta. Trenutno je voditelj istraživačkog HRZZ projekta WINDLIPS i koordinator na dva H2020 projekta (CROSSBOW i IRES-8) te jednom bilateralnom projektu s Republikom Kinom WIND ASP).

Objavio je 27 radova u časopisima A kategorije i više od 100 radova u zbornicima međunarodnih konferencija u području naprednih mreža i dinamike elektroenergetskog sustava. Također, koautor je preko 200 tehnički studija i elaborata u području energetike od kojih je za njih preko 75 bio i voditelj.

Prof. Kuzle član je stručne udruge IEEE (2009.-2012. predsjednik Hrvatske sekcije IEEE, 2015.-2016. dopredsjednik za tehničke aktivnosti IEEE Regije 8), član suradnik Akademije tehničkih znanosti Hrvatske (HATZ) te član stručne udruge CIGRE (2009-2012 član izvršnog odbora hrvatskog ogranka CIGRE). Član je Odbora za znanost i međunarodnu suradnju Sveučilišta u Zagrebu te potpredsjednik za znanost Matičnog odbora za elektrotehniku i računarstvo Nacionalnog vijeća za znanost, visoko obrazovanje i tehnološki razvoj. Dodatno, član je Odbora za priključak obnovljivih izvora energije Hrvatskog operatora prijenosnog sustava (HROTE) te član stručnog savjetodavnog odbora za procjenu utjecaja na okoliš obnovljivih izvora energije Ministarstva zaštite okoliša i energetike (MZOE). Član je odbora za dodjelu znaka „Hrvatska kvaliteta“ Hrvatske gospodarske komore te je član Hrvatske komore inženjera i ovlaštenu inženjer od 1994.

Bio je predsjedavajući tri međunarodne konferencije (IET MEDPOWER 2018, IEEE Energycon 2014, IEEE Eurocon 2013) i član u više od 50 međunarodnih programskih odbora



znanstvenih konferencija. Član je uredničkih odbora 10 znanstvenih časopisa (u četiri je gostujući urednik) te sudjeluje kao recenzent u većem broju inozemnih časopisa.

Znanstveni interesi prof. Kuzle uključuju dinamiku elektroenergetskog sustava, održavanje energetske opreme te napredne mreže i integraciju obnovljivih izvora energije u elektroenergetski sustav.

## **PREFACE AND CREDITS**

This thesis is based on results of the research conducted from 2014 to 2019 mostly as part of the project "FENISG - Flexible Energy Nodes In Low Carbon Smart Grid" funded by the Croatian Science Foundation under grant number IP-2013-11-7766 and project "IRES-8 – Instigation of Research and Innovation Partnership on Renewable Energy, Energy Efficiency and Sustainable Energy Solutions for Cities" funded by European Commission through the program of "EU-China research and innovation partnership" and supervised by professor Igor Kuzle, PhD.

This dissertation was completed thanks to the incredible people who helped shaping it. I am deeply grateful to my supervisor prof. Kuzle and to my colleague prof. "Cap" Capuder for the guidance and continuous support during my work. My friends, coworkers and roommates Matija Zidar and Ivan Pavić must be given huge thanks for numerous discussions, help and advice provided.

I also finally wish to give my inexpressible thanks to my family. It was a great effort for them also. Specially for my wife Katarina and our kids Iva, Marta and Lovro. Without their understanding and smiles this thesis would have not been completed.

## SHORT ABSTRACT

Aggregating groups of consumers of different energy vectors and generating units at a single location with centralized control is known as the concept of multi-energy microgrid (MEM). However, if those potentially flexible producers and consumers do not have the ability to balance the variability and uncertainty of their renewable energy sources production within them, from the system perspective, they are seen as a source of imbalances and potential problems in maintaining the equilibrium of production and consumption. One of the key characteristics of the microgrid operation that needs to be achieved is flexibility. Main goal of this research is to quantify this ability of MEM components to provide flexibility, as well as the impact different energy vectors have on overall flexibility and to estimate the effect the configuration of MEM and modelling concepts have on flexibility indicators. This flexibility is analyzed from two perspectives, defining two operating principles: independently from the distribution grid in island operation and connected, interacting and responding to signals from the upstream system. When MEM is connected to the upstream power system its flexibility manifests as capability to alleviate variability and uncertainty in local production of renewable energy sources and demand. On the other hand, when operating isolated from the rest of the system, the main flexibility indicator is minimum energy curtailment while ensuring the satisfaction of all demand (electrical, heating and cooling). The thesis presents a MILP (Mixed Integer Linear Programming) model applied under corrective receding horizon approach in order to capture the value of integrating multiple energy vectors, their optimal operation and their flexibility potential for low carbon energy system.

Scientific contributions of the thesis are:

- Mixed integer linear optimisation model for planning and estimating long-term flexibility aspects of multi-energy microgrids;
- Receding horizon corrective scheduling based algorithm for optimal short-term operation of flexible multi-energy microgrids;
- Model for defining the potential and value of flexibility services of multi-energy microgrids to a low-carbon power system operation.

**Keywords:** multi-energy systems, microgrid, flexibility, operational research, mixed integer linear optimization

## **EXTENDED ABSTRACT (PROŠIRENI SAŽETAK)**

### **Modeliranje i vrednovanje fleksibilnih višeenergijskih sustava u niskougljičnom okolišu**

Agregiranje grupa potrošača različitih energetskektora te različitih proizvodnih jedinica na jednome mjestu pomoću centralnog upravljanja naziva se konceptom višeenergijskih mikromreža. No, ako je slučaj da ovi potencijalno fleksibilni potrošači i proizvođači nemaju mogućnost balansiranja varijabilnosti i neizvjesnosti proizvodnje iz obnovljivih izvora energije, onda će, od strane ostatka sustava, biti razmatrani kao izvor poremećaja u održavanju ravnoteže između proizvodnje i potrošnje. Mogućnost ostvarivanja fleksibilnog odziva u pogonu mikromreža cilj je upravljanja svim elementima mikromreže. Ovo istraživanje ima osnovni cilj kvantificirati utjecaj koji različiti elementi više-energijskih mikromreža imaju na fleksibilnost pogona, kvantificirati utjecaj različitih energetskektora na fleksibilnost pogona te procijeniti utjecaj korištenja različitih koncepata modeliranja na indikatore fleksibilnosti. Fleksibilnost pogona je analizirana iz dvije perspektive, definirajući dva osnovna principa rada: neovisno o ostatku sustava u otočnom radu te paralelno s distribucijskim sustavom odgovarajući na različite signale koji dolaze iz sustava i koje definira sveukupni elektroenergetski sustav. Kada više-energijska mikromreža radi paralelno s ostatkom sustava njezina fleksibilnost pogona se očituje kao mogućnost smanjivanja utjecaja varijabilnosti proizvodnje obnovljivih izvora energije i ostvarenih iznosa potrošnje. Time se postiže smanjivanje troškova pogona, smanjuju emisije stakleničkih plinova i povećava mogućnost integracije dodatnih kapacitete obnovljivih izvora energije bez velikih zahtjeva. S druge strane, prilikom izoliranog (otočnog) pogona glavni kada mikromreža mora u svakom trenutku zadovoljiti sve potrošače bez mogućnost uvoza ili izvoza u ostatak sustava, indikator fleksibilnosti je najmanji mogući iznos neiskorištene energije i propuštene proizvodnje uz zadovoljavanje cijelog iznosa potrošnje električne energije, toplinske energije i energije za hlađenje). Planiranje rada i dimenzioniranje mikromreže, odnosno općenito više-energijskih sustava razlikuje se u ovisnosti o ciljevima koje taj sustav treba zadovoljiti na što utječe mnoštvo čimbenika. Kako bi se uvažili utjecaji svih čimbenika na odgovarajući način cijeli sustav je potrebno egzaktno matematički modelirati i provesti proces optimizacije kako bi se postigli optimalni rezultati. Razvoj modela koji može sagledati mnog čimbenike i sagledati više različitih aspekata pogona više-energijskih sustava može doprinijeti ubrzanju pronalaska rješenja za povećane zahtjeve elektroenergetskog sustava uzrokovane porastom udjela nepredvidive proizvodnje iz obnovljivih izvora energije. U sklopu provedenog istraživanja

razvijen je simulacijski okvir koji koristi optimizacijski postupak spojen s upravljačkim algoritmom. Sukladno tome, doktorski rad opisuje mješovito cjelobrojni optimizacijski model koji je korišten unutar simulacijskog okvira te koji je proširen s korektivnim upravljanjem temeljenim na pristupu pomičnog horizonta. Razvijeni optimizacijski okvir uspješno prikazuje utjecaj povezivanja više energetske vektora na različitim horizontima planiranja, njihovo optimalno upravljanje u dnevnom pogonu i planiranju pogona sljedećeg vremenskog koraka te konačno potencijal fleksibilnog pogona koji više-energijski sustavu imaju u niskougljičnom elektroenergetskom sustavu.

Prema gore opisanim premisama i osnovnim pretpostavkama, cilj ovog istraživanja i doktorskog rada je definirati opsežni i ujedineni tehno-ekonomski i okolišni optimizacijski i upravljački okvir za evaluaciju i ostvarivanje fleksibilnosti pogona različitih više-energetskih sustava. Kao najvažniji razmatrani aspekt pomoću razvijenog optimizacijskog okvira i provedeno istraživanje koncept fleksibilnosti je prikazan iz dvije perspektive za različite konfiguracije višeenergijskih sustava i za različite ciljeve upravljanja:

- a) Fleksibilnost u fazi planiranja – ostvaruje se kao mogućnost utjecaja na potencijalnu dugoročnu fleksibilnost više-energijskog sustava koja se uz zadovoljenje preduvjeta može ostvariti sudjelovanjem na tržištu električne energije dan unaprijed i sudjelovanje na unutar-dnevnom tržištu kroz optimalnu selekciju i dimenzioniranje elemenata. Ovim postupkom ostvaruju se najbolji pokazatelji fleksibilnosti, minimalni troškovi i minimalni utjecaj na okoliš (smanjenje emisija i potrošnje goriva) kroz cijeli planirani životni vijek sustava i svih njegovih elemenata;
- b) Fleksibilnost dnevnog pogona – ostvaruje se u pogonu u stvarnom vremenu kao mogućnost odgovaranja na cjenovne signale unutar-dnevnog tržišta električne energije te robusnost odgovora na stohastički element pogreške u predviđanju proizvodnje i promjena uvjeta na tržištu na minutnoj razini koja se očitava od korekcija i osvježavanja predviđanja iz jednog simulacijskog koraka u slijedeći.

Sukladno tome, kroz dugoročni vremenski horizont i kroz kratkoročni vremenski horizont različite su opcije, ograničenja i konfiguracije višeenergijskih sustava razmatrane te su kroz istraživanje i provedene tehno-ekonomske i okolišne analize izvučeni odgovarajući zaključci.

U trenutku provedbe istraživanja u literaturi postoje modeli koji optimiraju pogon kogeneracijskih sustava obično promatranog ili iz perspektive pogona ili iz perspektive

planiranja, no nedovoljno je istraživanja provedeno u području optimizacije trigeneracijskih/višeenergijskih sustava iz okolišnih, ekonomskih i pogonskih aspekata za različite horizonte promatranja koji su ujedinjeno razmotreni kroz razvoj ovog optimizacijskog okvira. Sukladno tome razvijeni je tehno-ekonomski upravljački okvir optimizacije pogona više-energijskih sustava, specifičnije višeenergijskih mikromreža, koji razmatra interakciju s ostatkom sustava i tržištem stavljajući poseban naglasak na fleksibilnost koja se može omogućiti agregacijom i zajedničkim upravljanjem različitih energijskih vektora. Na taj način više-energijski subjekti imaju potencijal pružanja dodatnih usluga ostatku sustava. Dodatne usluge poput regulacije frekvencije i pružanja različitih vrsta rezerve otvaraju nove poslovne mogućnosti te olakšavaju opravdavanje investicija u različite elemente koji su kapitalno intenzivne investicije, ali koji značajno povećavaju učinkovitost i fleksibilnost pogona. Stoga, uz spomenuto povećavanje učinkovitosti proizvodnje energije i pogona, optimalno upravljani više-energijski subjekti poput više-energijskih mikromreža također predstavljaju bitnu opciju za podršku održavanju ravnoteže između potrošnje i proizvodnje na lokalnoj razini. Ravnotežu proizvodnje i potrošnje izazovnije je održavati u uvjetima nesigurnosti proizvodnje te se različitim izvorima fleksibilnosti značajno smanjuje taj problem. Povećanjem dostupne fleksibilnosti povećava se mogućnost daljnje integracije distribuirane proizvodnje energije, prvenstveno iz obnovljivih izvora poput vjetroelektrana i solarnih elektrana. Istovremeno, mogućnost pružanja potpore pogona ostatku sustava kroz različite pomoćne usluge otvara mogućnost za nove poslovne prilike više-energijskim subjektima koje je moguće ostvariti sudjelovanjem na različitim tržištima električnom energijom.

S tim ciljem, doktorski rad opisuje predloženi optimizacijski okvir koji integrira korekcijsko mješovito cjelobrojni linearni optimizacijski model s upravljanjem temeljenim na klizajućem horizontu. Koristeći razvijeni simulacijski okvir rezultati provedenih analiza prate sljedeće najvažnije segmente:

- a) Definicija doprinosa pogonu i fleksibilnosti različitih komponenti višeenergijskih sustava poput električnih dizalica topline, mikro-kogeneracijskih jedinica, trigeneracijskih jedinica za istovremenu proizvodnju električne energije, topline i topline za hlađenje, fleksibilne potrošnje, obnovljivih izvora energije te spremnika energije (toplinske i električne) prilikom izoliranog otočnog pogona simuliranog tijekom dužeg perioda s uključenim troškovima emisija. Određuju se optimalni parametri spomenutih komponenti poput instalirane snage i kapacitete uzimajući u obzir količine neiskorištene topline i propuštene proizvodnje iz energije vjetra koje su

definirani i služe kao indikatori fleksibilnosti. Određene optimalne veličine ukupno instaliranog kapaciteta niza fotonaponskih panela i vjetroagregata se dalje koriste u analizama osjetljivosti koje za određenu konfiguraciju više-energijske mikromreže za cilj imaju odrediti koliko pogonske fleksibilnosti se može postići mijenjanjem parametra različitih elemenata, primjerice kapaciteta spremnika topline ili udjela mikrokogeneracijskih jedinica;

- b) Utjecaj konfiguracije više-energijske mikromreže na fleksibilnost, točnije usporedba i određivanje prednosti i nedostataka decentraliziranih konfiguracija jedinica u usporedbi s centraliziranim konfiguracijama s većim jedinicama. Decentralizirane konfiguracije podrazumijevaju korištenje jedinica na razini kućanstava, odnosno manje instalirane snage. Centralizirane konfiguracije podrazumijevaju korištenje većih, centraliziranih jedinica na razini cijelog naselja. Sve analizirane opcije trebaju u svakom trenutku pružiti dovoljne količine električne energije, toplinske energije i energije za hlađenje iz različitih proizvodnih jedinica različitih karakteristika svim krajnjim potrošačima bez smanjivanja njihove razine udobnosti;
- c) Utjecaj različitih načina modeliranja učinkovitosti i pripadnih aproksimacija, odnosno kvantificiranje mogućnosti da uobičajeno korištene aproksimacije u simulaciji dugoročnog pogona provedenog za potrebe planiranja, ne ostvaruju velike razlike u odnosu na preciznije modele dok u slučaju kratkoročnog planiranja pogona koristeći korekcijsko upravljanje za dnevno sudjelovanje na tržištima el. energije modeli različite razine preciznosti ostvaruje značajne razlike. Aproksimacije korištene u modeliranju imaju kritičnu ulogu u procjeni pogonske fleksibilnosti jer mogu rezultirati pogrešnim zaključcima te je njihov utjecaj bitno odrediti i dati smjernice u kojim slučajevima je opravdano korištenje koje razine preciznosti.
- d) Svi gore navedeni segmenti se ocjenjuju kroz definirane indikatore fleksibilnosti, neiskorištena energija vjetra i suvišno proizvedena toplinska energija, uvažavajući tehno-ekonomska ograničenja različitih konfiguracija višeenergijskih sustava i njihovih pripadnih jedinica. Procjena se radi u izoliranom/otočnom pogonu i paralelnom pogonu s ostatkom sustava gdje je prisutna interakcija sa sustavom preko susretanog mjesta priključka. Mikromreža je upravljana pomoću razvijenog centralnog korekcijskog upravljačkog algoritma temeljenog na pomičnom horizontu čijom se primjenom poboljšava reakcija sustava na pogreške u predviđanju proizvodnje i potrošnje. Reakcija se očituje u minimizaciji pogreške u planiranju pogona više-energijske mikromreže na

tržištu električne energije dan unaprijed temeljena na pogonskim troškovima koji uključuju troškove energije uravnoteženja, troškove emisija te troškove goriva.

Razvoj i implementacija optimizacijskog i upravljačkog algoritma provedena je korištenjem FICO Xpress i Matlab razvojnih okolina. Model koristi stvarne podatke koji se analiziraju i poopćavaju za primjenu za sve konfiguracije više-energijske mikromreže što omogućava bolju evaluaciju modela. Dodatno, sva tehno-ekonomska ograničenja jedinica su proizašla iz pregleda literature i trenutno dostupnih tržišnih komercijalnih modela. Svi korišteni podaci javno su dostupni.

Samo istraživanje je provedeno u tri glavna koraka. Prvi korak uključuje razvoj centralnog mješovito cjelobrojnog linearnog optimizacijskog modela koji se koristiti za optimiranje pogona više-energijske mikromreže. Ovaj korak implementiran je u FICO Xpress razvojnom okruženju. Drugi korak uključuje razvoj upravljačkog okvira koji se nadograđuje na centralni optimizacijski model te koji omogućava učinkovito upravljanje više-energijskom mikromrežom prilikom planiranja nastupa u okruženja dan-unaprijed tržišta električne energije te njenog rada u stohastičkom okruženju unutar-dnevnog tržišta električnom energijom. Ovaj segment razvijen je u Matlab razvojnoj okolini unutar kojega se integrirao model razvijen u prvom koraku. Treći korak zaokružuje istraživanje kroz razmatranja kako više-energijski sustavi utječu na pogon ostatka elektroenergetskog sustava promatran kroz točku susretnog mjesta priključenja. Ovaj segment je modeliran kao nadogradnja na simulacijski okvir koji integrira prva dva koraka.

Sukladno gore navedenim trima koracima provedenog istraživanja, doprinosi provedenog istraživanja opisani kroz doktorsku disertaciju s naslovom „Modeliranje i evaluacija fleksibilnih više-energijskih sustava u niskougličnom okruženju“ su:

- Mješovito cjelobrojni linearni optimizacijski model za planiranje i estimaciju dugoročne fleksibilnosti više-energijskih mikromreža;
- Vođenje fleksibilnih više-energijskih mikromreža temeljeno na korekcijskom planiranju kratkoročnog optimalnog pogona jedinica s pomičnim horizontom;
- Model za određivanje potencijala i vrijednosti fleksibilnosti usluga više-energijskih mikromreža u niskougličnom elektroenergetskom sustavu;

Disertacija ujedinjuje opis teorijske pozadine i korištenih matematičkih modela s ostvarenim rezultatima i praktičnim rezultatima i indikatorima. Kroz disertaciju su opisani



doprinosi te su konkretno povezani s različitim dijelovima objavljenih radova koji ih definiraju i pojašnjavaju.

**Ključne riječi:** više-energijski sustavi, mikromreže, fleksibilnost, operacijska istraživanja, linearna optimizacija

## CONTENTS

1.	Introduction .....	1
1.1.	Background and motivation.....	1
1.2.	Problem statement.....	2
1.3.	Objective of the Thesis .....	3
1.4.	Structure of the thesis.....	4
2.	Multi-Energy Systems.....	5
2.1.	Multi-energy systems general aspects .....	5
2.2.	Multi-energy microgrids (MEM).....	8
2.3.	Flexibility of multi-energy systems .....	8
3.	Power System Modelling Aspects .....	13
3.1.	Unit commitment .....	15
3.2.	Duality theory .....	19
3.3.	Receding horizon scheduling.....	22
4.	Main Scientific Contribution of the Thesis.....	26
1)	A new long-term optimization model of multi-energy systems .....	27
2)	A new receding horizon corrective scheduling algorithm for short-term optimal operation of multi-energy systems.....	27
3)	A new model for defining the value of flexibility of multi-energy systems in the low-carbon power system operation .....	28
5.	List of Publications .....	29
6.	Author’s Contributions to the Publications.....	31
7.	Conclusion and Future Directions.....	34
	Bibliography.....	35
	Publications .....	45
	Publication 1 – Corrective receding horizon scheduling of flexible distributed multi-energy microgrids.....	46
	Publication 2 - Adaptive Control for Evaluation of Flexibility Benefits in Microgrid Systems .....	64
	Publication 3 - Defining Key Parameters of Economic and Environmentally Efficient Residential Microgrid Operation .....	83
	Publication 4 - Modelling Aspects of Flexible Multi-Energy Microgrids .....	94

---

Publication 5 - Model for Defining the Potential and Value of Multi-Energy Microgrid Services to the Low Carbon Power System.....	102
Publication 6 - Model Predictive Control for Scheduling of Flexible Microgrid Systems .....	109
Publication 7 - Beijing Subsidiary Administrative Center Multi- Energy Systems: An Optimal Configuration Planning – under review.....	130
List of Abbreviations.....	140
List of Figures and Tables.....	141
Biography .....	142
Životopis.....	146

# 1. INTRODUCTION

The electric power sector is currently going through a transition accelerated by the integration of renewable energy sources. The environmental impacts the modern society is producing are being mitigated through an attempt to reduce the greenhouse emissions from all sources, namely power and energy, industry and transport sectors [1]. The massive deployment of variable and limitedly predictable electricity generation from renewable energy sources (RES) [2] requires power system planners and operators to reevaluate the way power systems are planned, designed and operated since passive integration of these sources close to the consumers might result in significant over investments driven by needed upgrades at the distribution grid level [3], [4]. Considering this challenge, the optimization methods and algorithm are used in many segments of the process. Equally important is modelling and evaluation of multi-energy systems that can provide a solution to the RES integration at the local level [5]. This thesis proposes a modelling framework to analyze the impact of different elements on the long-term operation and design of multi-energy systems and a novel corrective scheduling algorithm for its daily operation.

## 1.1. Background and motivation

Integration of renewable energy sources is largely driven by governmental incentives, especially the small scale RES on a small domestic scale to increase the share of zero emission generation [6], [7]. As its share increases, the concept of incentives becomes unsustainable and the need to develop new approaches becomes inevitable. The European Union goals [8] are pushed towards the clean production of energy [9] and inclusion of all consumers in the power system operation. New rules that make it easier for individual consumers to produce, store or sell energy. Traditionally, any generation mismatch caused by variations in RES generation had to be compensated by dispatchable generating units [10]. Today, the system development is shifting towards acquiring the flexibility from the consumers, ranging from flexible demand to distributed generation [11]. Controllable and non-controllable RES technologies at the low-voltage level cover a wide range of units: PV (photovoltaic units), WPP (wind power plants), EHP (electric heat pumps),  $\mu$ CHP (micro combined heat and power units), HS (thermal energy storage), battery electrical energy storage (BEES) etc. Aggregating these technologies creates a market entity capable of not only isolated operation, but also controllable interaction with the electric system in grid-connected mode [12]. Distributed systems need to be integrated within

the rest of power grid's control system by means of aggregation and market mechanisms. Although ideas of virtual power plants and standalone microgrids are not new [13], there is still lack of mathematical models capable of representing behavior and scheduling of such clusters of units. A good model and simulation framework must provide robust response of a multi-energy system to fluctuations of the connected renewable energy sources production and, if needed, must ensure its stand-alone operation.

## 1.2. Problem statement

Aggregating groups of consumers of different energy vectors and generating units at a single location with centralized control is known as the concept of multi-energy microgrid (MEM). However, if those potentially flexible producers and consumers do not have the ability to balance the variability and uncertainty of their renewable energy sources production within them, from the system perspective, they are seen as a source of imbalances and potential problems in maintaining the equilibrium of production and consumption. One of the key characteristics of the microgrid operation that needs to be achieved is flexibility. Main goal of this research is to quantify this ability of MEM components to provide flexibility, as well as the impact different energy vectors have on overall flexibility and to estimate the effect the configuration of MEM and modelling concepts have on flexibility indicators. This flexibility is analyzed from two perspectives, defining two operating principles: independently from the distribution grid in island operation and connected, interacting and responding to signals from the upstream system. When MEM is connected to the upstream power system its flexibility manifests as capability to alleviate variability and uncertainty in local production of renewable energy sources and demand. On the other hand, when operating isolated from the rest of the system, the main flexibility indicator is minimum energy curtailment while ensuring the satisfaction of all demand (electrical, heating and cooling). The thesis presents a MILP (Mixed Integer Linear Programming) model applied under corrective receding horizon approach in order to capture the value of integrating multiple energy vectors, their optimal operation and their flexibility potential for low carbon energy system.

In the current moment there are models aimed at optimizing cogeneration system operation, but not enough research is carried out for the optimization of trigeneration/multi-energy systems from both environmental, economic and operational aspects all provided by the single optimization framework.

The aim of the research presented in this thesis is to develop a techno-economic operational optimization framework for multi-energy systems, specifically multi-energy microgrids, which considers the interaction with the upstream energy systems and markets specifically emphasizing the flexibility that can be made available by aggregating and coupling of multiple energy vectors. In this way multi-energy entities have the potential of providing power system services, such as frequency regulation, different forms of reserves (primary and secondary reserve), investment deferral and network capacity support. Hence, optimally controlled multi-energy entities (e.g. microgrids) are an attractive option to support the demand-supply balancing task at the local level enabling the increased intermittent generation of mainly wind and solar. At the same time, capability to offer to the upstream system beneficial behavior pattern that follows the announced day-ahead plans provides potential business case for multi-energy systems. All these aspects are investigated through the development of an integrated simulation framework.

### **1.3. Objective of the Thesis**

Proposed research is oriented towards quantification and unlocking of flexibility capacities of multi-energy systems [14], in particular multi-energy microgrids. It is focused on both the planning phase, including dimensioning of elements through long-term operation simulation, and short-term operational phase that includes market participation simulation under uncertainty. The objective of the research is to formulate mathematical optimization model and central control framework capable of analyzing and improving operation of different compositions of multi-energy systems and measure the effect of different modelling aspects and approximations. This is done under the market environment using flexibility indicators. Furthermore, the developed model described in the thesis enables evaluation of potential system benefits of the proposed coordinated and coupled operation of all multi-energy system elements observed from one connection and communication point – point of common coupling (PCC).

Hypothesis of the research assumes that the proposed optimization framework improves flexibility indicators of the multi-energy microgrid operation. It improves the flexibility in both the planning and operational phase. Furthermore the proposed optimization framework can increase local integration potential of renewable energy sources thus reducing emissions and enabling successful market participation.

Scientific contribution of this thesis shaped from the conducted research is as follows:

- Mixed integer linear optimization model for planning and estimating long-term flexibility aspects of multi-energy microgrids;
- Receding horizon corrective scheduling based algorithm for optimal short-term operation of flexible multi-energy microgrids;
- Model for defining the potential and value of flexibility services of multi-energy microgrids to low carbon power system operation.

#### **1.4. Structure of the thesis**

The thesis is organized as follows. Chapter 2 provides an introduction and review of related work in the field of multi-energy systems modelling. The emphasis is placed on the flexibility potential of multi-energy systems. Chapter 3 briefly reviews optimization and control methods and concepts used in the development of the optimization framework while Chapter 4 presents the scientific contributions of the thesis. Chapter 5 provides a list of all related publications that contain different segments of the research contributions is given. The author's contributions to the publications included in the thesis are summarized in Chapter 6. Finally, Chapter 7 concludes the thesis and provides a potential direction of the future research.

## 2. MULTI-ENERGY SYSTEMS

When considering the transition toward a sustainable, low-carbon energy future the challenge of the current energy grids primarily based on variable, distributed renewable energy sources needs to be solved. In that regard, multi-energy systems may provide the necessary flexibility to tackle the issue of uncertain and variable RES output and help preserving the balance between the supply and the demand. New methods and simulation tools are necessary to derive suitable models that support this transition towards carbon-free power systems.

Traditionally, the flows of different energy vectors have been decoupled and currently there is a need for dedicated tools and optimization platforms to model grid and infrastructure of multi-energy carriers and multi-energy systems in detail.

### 2.1. Multi-energy systems general aspects

In multi-energy systems the electricity, heating, cooling, fuels and transportation energy vectors interact with each other at different levels from within the local district to the city scale. This presents an opportunity to increase technical, economic and environmental performance compared to classical systems where the flows of these energy vectors are observed through separate sectors independently [15]. The interactions between these energy vectors have always partially existed, but different energy sectors have been decoupled from both operational and planning viewpoints. For example, electricity, heating and gas networks interact through distributed generation, such as combined heat and power units, electric heat pumps (EHP) or air conditioning units (AC) [16]. Similarly, the interactions between the transport and electricity sectors have gained momentum due to development of electric vehicles (EV) [17], [18], [19], [20]. Electrification of heat and transport within the zero-carbon grids [21] and development of suitable distributed energy markets [22] require a development of an integrated MES framework.

Expanding the system boundary beyond one system, e.g. electrical or heating as the most common study cases, brings a new perspective into optimization and evaluation of such systems and enables unlocking of benefits such as: i) increase in the conversion efficiency and utilization of primary energy sources; ii) optimal deployment of both centralized and decentralized resources at a system level through optimal market interactions to respond to volatile electricity prices in RES production rich energy systems; iii) increase of the energy



system flexibility by allowing units such as EHP or EV to participate in power system balancing services. The manifold perspectives and complexity typically related to MES can be categorized on spatial, multi-service, multi-fuel and network perspectives [5].

*Spatial perspective* points how MES can be conceived and modelled at different levels of aggregation from the building level to the district and the regional level, depending of the purpose of the study. The smallest block, a single MES entity, to the wider, region-scale, can be represented by a general energy hub model [23]. A general model covers all types of power inputs  $(P_\alpha, P_\beta, \dots, P_\omega)$  and outputs  $(L_\alpha, L_\beta, \dots, L_\omega)$  in vectors  $\mathbf{P}$  and  $\mathbf{L}$  connected with matrix  $\mathbf{C}$  called the coupling matrix thus creating a multi-input multi-output power conversion (2.1). Mathematically, this matrix describes mapping of the powers from the input to the output of the converter and each factor related to one particular input and output. So-called dispatch factors have to be introduced that define the dispatch of the total input to the devices (converters) with multiple outputs. This approach can be related to any multi-energy system description and can be considered as a general case of aggregation.

$$\underbrace{\begin{pmatrix} L_\alpha \\ L_\beta \\ \vdots \\ L_\omega \end{pmatrix}}_{\mathbf{L}} = \underbrace{\begin{pmatrix} C_{\alpha\alpha} & C_{\beta\alpha} & \dots & C_{\omega\alpha} \\ C_{\alpha\beta} & C_{\beta\beta} & \dots & C_{\omega\beta} \\ \vdots & \vdots & \ddots & \vdots \\ C_{\alpha\omega} & C_{\beta\omega} & \dots & C_{\omega\omega} \end{pmatrix}}_{\mathbf{C}} \underbrace{\begin{pmatrix} P_\alpha \\ P_\beta \\ \vdots \\ P_\omega \end{pmatrix}}_{\mathbf{P}} \quad (2.1)$$

*Multi-service perspective* means focuses are on provision of multiple outputs from various energy vectors, since the possibility of coupling them opens a path to improving the performance from techno-economic and environmental perspectives. The most important multi-generation units are CHP [25] and CCHP [26] units. This concept is schematically illustrated in Figure 2.1.

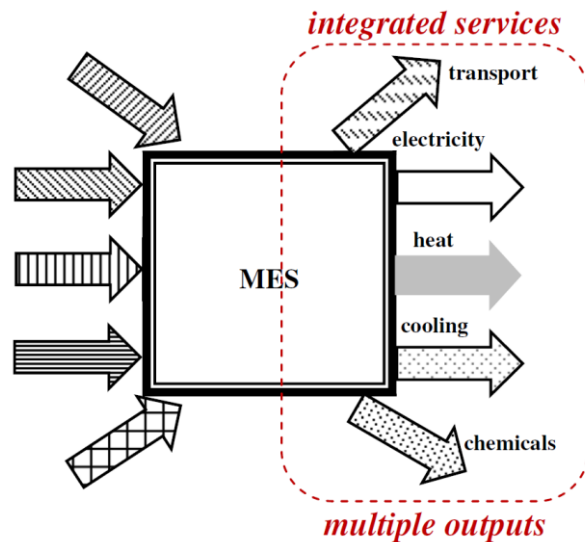

Figure 2.1 Schematic illustration of the multi-service perspective. Figure adapted from [5].

*Multi-fuel perspective* highlights how different types of fuels for both electric and heat energy can be integrated for an optimal supply and in the same time provide multi-service capabilities in a MES. Figure 2.2 shows an example of a multi-energy system model that incorporates all relevant energy vector flows and production from the distributed generation sources. This aspect is becoming increasingly important with the rising share of RES electricity production and their interaction with district heating networks [28].

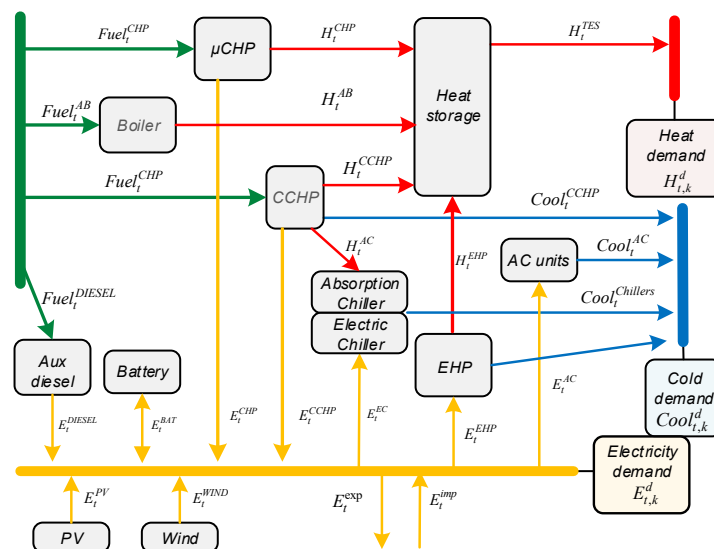

Figure 2.2 Example of multi-generation system simplified scheme for trigeneration of electricity, heating and cooling and network interactions

*The network perspective* manifests in terms of facilitating the development of multi-energy systems inside the wide energy system allowing their interaction in order to minimize

cost and/or environmental impact. This interaction is naturally observed through flows of various energy vectors and market participation, both aiming to reduce costs and CO<sub>2</sub> emissions [29].

## **2.2. Multi-energy microgrids (MEM)**

Aggregating groups of loads and generators at the same location with centralized control is known as the concept of microgrids. A microgrid can be interpreted as a low-voltage or a medium-voltage distribution system with various distributed energy resources (distributed generation, storage, and controllable loads), which is controlled in a coordinated way and can operate in islanded mode if needed. Microgrid often incorporates all the segments and units of multi-energy systems [30] and can generally be regarded as a subset of a wider term multi-energy systems. The same design and optimization principles as in multi-energy approach can be applied to microgrids but the microgrid approach often considers the control architectures and methods [31], [32] which means the microgrid concept tends to be more specifically oriented with less aggregation and generalization included. Inevitably, the flexibility potential of production units and consumers is aimed to be unlocked and utilized. However, if those flexible producers and consumers do not have the ability to balance the variability and uncertainty of their RES production, from the system perspective they are regarded as a source of imbalances and potential problems in maintaining the equilibrium of production and consumption. The simulation and optimization of multi-generation microgrids in the design and operation phase is therefore important [32], [33].

An integrated model able to simultaneously provide support in the design phase for the long-term goals and apply effective control algorithm for short-term operation goals can utilize flexibility in a wide range of cases. Following on this, a simulation framework was developed providing manifold insights into the multi-energy microgrid operation. As a part of this thesis a linear model with convergence and guaranteed optimality was developed and the benefits compared to other approaches [34], [35], [36] were demonstrated.

## **2.3. Flexibility of multi-energy systems**

Flexibility aspects are gaining importance in the modern power systems. Power system flexibility is becoming a key characteristic in accommodating the increasing share of variable generation. Technically, it can be defined as the ability to respond to changes in demand/

generation equilibrium. In economic sense, flexibility can be defined as the capability of a single market subject to quickly adjust to the most current market signal and follow the scheduled plan of exchange. All power systems inherently have a certain flexibility level; with increase of unpredictable and variability RES these values are required to be much higher. Lack of system flexibility can be manifested in frequency deviations which can lead to load shedding, deviations from contracted exchanges, wind curtailment, higher price volatility.

The introductory chapter already stated the idea that a fully renewable energy system is the tendency for the future. This should be put hand in hand with the latest strategic goal of the EU that large share of energy production should be in the hands of final consumers [8]. These goals cannot be achieved without a systematic approach to planning of available system flexibility. This also means that a significant share of operational flexibility, to alleviate issues of renewable generation integration, will need to come from the distribution level through integration of technologies capable of responding to different price signals. Evaluating the potential flexibility benefits of different technologies at the distribution and district level [37] provides a valuable step toward a successful integration of renewable energy sources in the distribution level that will complement the low-carbon technologies on a larger scale [38]. Flexibility is relevant to many aspects of the distribution system operator planning process. Figure 2.3 shows the traditional processes involved in power system planning are focused on ensuring sufficient generation capacity to meet demand during peak conditions (orange boxes). These are based on long range forecasts and different resource expansion options. These options evaluate the transmission network reliability and capacity adequacy to accommodate planned production expansion and all of the demand. The process market in orange does not plan for flexibility and operational aspects while the new processes marked in green plan for the flexibility at the planning stage to ensure that system can deliver enough flexibility at all points of its operation. Therefore the planning decisions are enhanced with the operational analysis which in its core has system flexibility.

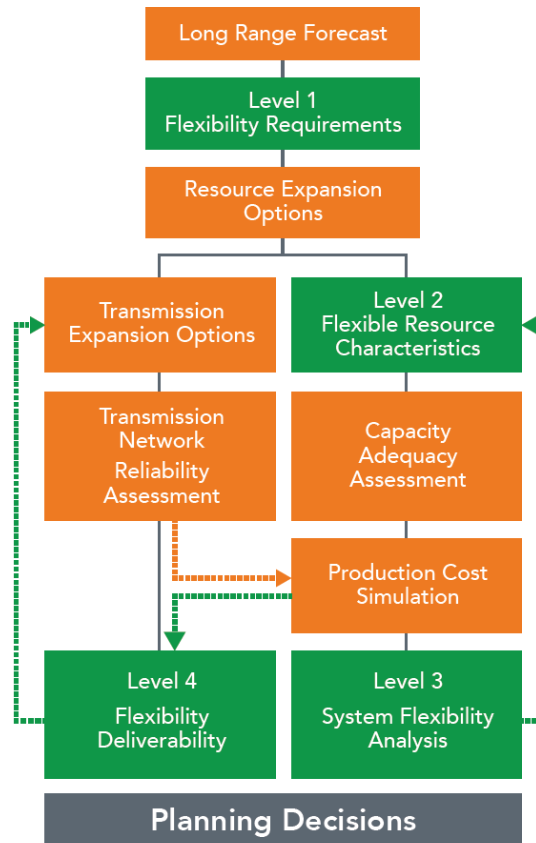

Figure 2.3 Power system flexibility planning process – traditional process (in orange) and modified process (in green). Figure adapted from [43].

Microgrid flexibility can be observed by means of following the predefined exchanges of energy with the rest of the distribution system through a point of common coupling (PCC) [39]. Scheduling microgrid operation is subject to imperfect forecasting of local renewable energy sources or demand. However, if these imbalances are compensated at the local level microgrid entities become energy flexible nodes capable of providing multiple flexibility services to the upstream system [40].

Additionally, power system flexibility is becoming a key characteristic in answering the increasing share of variable generation [41], to respond to changes in demand/generation equilibrium [42] and to adapt to most actual market situation and follow the scheduled plan of exchange [43]. All power systems inherently have a certain flexibility level but with increase of unpredictable and variability RES required values are much higher. The current system flexibility requirements are mostly based on deterministic calculation [44], [45] which increases the system costs does not fully account for potential flexibility stemming from the distribution level.

Traditionally, all the imbalance between the production and consumption had to be compensated by centralized units, however with the advent of new technologies ( $\mu$ CHP, electric vehicles, flexible demand, electric heat pumps etc.) new flexibility potential can be unlocked on the local, distribution level [46]. Concepts of virtual power plants [47] and microgrids [12] are well known, yet there is still a lack of integral approach to assessment of all energy vector potential on a microgrid level. This particularly applies to terms of interaction between the MEM and the rest of the system that tackles the operational aspects of multi-energy systems (MES) also providing some valuable inputs for planning, unit optimal sizing, operation and business approaches.

While integration of batteries and electric vehicles is widely researched for their capability to provide flexibility services [48], it is equally important, to unlock and enable the already existing flexibility potential in the distribution-level energy systems. In this context multi-energy systems [49] and multi-energy microgrids become increasingly relevant since they couple different units and shift between energy vectors. Such systems have the capability of providing required services for the consumer without diminishing the comfort of final users and, on the other hand, to provide response to system requirements on different and multiple time frames [50], [51]. There are significant benefits by means of adaptive dispatch and coordination of multi-energy systems in active distribution networks [52] and efficient control will be an integral part of successful development of such systems.

In order to utilize provision of price-driven services from multi-energy system, or other potentially flexible units on the distribution side, they need to be aggregated into a single entity since such market participation increases both market visibility, capability to compete in multiple market and, correspondingly, their benefits [53]. Aggregation within virtual power plants (VPP) is usually composed of conventional and renewable energy units [54], [55]. The inability to forecast RES generation within the VPP defines participation of such entity in the market and the need to correct the VPP position. Flexible units such as energy storage are put in service of minimizing the level of variability and uncertainty announced ahead of realization of production [56]. Recent research focuses on robust or risk-based bidding strategies to overcome issues of planning for uncertain production realization [57]. However these approaches can lead to over-conservative solutions and suboptimal operating points.

Already single district multi-energy unit can be regarded as VPPs, since it is usually composed of several different units [58]. This means the MEM concept described in the thesis provides an additional level of flexibility compared to the commonly used VPP models.

Cooperation of these units results in both economic savings and environment impact reduction [59]. When grouping different multi-energy units, the value of multiple energy vector shifting becomes even more highlighted [60].

On a district/microgrid level, the local heat and cooling demands are predictable and do not contribute significantly to uncertainty and variability. Unlike local RES production which is hard to predict. In addition, heat and cooling have a significant amount of inertia inherent to the process (slower change of parameters, e.g. temperature) meaning that their moment-to-moment load balancing requests are less strict. The value of re-dispatching capability is recognized through the concept of MES profitability maps described in [61], however with no optimization through a rolling horizon using re-dispatching capabilities. Altogether, there is no comprehensive operational and environmental analysis of multi-energy systems in the literature that could provide insights into unlocking their additional flexibility benefits.

The thesis defines a comprehensive and unified techno-economic and environmental modelling and optimization framework for the operational and planning evaluation of flexibility of different multi-energy systems [27],[62]. The concept of flexibility, in this thesis is defined from twofold point of view and analyzed for different configurations of multi-energy systems:

- a) planning flexibility –capability to influence potential flexibility of the modelled system in the long run of participation in the day-ahead energy market through optimal selection and dimensioning of elements that will achieve the best flexibility indicator values, minimum costs and minimal environmental impact;
- b) operational flexibility - capability to respond to price signals of intraday market in close to real time [63] and robustness in response to stochastic element of forecast error and capability to adapt to changing market conditions;

### 3. POWER SYSTEM MODELLING ASPECTS

Mathematical representation of all power system segments has a great value in all the research and application. The simulation models in the field of power system modelling and optimization need to combine and improve different theories and physical principals' representations to test and prove new concepts and models.

The developed optimization framework is developed with the purpose to optimize the real-time performance of the multi-energy system on a long time operational horizon. It calculates the optimal outputs which are forwarded to the local control layer in a form of desired power outputs which are transferred to currents and voltages. The framework assumes the local layer is able to fulfill all the requirements and efficiently follow the upper control layer. The control layer implemented is a centralized control but it can also be implemented as a distributed structure [64]. The framework minimizes the long-term cost through a hierarchical control structure that consists of two main layers, the local layer and the upper optimization layer.

On the figure below (Figure 3.1 [65]) physical and communication structure of a microgrid can be seen. The upper part of the figure represents physical microgrid elements. It can be seen the microgrid is connected to the distribution system. The optimization layer reaches the decision of optimal economic operation based on the current state of the system, forecasted outputs and expected energy prices. The result is of operational trajectory including an array of optimal microgrid setpoints in the coming time periods and energy bids in the market. Following the upper optimization layer the lower control layer controls all microgrid elements in order to follow the optimal setpoints [65]. The local control constantly collects data on actual states of microgrid elements and propagates it to the microgrid optimization layer. The optimization layer derives the long-term operational schedule based on forecasted values of the uncertain parameters output of local renewable energy sources and load. The optimization framework operates under the market conditions and therefore the optimization layer deploying the receding horizon corrective controls looks 24 hours ahead and considers uncertain parameters using the detailed mathematical model of the physical microgrid.



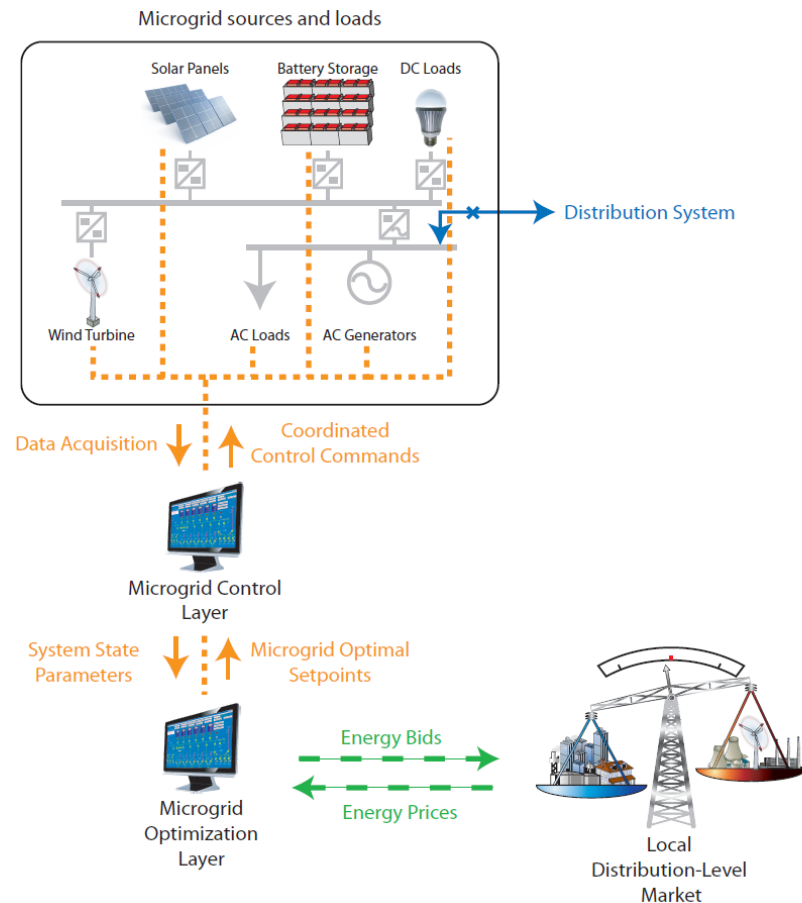

Figure 3.1 Microgrid physical and communication structure showing energy flows with full lines and information and control flows with dashed. Figure adapted from [65].

The optimal trajectory is a set of variable for different setpoints of the time horizon divided into 15-minute discrete intervals. This trajectory is given to the control layer that uses a detailed representation of the microgrid elements. The control layer runs continuously in a closed loop to match the imposed trajectory setpoints making the necessary adjustments in real time. All values within the microgrid are constantly measured and fed as input data alongside updated forecasts. A very good representation of this process and the mechanics of the interaction between the layers can be found in [65].

The basic structure with the most important interactions of the developed optimization framework can be seen on figure below (Figure 3.2) which shows the optimization layer and the local control layer both interacting with the multi-energy microgrid.

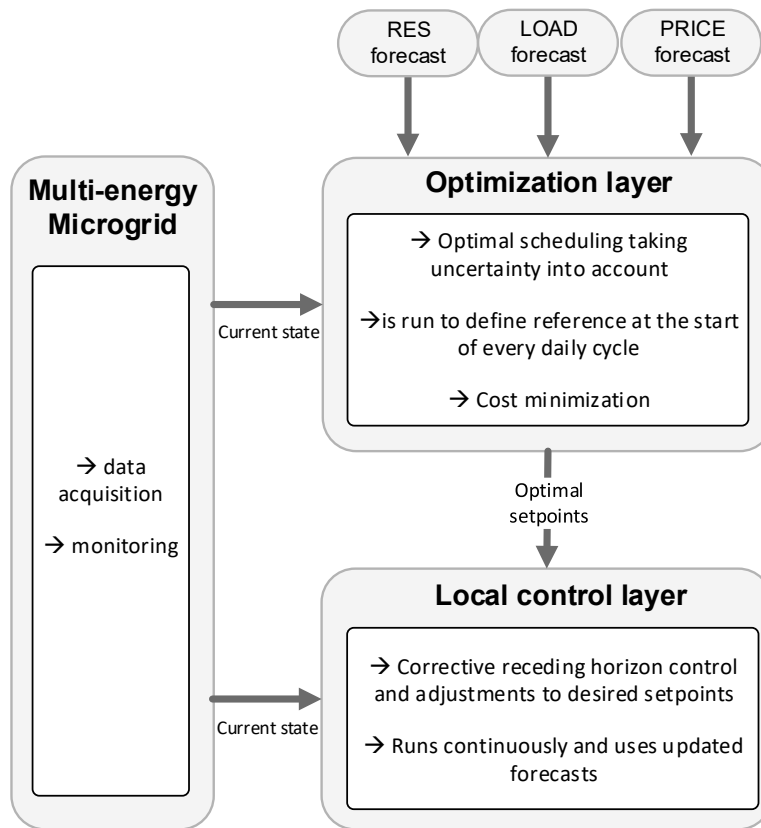

Figure 3.2 Optimization framework utilizing the hierarchical control of two layers

The developed optimization layer incorporates three main segments: 1) detailed mathematical model for the optimization of multi-energy microgrid; 2) model extension for defining the value of flexibility of multi-energy systems in the low-carbon power system operation; 3) receding horizon corrective scheduling algorithm for optimal operation.

These segments use different power system modelling aspects at its base that are described in this chapter. The first segment, mathematical model, represents a unit commitment model of the different microgrid elements that schedules the operation. The second segment extends the model using the duality theory to capture a wider scope of possible cases. Finally, third segment uses the control theory based on the model predictive control to achieve the receding horizon corrective scheduling.

### 3.1. Unit commitment

The aim of the basic formulations of unit commitment problems which are generally written as mixed integer linear problems is to optimize the system operations targeting and modelling a series of external factors that affect electrical power generation schedules. These factors include ramping capacity, reserve requirement, transmission capacity, fuel constraints,

emission constraints, minimum on-time, minimum off-time, startup/shutdown cost etc. Generally, the unit commitment problem needs to optimize the on/off statuses of the generators to meet the required load levels but since the electric power generation is not an isolated component in the power system, the real-time dispatch levels are also subject to demand changes, production changes, transmission lines conditions.

A generic unit commitment objective function (3.2) consists of two components resembling the two-stage decision process of the unit commitment problem [66]. The first component is defined by the day-ahead decision which primarily include the startup and shutdown decisions of the units. If it is assumed no rescheduling is done in the next-day operation then the second component cost comes from the actual fuel cost to produce the energy and eventual load-shedding when the demand cannot be satisfied entirely.

$$\min \sum_{g \in G} \sum_{t \in T} (SU_g \cdot v_g^t + SD_g \cdot w_g^t) + \sum_{g \in G} \sum_{t \in T} F_f(p_g^t) + VOLL \cdot \sum_{i \in N} \sum_{t \in T} \delta_i^t \quad (3.2)$$

$SU_g$  is startup cost of unit g

$SD_g$  is shutdown cost of unit g

$F(\cdot)$  is fuel cost function of unit g - quadratic  $F_g(p) = a + bp^t + c(p_g^t)^2$

$p_t^g$  is the power generation of unit g at time t

$VOLL$  is the value of loss load [EUR/MWh]

$\delta_{it}$  is load loss at bus i at time t

In the fuel cost function coefficients are positive but the resulting quadratic mixed integer problem is hard to solve and therefore the piecewise linear approximation is applied which returns precise enough results and lowers the computation burden [68]. Usually the sum of squares technique is used to substitute the  $F_g(t)$  with the summation of linear segments (3.3). Figure 3.3 shows the graphical depiction [69].

$$\sum_{k=1}^K \Delta_k \lambda_k \quad \text{s.t.} \quad p_g = \sum_{k=1}^K \Delta_k \lambda_k \quad \text{and} \quad \sum_{k=1}^K \lambda_k = 1 \quad \text{for} \quad \lambda_k \geq 1, k = 1, \dots, K \quad (3.3)$$

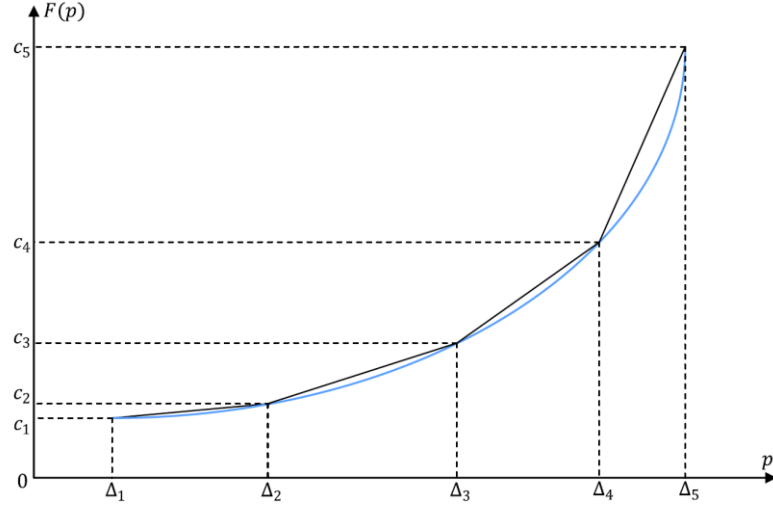

Figure 3.3 Piecewise linear approximation of the fuel cost function.

The typical set of constraints addresses the different operational characteristics of units and different service requirements. These include:

- a) *Unit commitment constraints* that indicate the shortest on time and shortest off duration of a generator because the generator cannot be started or shut down in arbitrary or consecutive moments (Equation (3.4)).

minimum on constraint:

$$u_g^t - u_g^{t-1} \leq u_g^\tau \quad \forall g \in G, t \in T, \tau = t, \dots, \min\{t + L_g - 1, |T|\}$$

minimum off constraint:

$$u_g^{t-1} - u_g^t \leq 1 - u_g^\tau \quad \forall g \in G, t \in T, \tau = t, \dots, \min\{t + l_g - 1, |T|\} \quad (3.4)$$

startup action constraint:

$$v_g^t \geq u_g^t - u_g^{t-1} \quad \forall g \in G, t \in T$$

shutdown action constraint:

$$w_g^t \geq -u_g^t + u_g^{t-1} \quad \forall g \in G, t \in T$$

where:

$u_g^t$  commitment decision;  $u_g^t = 1$  if online

$L_g$  the minimum on duration

$l_g$  the minimum off duration

$|T|$  the duration of a planning horizon

$v_g^t$  binary variable for startup action of a generator  $g$  at time  $t$

$w_g^t$  binary variable for shutdown action of a generator  $g$  at time  $t$

- b) *Generator constraint* limits the production of the generator between its minimum generator limit and maximum generator limit (Equation (3.5)). Additionally, the generator change of

power between two adjacent time periods is limited with the ramping constraints (Equation (3.6)) [67].

minimum on constraint:

$$u_g^t - u_g^{t-1} \leq u_g^\tau \quad \forall g \in G, t \in T, \tau = t, \dots, \min\{t + L_g - 1, |T|\}$$

minimum off constraint:

$$u_g^{t-1} - u_g^t \leq 1 - u_g^\tau \quad \forall g \in G, t \in T, \tau = t, \dots, \min\{t + l_g - 1, |T|\} \quad (3.5)$$

startup action constraint:

$$v_g^t \geq u_g^t - u_g^{t-1} \quad \forall g \in G, t \in T$$

shutdown action constraint:

$$w_g^t \geq -u_g^t + u_g^{t-1} \quad \forall g \in G, t \in T$$

ramping constraint:

$$u_g^t - u_g^{t-1} \leq u_g^\tau \quad \forall g \in G, t \in T, \tau = t, \dots, \min\{t + L_g - 1, |T|\} \quad (3.6)$$

m:

- c) *Transmission system constraints* casts the Kirchhoff's current and voltage laws in a nodal way and a DC power flow approximation is used.
- d) *Emission constraints* addresses the consideration of most commonly CO<sub>2</sub> emissions on a system wide level. The emissions highly depend on the fuel type of the generator unit. Total emission over a planning horizon can be formulated as (3.7) [70].

$$\sum_{g \in G} \sum_{t \in T} (F_{ge}(p_g^t) u_g^t + SU_{ge} \cdot v_g^t + SD_{ge} \cdot w_g^t) \leq E^{\max}$$

where:

$F_{ge}(\cdot)$  emission function of unit  $g$

$SU_{ge}$  startup mission of unit  $i$  at time  $t$

$E^{\max}$  system emission limit

(3.7)

- e) *Unserved energy constraints* impose a performance which keeps the total load losses within the predefined allowable margins.

$$E\left(\sum_{i \in N} \delta_{it}\right) \leq \varepsilon_t, \quad \forall t \in T$$

where:

$E(\cdot)$  function of expected load loss

$\varepsilon_t$  allowed load loss margin

(3.8)

Furthermore, constraints of voltage relations and reactive power, and constraints regarding the primary and secondary reserves can also be included.

The usual parameters of a generic generator unit are shown in the table below (Table 3.1) [71].

Table 3.1 Generator parameters and costs – typical values for a thermal power plant unit

Parameter	Units	Values
Generator installed capacity	[MVA]	100
Minimum power	[MW]	20
Maximum power	[MW]	95
Spin reserve limits	[MW]	10
Min on time	[h]	2
Min off time	[h]	2
Ramp-up rate	[MW/h]	30
Ramp-down rate	[MW/h]	20
Startup cost	[EUR]	800
Shutdown cost	[EUR]	800
Fuel cost coefficient $a$	[EUR]	6,78
Fuel cost coefficient $b$	[EUR/MWh]	12,88
Fuel cost coefficient $c$	[EUR/MWh <sup>2</sup> ]	0,05

Regarding the unit commitment adaptation to a specific need, we have adopted and modified the basic model to include all the relevant elements of a multi-energy system and renewable energy generation balancing between the model generality and model precision. Finally, we have achieved satisfactory computation time for a real time application and achieved very good accuracy. Additionally, we have extracted interesting conclusions regarding the importance of certain approximations that are commonly used and measured their impact [27], [72].

### 3.2. Duality theory

Optimization is inherent part of the design, planning, operation, and control of power systems. For a given mathematical programming optimization problem (the primal problem) there exist an associated dual problem. The difference between the optimal values of solution of primal and dual problems is called duality gap. The duality theory allows solving such problems when the primal problem is hard to solve but the dual can be solved easily through

the recasting of the problem through the Karush-Kuhn-Tucker (KKT) optimality conditions [73].

The general problem of mathematical programming can be stated as in (3.9) [74].

$$\begin{aligned} \min_{x_1, \dots, x_n} z &= f(\mathbf{x}) \\ \text{s.t. } \mathbf{h}(\mathbf{x}) &= \mathbf{0} \\ \mathbf{g}(\mathbf{x}) &\leq \mathbf{0} \end{aligned} \quad (3.9)$$

Where  $\mathbf{x} = (x_1, \dots, x_n)^T$  is the vector of decision variables,  $f(\cdot)$  is an objective function  $f: \mathbf{R}^n \rightarrow \mathbf{R}$  and  $\mathbf{h}(\mathbf{x}) = (h_1(x), \dots, h_l(x))^T$  are the equality constraints and  $\mathbf{g}(\mathbf{x}) \leq (g_1(x), \dots, g_m(x))^T$  are inequality constraints. If any of the functions is nonlinear the whole problem becomes nonlinear. For a given linear programming problem (3.10) the dual problem is (3.11):

$$\begin{aligned} \min_{\mathbf{x}} z &= \mathbf{c}^T \mathbf{x} \\ \text{s.t. } \mathbf{A}\mathbf{x} &\geq \mathbf{b} \\ \mathbf{x} &\geq \mathbf{0} \end{aligned} \quad (3.10)$$

$$\begin{aligned} \max_{\mathbf{y}} z &= \mathbf{b}^T \mathbf{y} \\ \text{s.t. } \mathbf{A}^T \mathbf{y} &\geq \mathbf{c} \\ \mathbf{y} &\geq \mathbf{0} \end{aligned} \quad (3.11)$$

where  $\mathbf{y} = (y_1, \dots, y_m)^T$  are called dual variables.

The main method used with such problems are the KKT conditions. In general form the vector  $\mathbf{x} \in \mathbf{R}^n$  satisfies the KKT conditions for the problem (3.9) if there exists vectors  $\boldsymbol{\mu} \in \mathbf{R}^m$  and  $\boldsymbol{\lambda} \in \mathbf{R}^l$  such that:

$$\nabla f(\mathbf{x}) + \sum_{k=1}^l \lambda_k \nabla h_k(\mathbf{x}) + \sum_{j=1}^m \mu_j \nabla g_j(\mathbf{x}) = \mathbf{0} \quad (3.12)$$

$$h_k(\mathbf{x}) = 0, \quad k = 1, \dots, l \quad (3.13)$$

$$g_j(\mathbf{x}) \leq 0, \quad j = 1, \dots, m \quad (3.14)$$

$$\mu_j g_j(\mathbf{x}) = 0, \quad j = 1, \dots, m \quad (3.15)$$

$$\mu_j \geq 0, \quad j = 1, \dots, m \quad (3.16)$$

The vectors  $\boldsymbol{\mu}$  and  $\boldsymbol{\lambda}$  are called the Kuhn-Tucker multipliers. Constraints (3.13) and (3.14) are referred to as primal feasibility conditions, (3.15) is called the complementary

slackness condition and which requires the inequality constraint (3.16). Figure 3.4 shows an illustration of KKT conditions.

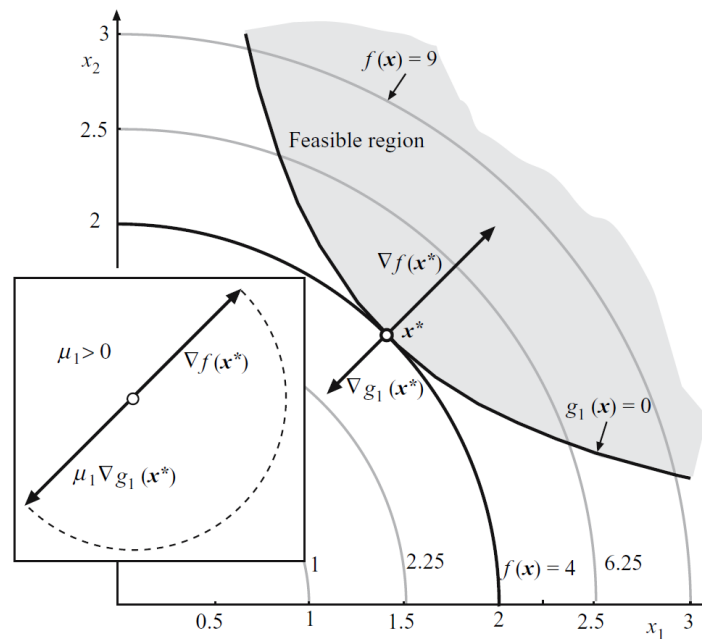

Figure 3.4 Illustration of the KKT conditions for the case of one inequality constraint in the bidimensional space. Figure from [74].

Using this theoretical background the nature of the unit commitment planning process divided between here-and-now and the wait-and-see decisions can be solved [75]. Furthermore the market [76], [77], [78], [79] and planning interactions [80], [81] can be described and solved using this theory.

We have dealt with the problem of the interaction between two levels of the market participation. We have formulated a bilevel model that simulates the interaction between the multi-energy entity and the rest of the system [82]. Figure 3.5 shows how the upper level problem segment deals with the optimization of the daily operational plan of the multi-energy entity system while the lower level of the proposed bi-level model represents the market model with the daily clearing process and formulation of the energy prices.



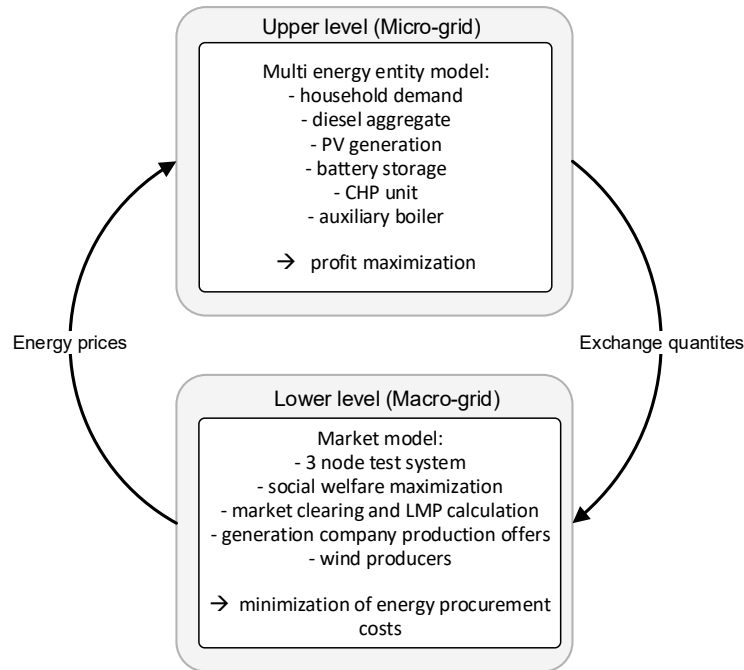

Figure 3.5 General structure of the bi-level problem [82]

Because of its bilevel structure and non-linearity introduced due to dependency between the levels, the problem cannot be solved using commercial solvers. Thus, it needs to be converted into a mathematical program with equilibrium constraints (MPEC). In other words, the set of lower-level problems needs to be converted to a set of constraints. Since each lower-level problem representing the market clearing of a market scenario is continuous and convex it can be represented through the constraints of the primal problem, the constraints of the dual problem and the strong duality condition of the duality theory. Hence, using the strong duality theorem, the equivalent of the lower-level problem consists of its primal constraints, its dual constraints and the strong duality equation. This allowed us to solve the set problem and obtain the results that show the interaction between the chosen levels.

### 3.3. Receding horizon scheduling

The methodology for decision-making in real time operation on local multi-energy system/microgrid level has many key factors that must be included [83]. In general multi-energy systems comprise of both dispatchable units needed to keep the equilibrium between demand and production and uncontrollable units such as RES whose production cannot be precisely estimated need to be accounted for. The main drive and challenge for the control algorithms is the stochastic element associated with both production and load that cannot be perfectly forecasted [84] and that have changes that cannot be always accounted for. There are several

methods found in the literature that tackle the problem of finding the best control algorithm. In [85] a search for a solution of optimal operation of a microgrid is done using a non-dominated sorting algorithm that includes forecast error. Different approach using MILP (Mixed Integer Linear Programming) for a mid-term virtual power plant dispatch optimization was investigated in [86] where uncertainty of the wind and solar power generation is settled using storage in order to provide flexible operation. Furthermore, complex and computationally demanding approaches such as multiagent modelling [87], evolutionary strategies [88] and particle swarm optimization [89] do not guarantee global optimality of the solution. Multi-objective optimization genetic algorithms are the most commonly used technique attempting to capture both, for example, economic benefits and emission reductions [90], but the final result is not guaranteed to be the global optimum. On the other hand bi-level optimization model [94] deals with the uncertainties of the microgrid operation but the elements are not optimally sized and different MILP approaches have been developed [91], [92] [93].

In that direction, control algorithm that has been applied to different engineering processes for a long time [95] is the model predictive control. Just in the recent years was the value of such control recognized and good alignment with problems of microgrid control achieved in the environment where RES production share increases. More specifically, MILP approach coupled with such control has the potential to be efficient tool since it is based on future predictions as well as the present state of the system. This combination provides a good mechanism to deal with uncertainty of predictions implemented as either central controller [96] or as distributed controller [97]. The basic MPC concept can be summarized as an intention to control a multiple-input, multiple-output process while satisfying different constraints on the input and output variables [98]. If a reasonably accurate dynamic mathematical model of the process/system is available, model and current measurements can be used to predict future values of the outputs and plan for the length of the planning/look-ahead horizon. Then the appropriate changes in the input variables can be calculated based on both predictions and measurements. The changes in the individual input variables are coordinated after considering the input-output relationships represented by the process model. Figure 3.6 depicts a basic concept for the model predictive control.

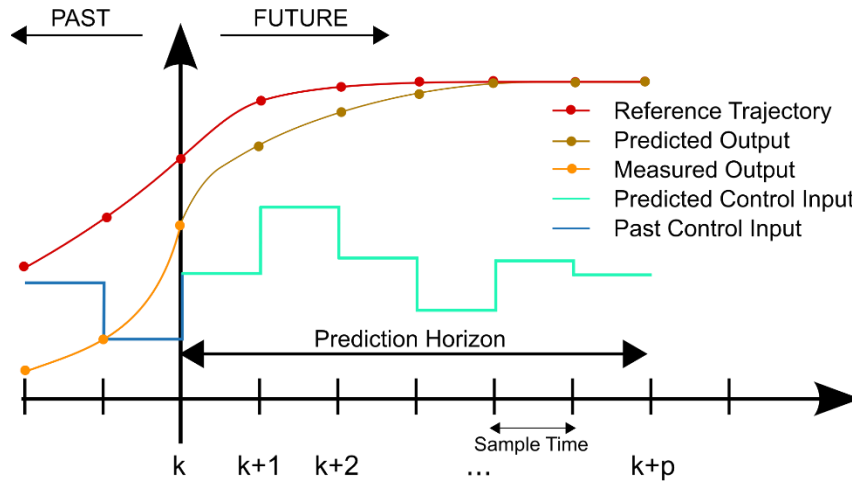

Figure 3.6 Basic concept of the model predictive control

It is important to notice that there are currently no integrated models including all the important elements (electric vehicles, EHP, battery and heat storage,  $\mu$ CHP etc.) and providing a comprehensive study of operational costs, energy usage, energy curtailment, losses, equipment degradation information, environmental study, uncertainty impact and optimal sizing problem. As was stated in the previous sections

As was mentioned, to clearly define different aspects of MEM flexibility in a daily operation, we developed a corrective scheduling algorithm with receding horizon based on model predictive control (MPC) scheme. The core of the central controller is the representative mathematical model of the system that is being controlled (in this case multi-energy system) which gives the desired operation as a result of the optimization process. The system responds through the receding horizon corrective algorithm to different external signals (e.g. energy and balancing prices) and is susceptible to different sources of uncertainty (e.g. wind and solar energy production, forecast errors, demand fluctuations, etc.) and therefore adjusts its outputs over the planning horizon. Objective function of our MILP algorithm is a cost minimization with a 24-hour horizon, describing day-ahead market participation of the multi-energy microgrid. To follow the main principles of the corrective scheduling the objective function, modelled by (3.17), consists of 3 segments which are further broken down into 3 segments ((3.18), (3.19) and (3.20)). It serves as an example how the principles of the model predictive control can be applied to a multi-energy problem [72].

$$COST = \sum_{t=1}^{24\cdot\tau+1-S} \{[\text{predicted (PRE)}] + [\text{mismatch (MIS)}]\} + \sum_{t=24\cdot\tau+1-S}^{24\cdot\tau} [\text{"updated" predicted costs (UPD)}] \quad (3.17)$$

$$PRE = \sum_{t=1}^{24\cdot\tau+1-S} \left[ (F_t^{ng} \cdot c^{ng} + F_t^{CCHP} \cdot c^f + F_t^D \cdot c^d) + (E_t^{imp0} \cdot c_t^{mcp} - E_t^{exp0} \cdot c_t^{mcp}) + (P \cdot E_t^{w-cur} + P \cdot H_t^{waste}) + \right. \\ \left. (H_t^{binCCHP} \cdot c_{const}^{CCHP} + H_t^{suCCHP} \cdot c_{start}^{CCHP}) + (E_t^{binD} \cdot c_{const}^D + E_t^{suD} \cdot c_{start}^D) + (emiss_t \cdot c^{emiss}) \right] \quad (3.18)$$

$$MIS = \sum_{t=1}^{24\cdot\tau+1-S} \left[ (-)short_t^{imp} \cdot M^{sell} \cdot c_t^{mcp} + long_t^{imp} \cdot M^{buy} \cdot c_t^{mcp} + short_t^{exp} \cdot M^{buy} \cdot c_t^{mcp} - long_t^{exp} \cdot M^{sell} \cdot c_t^{mcp} \right] \quad (3.19)$$

$$UPD = \sum_{t=24\cdot\tau+1-S}^{24\cdot\tau} \left[ F_t^{ng} \cdot c^{ng} + F_t^{CCHP} \cdot c^f + F_t^D \cdot c^d + E_t^{imp} \cdot c_t^{imp} - E_t^{exp} \cdot c_t^{exp} + P \cdot E_t^{w-cur} + P \cdot H_t^{waste} \right. \\ \left. + H_t^{binCCHP} \cdot c_{const}^{CCHP} + H_t^{suCCHP} \cdot c_{start}^{CCHP} + E_t^{binD} \cdot c_{const}^D + E_t^{suD} \cdot c_{start}^D + emiss_t \cdot c^{em} \right] \quad (3.20)$$

Equation (3.18) represents initial operational cost based on day-ahead prices. It gives total operational cost and schedule 12 hours ahead of the delivery (through simple deterministic optimization of available resources). The resulting values are used as references (day-ahead plan). Equation (3.19) represents the mismatch cost that stems from the difference between initial references and realized values. At the initial, scheduling decisions were based on the available information. Since these are subject to uncertainties and variabilities (such as wind and PV production) during real-time operation deviations from the original schedule occur. Equation (3.20) represents the updated plan for the remaining of the planning horizon considering current operational points of units, updated forecasts and initial reference plan. Following this mathematical formulation, we managed to achieve good behavior of the modelled system and managed to extract some important conclusions regarding the short-term operation indicators.

## 4. MAIN SCIENTIFIC CONTRIBUTION OF THE THESIS

The emphasis of the research described in this thesis was on developing a simulation framework that would allow for integrated modelling and evaluation of multi-energy systems. The research was conducted in 3 steps. First step included the development of the core mathematical linear mixed integer programming model that was used for finding the optimal operation of multi-energy systems. Second step included development of control framework that augments the core optimization set and that enables efficient control when multi-energy entity is participating in the stochastic environment of intra-day electricity market. Third step concluded the work with the observation how the multi-energy entity influences the larger scale electrical system operation from a single point of common coupling through analysis of market interdependency between upstream power system and multi-energy system.

For this purpose, corrective scheduling receding horizon MILP optimization framework was developed. The analyses focus can be presented through following sequences:

- a) Definition of the value of different flexible components such as electric heat pumps,  $\mu$ CHP, flexible loads, energy storage (both thermal and battery) on MEM ability to operate in the off-grid mode. Simulation of the off-grid operation over one-year period including emissions costs determining the optimal parameters with respect to the amount of unused energy or curtailed wind energy on microgrid level that serve as flexibility indicators. Search for optimal sizes of installed wind aggregates and PV units for given MEM configuration that are afterwards used to study how much flexibility can be gained by altering different elements capacities (e.g. heat storage or  $\mu$ CHP shares) through the detailed sensitivity analysis.
- b) Study of different compositions of MEM, in particular, the benefits of decentralized MEM units compared to a single central energy unit. All analyzed options must provide electricity, heat and cooling to the final consumer, without diminishing their comfort, through different trigeneration production unit technologies with their different belonging efficiencies.
- c) Investigating the modelling aspects and approximations impact, since common modelling approximations can be negligible in annual simulations (performed for planning purposes) but result in rather different short-term operation states (analyses for day ahead corrective scheduling). These approximations have critical importance in

assessing operational flexibility as they might lead to incorrect results and conclusions and therefore their effect is important to be evaluated;

- d) Evaluation of all above aspects through several defined flexibility indicators, wasted heat and curtailed wind, considering operational techno-economic constraints of different MEM components (battery storage, heat storage,  $\mu$ CHP). Evaluation is done in off-grid (islanded) mode and in on-grid (parallel) mode where interaction with the distribution system through the point of common coupling (PCC) is governed by receding horizon scheduling control algorithm whose addition improves the system's ability to react to prediction errors. It minimizes day ahead scheduling error of the MEM as well as the operational cost based on penalizing export/import balancing energy cost, emissions cost and total fuel cost.

Finally, the achieved scientific contributions of the research described in this doctoral thesis are briefly summarized here:

### **1) A new long-term optimization model of multi-energy systems**

The optimization and design process of the power systems is very important for efficient operation, investment reduction, increased flexibility and lower emissions. Optimally selecting what elements and in what installed capacities should different system be made of regarding the design requirements gains many long-long term benefits over the project or system lifetime.

We have developed a novel long-term optimization model for the multi-energy systems that includes deterministic long term simulation with the purpose of selecting optimal configuration and providing the sensitivity analysis insights [Pub 2], [Pub 3], [Pub 7].

### **2) A new receding horizon corrective scheduling algorithm for short-term optimal operation of multi-energy systems**

Control of power systems on all scales is complicated task, becoming even more complex with the advent of larger shares of renewable energy production. Dealing with the uncertain predictions and stochastic element inherent to the wind and solar production creates the challenge for efficient control.

We have introduced a new control concept called receding horizon corrective scheduling algorithm (RH-CSA) that allows for a significant mitigation of the variability of

RES production [Pub 1], [Pub 2], [Pub 6]. The algorithm applied to the multi-energy system, the simulations have shown, enables solving the problem of wide scale integration of renewables on the local level. Meaning that smaller entities, such as multi-energy microgrids, utilizing efficient control, can deal with the uncertainties of production and offer the rest of the systems desirable operation that can be accounted for [Pub 1], [Pub 2], [Pub 6].

### **3) A new model for defining the value of flexibility of multi-energy systems in the low-carbon power system operation**

Flexibility has become a key characteristic of modern power systems. The demand for power systems to have the ability to respond to unpredicted changes has been on an increase. Having the right information how much flexibility is available and how much can potentially be unlocked utilizing the available resources is therefore very important.

Through the developed optimization framework that incorporates both the deterministic and stochastic simulation environments and that incorporates both long-term and short-term aspects of operation we have defined and evaluated the flexibility of multi-energy systems with highlight on reducing the costs and emissions and increasing the operational efficiency. Furthermore, we have shown how different assumption impact the available flexibility and have shown the value and advantages of having the ability to operate all the energy vectors in a coupled manner [Pub 2], [Pub 4], [Pub 5].

## 5. LIST OF PUBLICATIONS

The main publications, both conference and journal ones, which are related to the thesis are listed here in the following list.

### JOURNAL PUBLICATIONS:

- [Pub 1] Holjevac, Ninoslav; Capuder, Tomislav; Zhang, Ning; Kuzle, Igor; Kang, Chongqing. “Corrective receding horizon scheduling of flexible distributed multi-energy microgrids”, *Applied Energy*, vol. 207, 2017, pp. 176-194
- [Pub 2] Holjevac, Ninoslav; Capuder, Tomislav; Kuzle, Igor. “Adaptive Control for Evaluation of Flexibility Benefits in Microgrid Systems”, *Energy*, vol. 92, Part 3, 2015, pp. 487-504
- [Pub 3] Holjevac, Ninoslav; Capuder, Tomislav; Kuzle, Igor. “Defining Key Parameters of Economic and Environmentally Efficient Residential Microgrid Operation”, *Energy Procedia*, vol. 105, 2017, pp. 999-1008

### CONFERENCE PUBLICATIONS:

- [Pub 4] Holjevac, Ninoslav, Capuder, Tomislav; Kuzle, Igor; Zhang, Ning; Kang, Chongqing, “Modelling Aspects of Flexible Multi-Energy Microgrids”, *2018 Power Systems Computation Conference (PSCC 2018)*, Dublin, Ireland, 2018, pp. 1-7
- [Pub 5] Holjevac, Ninoslav, Capuder, Tomislav; Kuzle, Igor. “Model for Defining the Potential and Value of Multi-Energy Microgrid Services to the Low Carbon Power System Operation”, *11th Mediterranean Conference on Power Generation, Transmission, Distribution and Energy Conversion (MEDPOWER 2018)*, Dubrovnik, Croatia, 2018, pp. 1-6
- [Pub 6] Holjevac, Ninoslav, Capuder, Tomislav; Kuzle, Igor. “Model for Defining the Potential and Value of Multi-Energy Microgrid Services to the Low Carbon Power System Operation”, *11th Mediterranean Conference on Power Generation, Transmission, Distribution and Energy Conversion (MEDPOWER 2018)*, Dubrovnik, Croatia, 2018, pp. 1-6



**EARLY ACCESS JOURNAL PUBLICATIONS**

- [Pub 7]**      Wujing, Huang, Ning Zhang, Chongqing, Kang, Capuder, Tomislav, Holjevac, Ninoslav, Kuzle, Igor. “Beijing Subsidiary Administrative Center Multi- Energy Systems: An Optimal Configuration Planning”, *Electric Power System Research*, 2019, vol. 179, 2020, early access

## 6. AUTHOR'S CONTRIBUTIONS TO THE PUBLICATIONS

The results presented in this thesis are based on the research carried out during the period from year 2014 to 2019 at the University of Zagreb, Faculty of Electrical Engineering and Computing, Department of Energy and Power Systems (Unska 3, 10000 Zagreb, Croatia) under the guidance of the supervisor prof. Igor Kuzle, PhD and in collaboration with prof. Tomislav Capuder, PhD.

Additionally, the work was also done during the external stay on the Tsinghua University (30 Shuangqing Rd, Beijing, China) [99] during the winter semester of the academic year 2016/2017 in collaboration with prof. Chongqing Kang, PhD and prof. Ning Zhang, PhD.

The research done is in the field and related to the following research projects:

- IRES-8 – “Instigation of Research and Innovation Partnership on Renewable Energy, Energy Efficiency and Sustainable Energy Solutions for Cities” co-funded by European Commission through the program of "EU-China research and innovation partnership" [100].
- FENISG – “Flexible Energy Nodes in Low Carbon Smart Grid” funded by Croatian Science Foundation under project grant No. IP-2013-11-7766 [101].
- FUTURE - “Flexible Urban Systems in Multi-Energy Environment” a bilateral project supported by Croatian Ministry of Science and Education and Tsinghua University [102].

The thesis includes seven publications written in collaboration with coauthors of the published papers. The author's contribution to published papers consists of the text writing, software and optimization tools implementation, conducting the required experiments and simulations, results analysis and presentation, discussion and revision of the work.

- **[Publication 1]** In the journal paper “**Corrective receding horizon scheduling of flexible distributed multi-energy microgrids**” [27] the author has developed an optimization model and simulation framework to define optimal configuration between centralized and distributed multi-energy system configuration and consider the flexibility benefits of additional energy vectors in coupled operation. Furthermore, the model was enhanced with several modes to assess the significance of error different commonly used

approximations can bring to the operational costs. This led to an important conclusion that long-term costs are independent of the model approximations while significant error occurs in the short-term daily operation analysis. The optimization model was developed in FICO Xpress and the daily simulation tools was implemented in MATLAB. The author has processed the results, discussed them with coauthors and took part in writing of the paper.

- **[Publication 2]** In the journal paper “**Adaptive control for evaluation of flexibility benefits in microgrid systems**” [34] the author has together with the coauthors conceived the optimization framework that included the integrated MILP formulation for optimal operation of developed microgrid model implemented in FICO Xpress. The optimal configuration of elements was discussed and the foundation for the implementation of model predictive control to reduce the impact of uncertainties was set. The author demonstrated benefits of the proposed approach in comparison to the commonly used approaches. The author performed simulation analysis and wrote and revised the manuscript.
- **[Publication 3]** In the journal paper titled “**Defining Key Parameters of Economic and Environmentally Efficient Residential Microgrid Operation**” [36] author derived the new algorithm segments to provide insight of the flexibility drivers with the special focus given to the energy storage and cogeneration units. The code was expanded in FICO Xpress and the data processing and simulation was done in MATLAB. The author wrote the paper and discussed and altered the simulation in accordance to the coauthor’s inputs.
- **[Publication 4]** In the conference paper titled “**Modelling Aspects of Flexible Multi-Energy Microgrids**“ [72] the author took part in defining new visualization approach of the results and in implementation of the corrective receding horizon control framework and data processing in MATLAB. The author wrote the manuscript.
- **[Publication 5]** In the conference paper titled “**Model for Defining the Potential and Value of Multi-Energy Microgrid Services to the Low Carbon Power System Operation**” [82] the author developed a bi-level optimization model to simulate the parallel operation of a multi-energy system

and transmission system. The author, in collaboration with the coauthors, developed a model, analyzed the results and wrote the paper.

- **[Publication 6]** In the conference paper titled “**Model Predictive Control for Scheduling of Flexible Microgrid Systems**” [35] the author developed a deterministic optimization model of the microgrid system and used the model to perform the optimal configuration simulation for different elements and a series of sensitivity analyses. The author, together with the coauthors, interpreted the results and wrote the paper.
- **[Publication 7]** In the paper titled “**Beijing Subsidiary Administrative Center Multi- Energy Systems: An Optimal Configuration Planning**” [103] the case study of the multi-energy system Beijing subsidiary administrative center was used to show the operation of the two-stage optimization model based on the energy hub developed in MATLAB. The author participated in the results discussion and writing of the paper.

All the papers in their final versions are included in the “Publications” section of the Thesis.

## 7. CONCLUSION AND FUTURE DIRECTIONS

The main achieved objective of conducted research is formulation of a novel mathematical optimization model and central control framework capable of analyzing and improving operational capabilities of different compositions of multi-energy systems and measuring the effect of different modelling aspects and approximations. This was done under market driven environment through defined flexibility indicators. Furthermore, the framework enables evaluation of potential system benefits of proposed coordinated and coupled operation of all multi-energy microgrid elements observed from one connection point – point of common coupling.

The novel research results are described through three achieved contributions. The first contribution of this thesis is the new mixed integer linear optimization model for the long-term operation of the multi-energy microgrid. The second contribution is the simulation framework that connects the optimization algorithm with the novel receding horizon corrective scheduling algorithm for the short-term operation of the multi-energy microgrid under the stochastic environment conditions. The third contributions is the model for the definition of the value of flexibility of multi-energy systems in the low-carbon power system. All three contribution create a unique optimization framework aimed at providing new insights and answers for the multi-energy systems operation. The main focus is the flexibility aspect that can be unlocked through the novel usage of already present resources and multi-energy microgrid components.

To obtain even more accurate results the more precise but non-linear model for the multi-energy system units could be incorporated as well as the network physical constraints. This could provide unsurpassed level of detail but the computational efficiency and the added value of these extra levels of details need to be investigated. Additionally, the implementation of proposed framework on a laboratory scale microgrid would manifold increase the value and support the simulation conclusions.

**BIBLIOGRAPHY**

- [1] O. Ogunrinde, E. Shittu, and K. K. Dhanda, "Investing in renewable energy: Reconciling regional policy with renewable energy growth," *IEEE Engineering Management Review*, vol. 46, no. 4, pp. 103–111, 2018.
- [2] T. W. V. Masson-Delmotte, P. Zhai, H. O. Portner, D. Roberts, J. Skea, P. R. Shukla, A. Pirani, W. Moufouma-Okia, C. P'ean, R. Pidcock, S. Connors, J. B. R. Matthews, Y. Chen, X. Zhou, M. I. Gomis, E. Lonnoy, T. Maycock, M. Tignor, "IPCC, 2018: Summary for Policymakers. In: Global warming of 1.5°C. An IPCC Special Report on the impacts of global warming of 1.5°C above pre-industrial levels and related global greenhouse gas emission pathways, in the context of strengthening the global," World Meteorological Organization, Geneva, Tech. Rep., 2018.
- [3] L. Baringo and A. J. Conejo, "Wind power investment within a market environment", *Applied Energy*, vol. 88, no. 9, pp. 3239–3247, 2011.
- [4] M. Manfren, P. Caputo and G. Costa, "Paradigm shift in urban energy systems through distributed generation: methods and models". *Applied Energy*; vol. 88(4), pp. 1032–48, 2011.
- [5] P. Mancarella, Multi-energy systems: an overview of models and evaluation concepts", *Energy*, vol. 65, 2014, pp. 1-17
- [6] P. Siano, "Assessing the Impact of Incentive Regulation for Innovation on RES Integration", *IEEE Transactions on Power Systems*, vol. 29, pp. 2499–2508, 2014.
- [7] D.F. Dominković, I. Bačeković, B. Čosić, G. Krajačić, T. Pukšec, N. Duić and N. Markovska, "Zero carbon energy system of South East Europe in 2050", *Applied Energy*, vol. 184, pp. 1517-1528, 2016.
- [8] EU Commission directives: „Clean energy for all Europeans”, 2019.
- [9] European Parliament, "Directive (EU) 2018/2001 on the promotion of the use of energy from renewable sources", EU, 2018.
- [10] P. Kundur, "Power System Stability and Control", McGraw-hill, USA, 1994.

- 
- [11] G.Chicco and P.Mancarella, "Distributed multi-generation: A comprehensive view", *Renewable and Sustainable Energy Reviews*, vol. 13, No. 3, pp. 535-551, 2009.
- [12] C. Weber, N. Shah, "Optimization based design of a district energy system for an eco-town in the United Kingdom", *Energy*, vol. 36, pp. 1292-1308, 2011.
- [13] Hatziargyriou, N., Asano, H., Iravani, R. and Marnay, C., "Microgrids", *IEEE Power & Energy Magazine*, 2007.
- [14] P. Mancarella, G. Chicco, "Real-time demand response from energy shifting in distributed multi-generation", *IEEE Transactions on Smart Grid*, vol. 4(4), pp. 1928-1938, 2013.
- [15] L. Kriechbaum, G. Scheiber and T. Kienberger, "Grid-based multi-energy systems—modelling, assessment, open source modelling frameworks and challenges", *Energy, Sustainability and Society*, vol 8, pp. 1-35, 2018.
- [16] P. Mancarella, G. Chicco, "Distributed multi-generation: energy models and analyses", New York: Nova Publisher; 2009.
- [17] I. Pavić, N. Holjevac, M. Zidar, I. Kuzle and A. Nešković, "Transportation and power system interdependency for urban fast charging and battery swapping stations in Croatia," *2017 40th International Convention on Information and Communication Technology, Electronics and Microelectronics (MIPRO)*, Opatija, pp. 1465-1470, 2017.
- [18] T. Martinsen, N. Holjevac, B. Bremdal, I. Kuzle, J. Guerrero, T. Dragicevic, I. Pavić, Q. Shafiee, "Improved grid operation through power smoothing control strategies utilizing dedicated energy storage at an electric vehicle charging station", *CIREN 2016 Conference*, Helsinki 14-15 June, 2016.
- [19] R. Loisel, G. Pasaoglu and C. Thiel, "Large-scale deployment of electric vehicles in Germany by 2030: An analysis of grid-to-vehicle and vehicle-to-grid concepts", *Energy Policy*, vol. 65, pp. 432-443, 2014.
- [20] I. Pavic, T. Capuder, N. Holjevac and I. Kuzle, "Role and impact of coordinated EV charging on flexibility in low carbon power systems," *2014 IEEE International Electric Vehicle Conference (IEVC)*, Florence, Italy, pp. 1-8, 2014.

- [21] G. Strbac, C.K. Gan, M. Aunedi, V. Stanojevic, P. Djapic, J. Dejvices, et al. "Benefits of advanced smart metering for demand response based control of distribution networks", Report for the Energy Networks Association (ENA); UK, 2010.
- [22] P. Papadaskalopoulos, G. Strbac, P. Mancarella, M. Aunedi, V. Stanojevic, "Decentralized participation of flexible demand in electricity markets. Part II: application with electric vehicles and heat pump systems", *IEEE Transactions on Power Systems*, vol. 28(4), pp. 3667-3774, 2013.
- [23] M. Geidl, G. Andersson, "Optimal power flow of multiple energy carriers", *IEEE Transaction on Power Systems*, vol. 22(1), pp 145-155, 2007.
- [24] M. Geidl, G. Koeppel, P. Favre-Perrod, B. Klöckl, G. Andersson, K. Fröhlich, "Energy Hubs for the Future", *IEEE Power Energy Magazine*, vol 5(1), pp. 25-30, 2007.
- [25] Horlock JH. "Cogeneration-combined heat and power (CHP)", FL: Krieger, 1997.
- [26] D.W. Wu, R. Wang. "Combined cooling, heating and power: a review", *Prog Energy Combust Sc*, vol. 32, pp. 459-495, 2006.
- [27] N. Holjevac, T: Capuder, N. Zhang, Kuzle, Igor; C. Kang, "Corrective receding horizon scheduling of flexible distributed multi-energy microgrids", *Applied Energy*, vol. 207, pp. 176-194, 2017.
- [28] W. Kusch, T Schmidla, I. Stadler, "Consequences for district heating and natural gas grids when aiming towards 100% electricity supply with renewable", *Energy*, vol. 48, pp. 153-159, 2012.
- [29] C. Weber, D. Favrat, "Conventional and advanced CO2 based district energy systems", *Energy*, vol. 35, pp. 5070-5081, 2012.
- [30] S. Bracco, F. Delfino, F. Pampararo, M. Robba, M Rossi, "The University of Genoa smart polygeneration microgrid test-bed facility: the overall system, the technologies and the research challenges", *Renewable and Sustainable Energy Reviews*, vol. 18, pp.442-459, 2013.
- [31] R. P. Menon, M. Paolone, F. Maréchal, "Study of optimal design of polygeneration, systems in optimal control strategies", *Energy*, vol. 55, pp.134-141, 2013.



- [32] A. Piacentino, C. Barbaro, F. Cardona, R. Gallea, E. Cardona, "A comprehensive tool for efficient design and operation of polygeneration-based energy mgrids serving a cluster of buildings. Part I: Description of the method", *Appl Energy*, vol. 111, pp. 1204-1221, 2013.
- [33] A. Piacentino, C. Barbaro, "A comprehensive tool for efficient design and operation of polygeneration-based energy mgrids serving a cluster of buildings. Part II: Analysis of the applicative potential", *Appl Energy*, vol. 111, pp.1222-1238, 2013
- [34] N. Holjevac, T. Capuder, I. Kuzle, "Adaptive Control for Evaluation of Flexibility Benefits in Microgrid Systems", *Energy*, vol. 92, Part 3, pp. 487-504, 2015.
- [35] I. Kuzle, N. Holjevac; T. Capuder, "Model Predictive Control for Scheduling of Flexible Microgrid Systems", *9th Conference on Sustainable Development of Energy, Water and Environment Systems (SDEWES 2014)*, Venice, Italy, pp. 1-20, 2014.
- [36] N. Holjevac, T. Capuder, I. Kuzle, "Defining Key Parameters of Economic and Environmentally Efficient Residential Microgrid Operation", *Energy Procedia*, vol. 105, pp. 999-1008, 2017.
- [37] E. Lannoye, D. Flynn and M. O'Malley, "Evaluation of Power System Flexibility," *IEEE Transactions on Power Systems*, vol. 27, no. 2, pp. 922-931, 2012.
- [38] I. Pavić. T. Capuder and I. Kuzle, "Low Carbon Technologies as Providers of Operational Flexibility in Future Power Systems", *Applied Energy*, vol. 168, pp. 724-738, 2016.
- [39] E. Olivares, A. Mehrizi-Sani, A.H. Etemadi, C.A. Canizares, R. Iravani, M. Kazerani, A. H. Hajimiragha, O. Gomis-Bellmunt, M. Saadedifard, R. Palma-Behnke, G.A. Jimenez-Estevez and N. D. Hatziargyriou, "Trends in Microgrid Control", *IEEE Transactions on Smart Grid*, vol. 5, pp. 1905-1919, 2014.
- [40] M. Hakimi and S. M. Moghaddas-Tafreshi, "Optimal Planning of a Smart Microgrid Including Demand Response and Intermittent Renewable Energy Resources", *IEEE Transactions on Smart Grid*, vol. 5, pp. 2889-2900, 2014.
- [41] E. Lannoye, D. Flynn and M. O'Malley, "Transmission, Variable Generation, and Power System Flexibility," *IEEE Transactions on Power Systems*, vol. 30, no. 1, pp. 57-66, 2015.

- [42] E. Lannoye, D. Flynn and M. O'Malley, "Evaluation of Power System Flexibility", *IEEE Transactions on Power Systems*, vol. 27, pp. 922-931, 2012.
- [43] Group of authors: „Flexibility in 21st Century Power Systems,“ National Renewable Energy Laboratory (NREL), USA, 2014.
- [44] W. Hung, "Transmission system requirements and ancillary services provision," in *Proc. IET Seminar on Power Gen. Control*, pp. 37–53, 2007.
- [45] N. Troy, E. Denny, M. O'Malley, "Base-load cycling on a system with significant wind penetration", *IEEE Transactions on Power Systems*, vol. 25, pp. 1088–1097, 2010.
- [46] T. Capuder and P. Mancarella, "Techno-economic and Environmental Modelling and Optimization of Flexible Distributed Multi-generation Options", *Energy*, vol. 71, pp. 516-533, 2014.
- [47] H. Pandžić, I. Kuzle and T. Capuder, "Virtual power plant mid-term dispatch optimization", *Applied Energy*, vol. 101, pp. 134-141, 2011.
- [48] Y. Dvorkin, R. Fernandez-Blanco, D. S. Kirschen, H. Pandžić, J.-P. Watson, and C. A. Silva-Monroy, "Ensuring Profitability of Energy Storage", *IEEE Transactions on Power Systems*, vol. 32, pp. 611–623, 2016.
- [49] P. Mancarella, "MES (multi-energy systems): an overview of concepts and evaluation models", *Energy*, vol. 65, pp. 1–17, 2014.
- [50] N. Good, E. Karangelos, A. Navarro-Espinosa, and P. Mancarella, "Optimization under Uncertainty of Thermal Storage-Based Flexible Demand Response with Quantification of Residential Users' Discomfort", *IEEE Transactions on Smart Grid*, vol. 6, pp. 2333–2342, 2015.
- [51] A. Majzoobi and A. Khodaei, "Application of Microgrids in Providing Ancillary Services to the Utility Grid", *Energy*, vol. 123, pp. 555-563, 2017.
- [52] A. Saint-Pierre and P. Mancarella, "Active Distribution System Management: A Dual-Horizon Scheduling Framework for DSO/TSO Interface under Uncertainty," *IEEE Transactions on Smart Grid*, pp. 1–12, 2016.

- [53] T. Capuder and P. Mancarella, "Assessing the Benefits of Coordinated Operation of Aggregated Distributed Multi-Energy Generation", *Power System Computation Conference (PSCC 2016)*, Genoa, Italy pp. 1–7, 2016.
- [54] H Cui, F. Li, Q. Hu, L. Bai and X. Fang, "Day-ahead Coordinated Operation of Utility-scale Electricity and Natural Gas Networks Considering Demand Response Based Virtual Power Plants", *Applied Energy*, vol. 176, pp. 183-195, 2016.
- [55] A. Ghahgharaee Zamani, A. Zakariazadeh and S. Jadid, "Day-ahead resource scheduling of a renewable energy based virtual power plant", *Applied Energy*, vol. 169, pp. 324-340, 2016.
- [56] M. Rahimiyan and L. Baringo, "Strategic Bidding for a Virtual Power Plant in the Day-Ahead and Real-Time Markets: A Price-Taker Robust Optimization Approach", *IEEE Transactions on Power Systems*, vol. 31, pp. 2676–2687, 2016.
- [57] N. Zhang, C. Kang, Q. Xia, Y. Huang, "A Convex Model of Risk-Based Unit Commitment for Day-Ahead Market Clearing Considering Wind Power Uncertainty", *IEEE Transactions on Power Systems*, vol. 30, pp. 1582-1592, 2014.
- [58] G. Chicco and P. Mancarella, "Matrix Modelling of Small-scale Trigeneration Systems and Application to Operational Optimization", *Energy*, vol. 34, pp. 261–273, 2009.
- [59] T. Capuder and P. Mancarella, "Techno-economic and Environmental Modelling and Optimization of Flexible Distributed Multi-Generation Options", *Energy*, vol. 71, pp. 516-533, 2014.
- [60] H. Wang and P. Mancarella, Towards Sustainable Urban Energy Systems : "High Resolution Modelling of Electricity and Heat Demand Profiles", *IEEE Powercon Conference 2016*, Wollongong, Australia, pp. 1–6, 2016.
- [61] P. Mancarella and G. Chicco, "Demand Response from Energy Shifting in Distributed Multi-Generation", *IEEE Transactions on Smart Grid*, vol. 4, pp. 1928–1938, 2013.
- [62] N. Holjevac, T. Capuder, I. Kuzle, "Defining Key Parameters of Economic and Environmentally Efficient Residential Microgrid Operation", *Energy Procedia*, vol. 105, pp. 999-1008, 2017.

- [63] Elexon Imbalance Pricing Guidance – A guide to electricity imbalance pricing, UK, version 13.0, 2019.
- [64] T. Dragicevic, X. Lu, J. C. Vasquez, J. M. Guerrero, *IEEE Transactions on Power Electronics* 31 (2016) 4876–4891.
- [65] Pandžić, Hrvoje; Dragičević, Tomislav, Chapter 19: Control of smart grid architecture, *Control of Power Electronic Converters and Systems Volume 2*, Blaabjerg, Frede, London, 2018. pp. 208-232
- [66] Y. Huang et al., "Electrical Power Unit Commitment", *Springer Briefs in Energy*, 2017.
- [67] Q. Wang, J. Wang, Y. Guan, "Price-based unit commitment with wind power utilization constraints", *IEEE Transactions on Power Systems*, vol. 28(3), pp. 2718–2726, 2013.
- [68] B.F. Hobbs, M.H. Rothkopf, R.P. O’Neil, H. Chao, "The next generation of electric power unit commitment models", *Springer International Series in Operations Research & Management Science*, 2001.
- [69] Y. Huang, Q.P. Zheng, J. Wang, "Two-stage stochastic unit commitment model including non-generation resources with conditional value-at-risk constraints", *Electric Power Syst Research*, vol. 116, pp. 427–438, 2014.
- [70] Y. Fu, M. Shahidehpour, Z. Li, "Security-constrained unit commitment with AC constraints", *IEEE Transactions on Power System*, vol. 20(2), pp.1001–1013, 2005.
- [71] Q.P. Zheng, J. Wang, P.M. Pardalos, Y. Guan, "A decomposition approach to the two-stage stochastic unit commitment problem", *Annals of Operations Research*, vol. 210, pp. 387-410, 2013.
- [72] N. Holjevac, T. Capuder; I. Kuzle, N. Zhang, C. Kang, "Modelling Aspects of Flexible Multi-Energy Microgrids", *2018 Power Systems Computation Conference (PSCC 2018)*, Dublin, Ireland, pp. 1-7, 2018.
- [73] L. Qi, H. Jiang, "Semismooth Karush-Kuhn-Tucker Equations and Convergence Analysis of Newton and Quasi-Newton Methods for Solving these Equations", *Mathematics of Operations Research*, Vol. 22(2), 1997.

- [74] A. J. Conejo, E. Castillo, R. Mínguez, R. García-Bertrand, "Decomposition Techniques in Mathematical Programming", *Engineering and Science Applications Springer*, 2006.
- [75] J. M. Morales, A. J. Conejo and J. Perez-Ruiz, "Economic Valuation of Reserves in Power Systems with High Penetration of Wind Power", *IEEE Transactions on Power Systems*, vol. 24, no. 2, pp. 900-910, 2009.
- [76] M. Yazdani-Damavandi, N.Neyestani, M.Shafie-khah, J.Contreras and J.P.S. Catalao, "Strategic Behavior of Multi-Energy Players in Electricity Markets as Aggregators of Demand Side Resources using a Bi-level Approach", *IEEE Transactions on Power Systems*, vol. 33, pp. 397-411, 2018.
- [77] M. Shafie-khah, E. Heydarian-Forushani, M. E. H. Golshan, M. P. Moghaddam, M. K. Sheikh-El-Eslami, and J. P. S. Catalao, "Strategic offering for a price-maker wind power producer in oligopoly markets considering demand response exchange," *IEEE Trans. Ind. Information*, vol. 11, no. 6, pp. 1542–1553, 2015.
- [78] M. Zugno, J. M. Morales, P. Pinson, and H. Madsen, "A bilevel model for electricity retailers participation in a demand response market environment," *Energy Econ.*, vol. 36, pp. 182–197, 2013.
- [79] H. Pandžić, I. Kuzle, „Energy Storage Operation in the Day-Ahead Electricity Market“, *IEEE 2015 12th International Conference on the European Energy Market (EEM)*, Lisbon, 2015.
- [80] L. P. Garces, A. J. Conejo, R. Garcia-Bertrand and R. Romero, "A Bilevel Approach to Transmission Expansion Planning Within a Market Environment," *IEEE Transactions on Power Systems*, vol. 24, no. 3, pp. 1513-1522, 2009.
- [81] S. de la Torre, A. J. Conejo, and J. Contreras, "Transmission expansion planning in electricity markets," *IEEE Trans. Power Syst.*, vol. 23, no. 1, pp. 238–248, 2008.
- [82] N. Holjevac, T. Capuder, I. Kuzle, "Model for Defining the Potential and Value of Multi-Energy Microgrid Services to the Low Carbon Power System Operation", *11th Mediterranean Conference on Power Generation, Transmission, Distribution and Energy Conversion (MEDPOWER 2018)*, Dubrovnik, Croatia, pp. 1-6, 2018.

- [83] Georgios M. Kopanos, M. C. Georgiadis, E. N. Pistikopoulos, "Energy production planning of a network of micro combined heat and power generators", *Applied Energy*, vol. 102, pp. 1522-1534, 2013.
- [84] N. Holjevac, C. Soares, I. Kuzle, "Short-term power system hourly load forecasting using artificial neural networks", *Journal of Energy*, vol. 66, pp. 241-254, 2017.
- [85] E. R. Sanseverino, M. L. Di Silvestre, M. G. Ippolito, A. De Paola, G. Lo Re, "An execution, monitoring and replanning approach for optimal energy management in microgrids", *Energy*, vol. 36, pp. 3429-3436, 2011.
- [86] H. Pandzic, J.M. Morales, A. Conejo and I.Kuzle, "Offering model for a virtual power plant based on stochastic programming", *Applied Energy*, vol. 105. pp. 282–292, 2013.
- [87] L. Wang, Z. Wang., R. Yang, "Intelligent multiagent control system for energy and comfort management in smart and sustainable buildings." *IEEE Trans Smart Grid*, vol 3, pp. 605–17., 2012.
- [88] A. Basu, "Microgrids: Planning of fuel energy management by strategic deployment of CHP-based DERs - an evolutionary algorithm approach", *Electric Power and Energy Systems*, vol 44, pp.326–336., 2013.
- [89] S. M. Hakimi, S. M. Moghaddas-Tafreshi, "Optimal Planning of a Smart Microgrid Including Demand Response and Intermittent Renewable Energy Resources", *IEEE Trans. on Smart Grid*, vol. 5, pp. 2889-2900, 2015.
- [90] Q. Deng, X. Gao, H. Zhou, W. and Hu, "System modeling and optimization of microgrid using genetic algorithm," *2nd Int. Conf. Intelligent Control and Information Processing*, pp. 540–544, 2011.
- [91] A. Parisio, E. Rikos, G. Tzamalis, L. Glielmo, "Use of model predictive control for experimental microgrid optimization", *Applied Energy*, vol 115, pp. 37-46, 2014.
- [92] A. Molderink, V. Bakker, M: Bosman, J. Hurink, and G. Smit, "On the effects of MPC on a domestic energy efficiency optimization methodology," *IEEE EnergyCon 2010*, pp. 120–125, 2010.
- [93] M. Marietta, M. Grealls, J.M. Guerrero, "A Rolling Horizon rescheduling Strategy for Flexible Energy in a Microgrid", *2014 IEEE International Energy Conference (ENERGYCON)*, Cavtat, Croatia, pp. 1297-1303, 2014.

- [94] Z. Wang, B. Chen, J. Wang, M.M. Begovic, C. Chen, "Coordinated Energy Management of Networked Microgrids in Distribution Systems", *IEEE Transactions on Smart Grid*, vol. 6, pp. 45-53, 2014.f
- [95] C.R. Cutler, B.L. Ramaker, "Dynamic matrix control - a computer control algorithm", *Proceedings of the Joint Automatic Control Conference*, San Francisco, USA, 1979.
- [96] M. Marinelli, F. Sossan, G.T. Costanzo, H.W. Bindner, "Testing of a Predictive Control Strategy for Balancing Renewable Sources in a Microgrid", *IEEE Transactions on Sustainable Energy*, vol.5, pp. 1426-1433, 2014.
- [97] G. Larsen, N.D. van Foreest, J. M. A. Scherpen, "Distributed MPC Applied to a Network of Households With Micro-CHP and Heat Storage", *IEEE Trans. on Smart Grid*, vol. 5, pp 2016-2114, 2014.
- [98] D.E. Seborg, T.F. Edgar, D.A. Mellichamp, F.J. Doyle III, "Process Dynamics and Control", Wiley, third edition, USA, 2011.
- [99] Tsinghua University, <https://www.tsinghua.edu.cn/publish/thu2018en/index.html> accessed May 2019.
- [100] IRES 8 project - Instigation of Research and Innovation Partnership on Renewable Energy, Energy Efficiency and Sustainable Energy Solutions for Cities, <https://www.fer.unizg.hr/zvne/ires-8>, accessed June 2019.
- [101] FENISG project - Flexible Energy Nodes In Low Carbon Smart Grid, <http://www.fenisg.org/>, accessed June 2019.
- [102] FUTURE project - Flexible Urban Systems in Multi-Energy Environment, <https://www.fer.unizg.hr/zvne/projects/future>, accessed June 2019
- [103] W. Huang, N. Zhang, C. Kang, T. Capuder, N. Holjevac, I. Kuzle "Beijing Subsidiary Administrative Center Multi- Energy Systems: An Optimal Configuration Planning", *Electric Power System Research*, 2019, under review, submitted March 2019.

---

## PUBLICATIONS

- [Pub 1]** Holjevac, Ninoslav; Capuder, Tomislav; Zhang, Ning; Kuzle, Igor; Kang, Chongqing. “Corrective receding horizon scheduling of flexible distributed multi-energy microgrids”, *Applied Energy*, vol. 207, 2017, pp. 176-194
- [Pub 2]** Holjevac, Ninoslav; Capuder, Tomislav; Kuzle, Igor. “Adaptive Control for Evaluation of Flexibility Benefits in Microgrid Systems”, *Energy*, vol. 92, Part 3, 2015, pp. 487-504
- [Pub 3]** Holjevac, Ninoslav; Capuder, Tomislav; Kuzle, Igor. “Defining Key Parameters of Economic and Environmentally Efficient Residential Microgrid Operation”, *Energy Procedia*, vol. 105, 2017, pp. 999-1008
- [Pub 4]** Holjevac, Ninoslav, Capuder, Tomislav; Kuzle, Igor; Zhang, Ning; Kang, Chongqing, “Modelling Aspects of Flexible Multi-Energy Microgrids”, *2018 Power Systems Computation Conference (PSCC 2018)*, Dublin, Ireland, 2018, pp. 1-7
- [Pub 5]** Holjevac, Ninoslav, Capuder, Tomislav; Kuzle, Igor. “Model for Defining the Potential and Value of Multi-Energy Microgrid Services to the Low Carbon Power System Operation”, *11th Mediterranean Conference on Power Generation, Transmission, Distribution and Energy Conversion (MEDPOWER 2018)*, Dubrovnik, Croatia, 2018, pp. 1-6
- [Pub 6]** Holjevac, Ninoslav, Capuder, Tomislav; Kuzle, Igor. “Model for Defining the Potential and Value of Multi-Energy Microgrid Services to the Low Carbon Power System Operation”, *11th Mediterranean Conference on Power Generation, Transmission, Distribution and Energy Conversion (MEDPOWER 2018)*, Dubrovnik, Croatia, 2018, pp. 1-6
- [Pub 7]** Wujing, Huang, Ning Zhang, Chongqing, Kang, Capuder, Tomislav, Holjevac, Ninoslav, Igor Kuzle, “Beijing Subsidiary Administrative Center Multi- Energy Systems: An Optimal Configuration Planning”, *Electric Power System Research*, vol. 179, 2020, early access.



**Publication 1 – Corrective receding horizon scheduling of flexible distributed multi-energy microgrids**

Holjevac, Ninoslav; Capuder, Tomislav; Zhang, Ning; Kuzle, Igor; Kang, Chongqing. “Corrective receding horizon scheduling of flexible distributed multi-energy microgrids”, *Applied Energy*, vol. 207, 2017, pp. 176-194  
DOI: 10.1016/j.apenergy.2017.06.045

- 19 pages

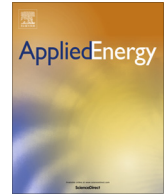

# Corrective receding horizon scheduling of flexible distributed multi-energy microgrids



Ninoslav Holjevac<sup>a,\*</sup>, Tomislav Capuder<sup>a</sup>, Ning Zhang<sup>b</sup>, Igor Kuzle<sup>a</sup>, Chongqing Kang<sup>b</sup>

<sup>a</sup>University of Zagreb Faculty of Electrical Engineering and Computing, Unska 3, 10000 Zagreb, Croatia

<sup>b</sup>Tsinghua University Department of Electrical Engineering, Haidian, Beijing, China

## HIGHLIGHTS

- Defining optimal configuration between centralized and distributed MEM configurations.
- Flexibility of MEM increases with consideration of additional energy vectors.
- Annual operational costs are independent of the model approximations (e.g. MEM unit efficiency modelling).
- Significant errors occur if approximations are used for MEM daily operation analyses.

## ARTICLE INFO

### Article history:

Received 30 January 2017

Received in revised form 3 June 2017

Accepted 12 June 2017

Available online 24 June 2017

### Keywords:

Multi-energy systems

Trigeneration

Flexibility

Uncertainty

Corrective scheduling

## ABSTRACT

The goal of the paper is to provide a comprehensive operational flexibility evaluation of different Multi-energy Microgrid (MEM) options. This is done by incorporating Mixed Integer Linear Programming (MILP) model for annual simulations and expanding it with Receding Horizon Model Predictive Control (RH-MPC) algorithm for short term daily operational analyses. The model optimizes flows of various energy vectors: heat, fossil fuels (natural gas), cooling and electricity, coordinating different microgrid elements with the goal of serving final consumer needs and actively participating in energy markets.

The second novelty of the work is in the approach to multi-energy operational flexibility assessment, capturing different technologies, MEM configurations and different modelling concepts. When MEM is connected to the upstream power system its flexibility manifests as capability to alleviate variability and uncertainty in local production of RES and demand. On the other hand, when operating isolated from the rest of the system, the main flexibility indicator is minimum waste of energy while ensuring the satisfaction of all demand needs (electrical and heating/cooling). Following on this, multiple MEM configurations have been analyzed, showing different levels of available flexibility and capability to follow scheduled day-ahead exchange with the rest of the system, but also different amounts of wasted/curtailed energy in off-grid mode. Additionally, detailed analyses are performed concerning algorithm approximations which are often introduced in MEM modelling, such as efficiency of generation units. While these approximations have smaller impact on annual operational flexibility assessment (the difference is around 2–5% in terms of total cost), the result clearly show their significant impact on daily operational flexibility estimates.

© 2017 The Authors. Published by Elsevier Ltd. This is an open access article under the CC BY-NC-ND license (<http://creativecommons.org/licenses/by-nc-nd/4.0/>).

## 1. Introduction

### 1.1. Introduction and motivation

Integration of renewable energy sources today is largely driven by incentives [1] and general goal of the European Union to

increase the share of zero emission generation [2]. However, passive integration of these sources close to the consumers might result in significant over investments driven by needed improvements on the distribution grid level [3,4]. In addition, the idea and design of all renewable energy system (RES) [5] and global energy policy [6] should be put hand in hand with the latest strategic goal announced in Europe; at least 50% of energy production should be in the hands of final consumers [7]. This also means that a significant share of operational flexibility, alleviating above mentioned issues, will come from the distribution level through integration of technologies capable of responding to different price

\* Corresponding author.

E-mail addresses: [ninoslav.holjevac@fer.hr](mailto:ninoslav.holjevac@fer.hr) (N. Holjevac), [tomislav.capuder@fer.hr](mailto:tomislav.capuder@fer.hr) (T. Capuder), [ningzhang@tsinghua.edu.cn](mailto:ningzhang@tsinghua.edu.cn) (N. Zhang), [igor.kuzle@fer.hr](mailto:igor.kuzle@fer.hr) (I. Kuzle), [cqkang@tsinghua.edu.cn](mailto:cqkang@tsinghua.edu.cn) (C. Kang).

signal. Evaluating the potential flexibility benefits of different technologies in the distribution level microgrids provides a valuable step towards a successful integration of renewable energy sources that will complement the low carbon technologies on a larger scale [8].

Microgrid is defined as a set of consumers, distributed generation and energy storages coordinated with the aim of achieving reliable supply for final consumers and exchanging predefined energy with the rest of distribution system through a point of common coupling (PCC) [9]. Scheduling microgrid operation is subject to imperfect forecasting of local RES or demand, however if these imbalances are compensated on the local level microgrids become flexible nodes capable of providing multiple flexibility services to the upstream system thus enabling larger integration of RES [10,11] (Fig. 1). Aggregating consumers of different energy vectors (electricity, gas, cooling) and distributed multi-generation sources on the same location with coupled centralized control is the main advantage of a multi-energy microgrid (MEM) concept.

Power system flexibility is becoming a key characteristic in answering the increasing share of variable generation. Technically, it can be defined as the ability to respond to changes in demand/generation equilibrium [12]. In economic sense, the flexibility can be defined as the capability of a single market subject to quickly adjust to most current market situation and follow the scheduled plan of exchange [13]. All power systems inherently have a certain flexibility level; with increase of unpredictable and variability RES these values are much higher. Lack of system flexibility can be manifested in frequency deviations which can lead to load shedding, deviations from contracted exchanges, wind curtailment, higher price volatility. The current system flexibility requirements are mostly based on deterministic calculation which increases the system costs and does not include variables that stretch through several time periods (intertemporal constraints) [14].

Traditionally all the imbalance between the production and consumption had to be compensated by centralized unit, however with the advent of new technologies ( $\mu$ CHP, electric vehicles, flexible demand, electric heat pumps etc.) new flexibility potential can be unlocked on the local, distribution level [15–17]. Concepts of a virtual power plants and microgrids (e.g. [18,19]) are well known, yet there is still a lack of integral approach to all energy vector assessment on a microgrid level, particularly in terms of interaction between the MEM and the rest of the system. This paper tackles the operational aspects also providing some valuable inputs for

planning, optimal sizing of microgrid elements [20] and business cases [21].

## 1.2. Current research

While integration of batteries and electric vehicles is widely researched for their capability to provide these flexibility services [22], it is equally important, if not more, to unlock the already existing flexibility in the distribution level energy systems. In this context multi-energy systems (MES) [23] and multi-energy microgrids (MEM) become increasingly relevant by coupling different units and shifting between energy vectors. Such systems have the capability of providing required services for the consumer without diminishing the comfort of final users and, on the other hand, to provide response to system requirements on different and multiple time frames [24,25]. Several research papers have shown significant benefits by means of adaptive dispatch and coordination of multi-energy systems in active distribution networks [26].

In order to utilize provision of price driven services from multi-energy entities such as MEM, or other flexible units at the distribution side, they need to be aggregated into a single entity since such market participation increases both market visibility, capability to compete in multiple market and, correspondingly, their benefits [27]. Aggregation in the concept of virtual power plants (VPP) is usually composed of conventional and renewable energy units (RES) [28,29]. The inability to forecast RES generation of the VPP defines participation of such units in the market, where flexible units such as storage are put in service of minimizing the level of variability and uncertainty announced ahead of realization of production [30,31]. Recent research focuses on robust or risk-based bidding strategies to overcome these issues [32], however such approach can lead to conservative solutions and non-optimal operating points. It is interesting to notice that already single MEM unit can be regarded as VPPs, since they are usually composed of several units coupled together [33]. Cooperation of these units results in both economic savings and environment impact reduction compared to separate production [34]. When grouping different multi-energy units the value of multiple energy vector shifting becomes even more highlighted [35].

On a microgrid level the local heat and cooling demands are more or less predictable and do not contribute significantly to uncertainty and variability; unlike local RES production. In addition, heat and cooling have a significant amount of inertia

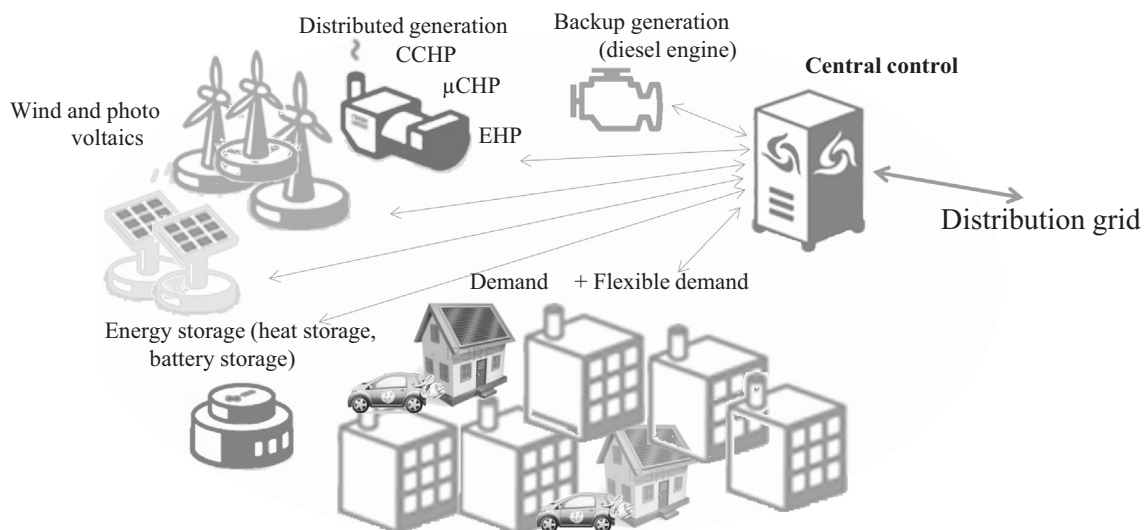

Fig. 1. Microgrid elements and the potential of connection of a multi-energy microgrid as a flexible multi-energy node through a PCC.

meaning that their moment-to-moment load balancing requests are less strict. Previous work of authors [36] demonstrates an adaptive receding horizon for re-dispatching MES units with the goal of minimizing deviations from the announced schedule as well as maximizing the usage of electricity locally generated from RES. However, it does not fully capture MES capability as it only analyses a specific microgrid environment and does not focus on estimating flexibility potential outside optimal energy provision. The value of re-dispatching capability is also recognized through the concept of MES profitability maps [37], however with no optimization through a receding horizon.

### 1.3. Contributions

This paper provides relevant contributions in quantifying flexibility capacities of multi-energy microgrid. For this purpose, an adaptive receding MILP optimization model is developed. The analyses focus on defining the impact of:

- (a) Different compositions of MEM. In particular, the benefits of decentralized MEM units compared to a single central energy community unit. All analyzed options provide electricity, heat and cooling to the final consumer, without diminishing their comfort, through different trigeneration unit technologies and belonging efficiencies.

- (b) Modelling aspects and approximations. The paper clearly demonstrated how common modelling approximations can be negligible in annual simulations (performed for planning purposes) but result in rather different short term operation states (analyses for day ahead scheduling). These approximations are of critical importance in assessing operational flexibility as they might lead to incorrect results and conclusions.
- (c) Both of the above aspects are evaluated through several defined MEM flexibility indicators, wasted heat and curtailed wind, considering operational techno-economic constraints of different microgrid components (battery storage, heat storage, micro combined heat and power units ( $\mu$ CHP) in off-grid (islanded) mode and interaction with the distribution system through the point of common coupling (PCC) in on-grid (parallel) mode.

The work presented here is a substantial extension of material presented by the authors in [38], however for easier understanding some of the model segments will be repeated and elaborated in the following sections.

## 2. Nomenclature and abbreviations

### Input parameters in order of appearance

$\tau$	Simulation time step duration (number of hour segments $\Delta T$ of an hour)	Section 3.0
$T$	Simulation duration [h]	Section 3.0
$t$	Current simulation step	Section 3.0
$i$	Counter referring to $i$ -th ho usehold	Section 3.0
$K$	Total number of households	Section 3.0
$\eta^{cchp\_e}$	Electricity production efficiency of the district CCHP unit [%]	Section 3.1
$\eta^{cchp\_h}$	Heat production efficiency of the district CCHP unit [%]	Section 3.1
$H_{max}^{CCHP}, H_{min}^{CCHP}$	Maximum/minimum output of the district CCHP unit [kW h]	Section 3.1
$ramp$	Ramping characteristic of the district CCHP unit [kW h/ $\Delta T$ ]	Section 3.1
$H_{max,i}^{CHP}, H_{min,i}^{CHP}$	Maximum/minimum heat output of a household $\mu$ CHP unit [kW h]	Section 3.2
$\eta_i^{chp\_e}$	Electricity production efficiency of household $\mu$ CHP unit [%]	Section 3.2
$\eta_i^{chp\_h}$	Thermal energy production efficiency of household $\mu$ CHP unit [%]	Section 3.2
$H_{max,i}^{EHP}$	Household EHP unit maximum thermal output [kW h]	Section 3.3
$COP_{t,i}$	Household EHP coefficient of performance	Section 3.3
$H_{max,i}^{ab}$	Household auxiliary boiler unit maximum heating output [kW h]	Section 3.4
$\eta^{AB}$	Household auxiliary boiler unit efficiency [%]	Section 3.4
$C_{max,i}^{hs}$	Household heat storage maximum capacity [kW h]	Section 3.4
$\lambda_i^{hs}$	Household heat storage unit hourly losses [%]	Section 3.4
$C_{max}^{TES}, C_{min}^{TES}$	District thermal energy storage maximum/minimum capacity [kW h]	Section 3.5
$\lambda^{TES}$	District thermal energy storage unit hourly losses [%]	Section 3.5
$C_{max}^{BAT}, C_{min}^{BAT}$	Central battery storage maximum/minimum capacity [kW h]	Section 3.6
$\eta_{BAT}^{ch}, \eta_{BAT}^{dch}$	Battery storage charge/discharge efficiency [%]	Section 3.6
$C_{max,i}^{BAT\_dist}, C_{min,i}^{BAT\_dist}$	Household battery unit maximum/minimum capacity [kW h]	Section 3.6
$\lambda^{BAT}$	Central battery storage self-discharge rate [%]	Section 3.6
$\lambda^{BAT\_dist}$	Distributed battery self-discharge rate [%]	Section 3.6
$Cool_{max}^{ABC}$	Absorption chiller maximum cooling output [kW h]	Section 3.7
$COP^{ABC}$	Coefficient of performance of absorption chiller	Section 3.7
$Cool_{max}^{EC}$	Electric (compression) chiller maximum cooling output [kW h]	Section 3.7

(continued)

## Input parameters in order of appearance

$COP^{EC}$	Coefficient of performance of electric (compression) chiller	Section 3.7
$Cool_{max,i}^{AC}$	Household AC unit maximum cooling output [kW h]	Section 3.7
$COP^{AC}$	Coefficient of performance of household air-condition (AC) unit	Section 3.7
$E_{max}^{DIESEL}$	Backup diesel generator maximum electricity output [kW h]	Section 3.8
$\eta^{DIESEL}$	Backup diesel generator efficiency [%]	Section 3.8
$C_{max}^{flex}$	Maximum capacity of flexible demand being rescheduled [%]	Section 3.9
$p^{flex}$	Percentage of total electrical demand regarded as flexible demand [%]	Section 3.9.
$E_t^{wind}$	Average hourly wind production of 1 kW installed capacity [kW h]	Section 3.9
$E_t^{PV}$	Average hourly PV production of 1 kW installed capacity [kW h]	Section 3.9
$H_{t,i}^d$	Household heat demand [kW h <sub>t</sub> ]	Section 3.10
$E_{t,i}^d$	Household electricity demand [kW h <sub>e</sub> ]	Section 3.10
$Cool_{t,i}^d$	Household cold demand [kW h <sub>e</sub> ]	Section 3.10
$EM_t$	Average emissions for electricity production [g/kW h]	Section 3.11
$EM^{ng}$	Natural gas average emission[g/kW h]	Section 3.11
$c^{ng}$	Natural gas supply price [€/kW h]	Section 4.0
$c^{diesel}$	Diesel supply price [€/kW h]	Section 4.0
$c^{fuel}$	District CCHP unit fuel supply price [€/kW h]	Section 4.0
$c_t^{imp}, c_t^{exp}$	Electricity price [€/kW h]	Section 4.0
$M^{sell}, M^{buy}$	Imbalance price modification factors	Section 4.0
$p^{heat}, p^{wind}$	Inhibiting factor for waste of heat and curtailment of wind	Section 4.0

## Decision variables in order of appearance

$H_t^{CCHP}$	Heat output of the district CCHP unit [kW h]	Section 3.1
$E_t^{CCHP}$	Electricity output of the district CCHP unit [kW h]	Section 3.1
$H_t^{binCCHP}$	Binary variable for the operational state of the CCHP unit	Section 3.1
$H_t^{startupCCHP}$	Binary variable for the startup signal of the CCHP unit	Section 3.1
$F_t^{CCHP}$	Fuel intake consumption of the district CCHP unit [kW h]	Section 3.1
$H_{t,i}^{CHP}$	Heat output of the household $\mu$ CHP unit [kW h]	Section 3.2
$H_{t,i}^{binCHP}$	Binary variable for the operational state of the household $\mu$ CHP unit	Section 3.2
$E_{t,i}^{CHP}$	Electricity output of the household $\mu$ CHP unit [kW h]	Section 3.2
$F_{t,i}^{CHP}$	Fuel intake consumption of the household $\mu$ CHP unit [kW h]	Section 3.2
$H_{t,i}^{EHP}$	Household EHP unit thermal power output [kW h]	Section 3.3
$E_{t,i}^{EHP}$	Household EHP unit electrical power output [kW h]	Section 3.3
$H_{t,i}^{binEHP}$	Household EHP unit thermal power binary variable	Section 3.3
$Cool_{t,i}^{EHP}$	Household EHP unit cooling power output [kW h]	Section 3.3
$Cool_{t,i}^{binEHP}$	Household EHP unit cooling power binary variable	Section 3.3
$H_{t,i}^{AB}$	Household auxiliary boiler unit heat production [kW h]	Section 3.4
$fuel_t^{AB\_total}$	Household auxiliary boiler units total fuel usage [kW h]	Section 3.4
$H_{t,i}^{hs}$	Household heat storage net heat flow[kW h]	Section 3.4
$C_{t,i}^{hs}$	Household heat storage capacity at simulation step $t$ [kW h]	Section 3.4
$C_t^{TES}$	District thermal energy storage capacity at simulation step $t$ [kW h]	Section 3.5
$H_t^{CCHP\_TES}$	Heat flow to district TES from CCHP unit [kW h]	Section 3.5
$H_t^{TES}$	Heat flow from TES to consumers [kW h]	Section 3.5
$E_t^{BAT\_ch}$	Central battery storage charging power [kW h]	Section 3.6
$E_t^{binBAT\_ch}$	Central battery storage charging power binary variable	Section 3.6
$E_t^{BAT\_dch}$	Central battery storage discharging power [kW h]	Section 3.6
$E_t^{binBAT\_dch}$	Central battery storage discharging power binary variable	Section 3.6
$C_t^{BAT}$	Central battery storage capacity [kW h]	Section 3.6

(continued on next page)

(continued)

Input parameters in order of appearance		
$E_{t,i}^{BAT\_ch}$	Household battery unit charging power [kW h]	Section 3.6
$E_{t,i}^{binBAT\_ch}$	Household battery unit charging power binary variable	Section 3.6
$E_{t,i}^{BAT\_dch}$	Household battery unit discharging power [kW h]	Section 3.6
$E_{t,i}^{binBAT\_dch}$	Household battery unit discharge power binary variable	Section 3.6
$C_{t,i}^{BAT\_dist}$	Household battery unit capacity [kW h]	Section 3.6
$Cool_t^{ABC}$	Absorption chiller cooling output [kW h]	Section 3.7
$Cool_t^{EC}$	Electric (compression) chiller cooling output [kW h]	Section 3.7
$Cool_{t,i}^{AC}$	Household AC unit cooling output [kW h]	Section 3.7
$E_t^{DIESEL}$	Backup diesel generator electricity output [kW h]	Section 3.8
$E_t^{binDIESEL}$	Backup diesel generator operational binary variable [kW h]	Section 3.8
$E_t^{startupDIESEL}$	Backup diesel generator startup binary variable [kW h]	Section 3.8
$E_t^{flex}$	Flexible demand being rescheduled [kW h]	Section 3.9
$E_t^{wind\_real}$	Produced energy from wind [kW h]	Section 3.9
$E_t^{wind\_curt}$	Curtailed wind energy [kW h]	Section 3.9
$X^{wind}$	Installed wind power capacity [kW]	Section 3.9
$X^{PV}$	Installed PV capacity [kW]	Section 3.9
$F_t^{ng}$	Total natural gas energy consumed [kW h]	Section 3.11
$F_t^{DIESEL}$	Total diesel fuel energy consumed [kW h]	Section 3.11
$long_t^{imp}$	Positive mismatch in import compared to day-ahead contracted exchange [kW h]	Section 4.0
$long_t^{exp}$	Positive mismatch in export compared to day-ahead contracted exchange [kW h]	Section 4.0
$short_t^{imp}$	Negative mismatch in import compared to day-ahead contracted exchange [kW h]	Section 4.0
$short_t^{exp}$	Negative mismatch in export compared to day-ahead contracted exchange [kW h]	Section 4.0
<b>Abbreviations</b>		
RES	Renewable Energy Sources	Section 1.1
MEM	Multi-energy Microgrid	Section 1.1
$\mu$ CHP	Micro Combined Heat and Power	Section 1.3
MILP	Mixed Integer Linear Programming	Section 1.3
COP	Coefficient of Performance	Section 3.0
CCHP	Combined Cooling, Heat and Power (trigeneration)	Section 3.0
EHP	Electric Heat Pump	Section 3.0
PV	Photovoltaic	Section 3.0
AB	Auxiliary Boiler	Section 3.4
TES	Thermal Energy Storage	Section 3.5
RH-MPC	Receding Horizon Model Predictive Control	Section 4.0

### 3. Multi-energy microgrid modelling

The model of multi-energy microgrid includes all relevant components to analyze the interactions between the elements and energy vectors. The developed model in this paper, as mentioned before, presents a substantial expansion of the work done in [38]. The residential community model can consist of any number of households and each household can be equipped with different energy sources and has various demand curves (heating, cooling and electricity). Depending on the microgrid configuration each household is supplied by either district CCHP or household  $\mu$ CHP unit, district ground source EHP or household air-water EHP unit (cooling and heating) with addition of household auxiliary boilers, household heat storages, battery storages and household installed RES units (PV panels). Additionally, the model considers flexible demand response and operation of a central battery storage. The model is easily expandable and new additional elements (e.g. electric vehicles) can be added. For the test-case analysis purposes size of the microgrid community has been chosen to consist of 300 households. The model relies on the following assumptions:

- Sampling time is constant (simulation time step  $\tau$  which enables a clear connection between power and produced energy and that way the model is able to capture different time step resolutions);
- Flexible consumers' response in rescheduling their demand is not compensated and that financial aspect is not accounted for;
- Developed MEM model assumes the microgrid is not big enough to be considered as price-maker;
- MEM operation is considered just from market perspective where voltage and frequency stability issues are not regarded;
- No communications error or delay was considered for the central controller, which is assumed to have all needed data available;

The schematic diagram of modelled MEM is shown in Fig. 2 for scenario where all elements are installed on a household level. The blue arrow represents the flow of electrical energy. Yellow arrow represents the heat energy flow. Green arrow represents flow of

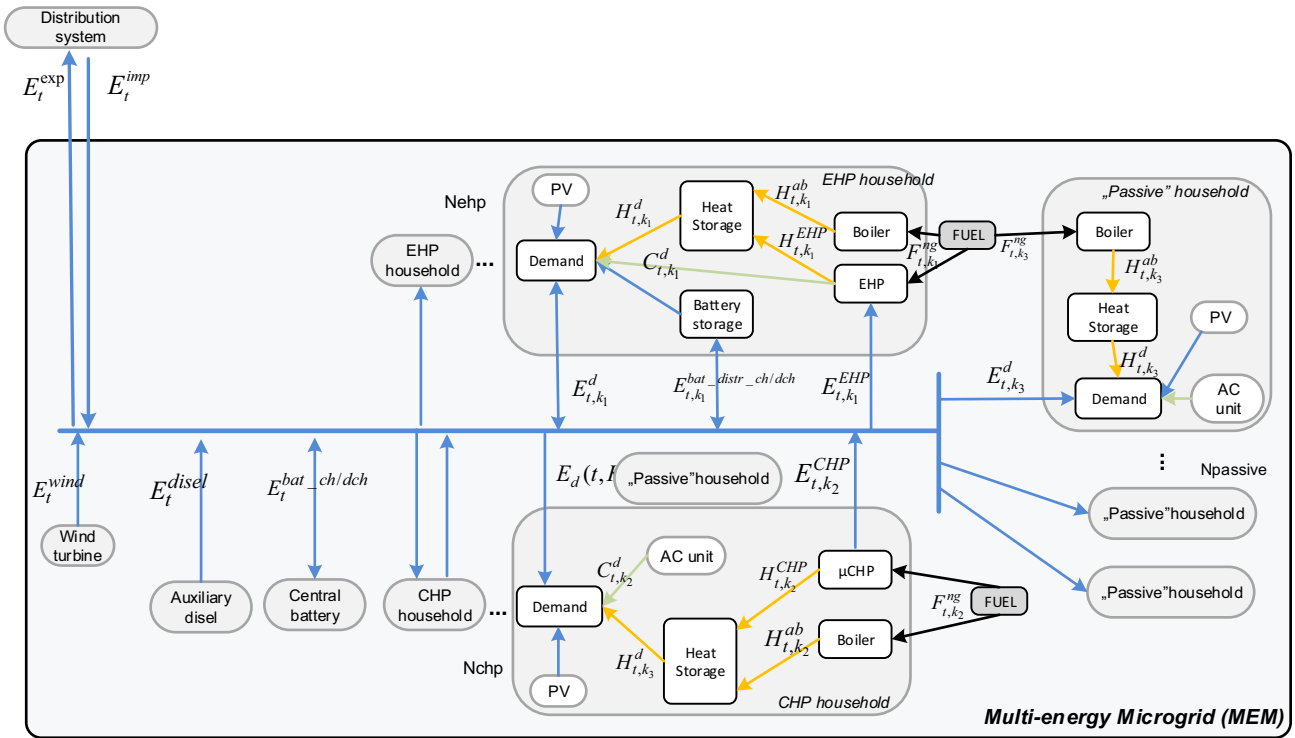

Fig. 2. MEM model schematic for proposed distributed household configuration.

cooling energy. Red arrow shows natural gas flows, and central bus in the first case represents electrical network. The flexibility potential is unlocked through the electrical grid when the operation of, for example,  $\mu$ CHP and EHP is coupled.

The concept of installing larger, central district units is shown in Fig. 3. The central bus represents the district heating/cooling network and electrical network. Different combinations of district and household elements are also possible.

Multi-energy microgrid elements can be installed on the household level in distributed manner (smaller units) or they can be centralized on the district level (larger units) as mentioned before. For the purpose of this paper, the following MEM configuration are selected and shown in Table 1.

Type 1 assumes all elements are installed on the household level: local EHP (Electric Heat Pumps) and  $\mu$ CHP (micro Combined Heat and Power units). Type 2 assumes centralized heat and elec-

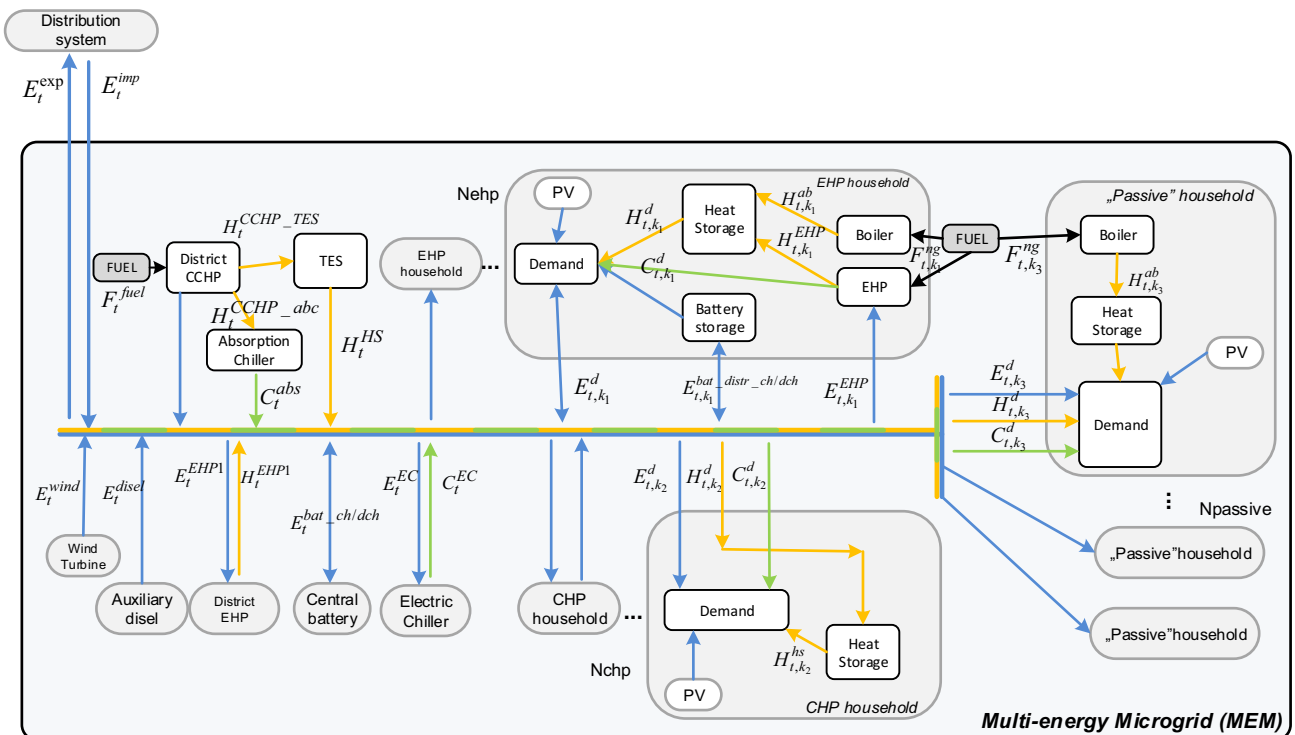

Fig. 3. MEM model schematic for proposed centralized district configuration.

**Table 1**  
Proposed different structures of multi-energy microgrid.

Microgrid configuration suggestion	CHP		EHP		Thermal storage		Battery storage		Chillers	Backup diesel	RES	
	District	House.	District	House	District	House.	District	House.			PV	Wind
Type 1 – distributed	–	✓	–	✓	–	✓	–	✓	–	–	✓	✓
Type 2 – centralized	✓	–	✓	–	✓	–	✓	–	✓	✓	✓	✓
Type 3 – CCHP+ household EHP	✓	–	–	✓	✓	✓	✓	–	✓	–	✓	✓
Type 4 – district EHP+ $\mu$ CHP	–	✓	✓	–	–	✓	–	✓	–	✓	✓	✓

tricity production in a district CCHP unit. Type 3 assumes that a certain share of households is supplied by centralized CCHP (Combined Cooling Heat and Power) and this share is equal to households supplied by  $\mu$ CHP and boiler in Type 1 while the remainder of households still use local EHP as a primary energy source. Type 4 assumes part of households uses district EHP while the remainder keeps  $\mu$ CHP and boiler as electricity/heating source.

Efficiencies of selected production units' efficiencies have significant impact MEM operation. These units, such as  $\mu$ CHP, CCHP and EHP units are modelled in two ways:

- (1) Typical efficiency approximations modelling approach, presented as a single constant value (COP for EHP, thermal and electrical efficiency for  $\mu$ CHP/CCHP unit).
- (2) Varying efficiency (varying COP, efficiency curves for  $\mu$ CHP/CCHP depending on loading).

More detailed models increase the computational times and in some cases they are not justified [39,40] but even a slight increase in accuracy results in significant differences, as it will be shown in the results section.

### 3.1. Combined cooling, heat and power (CCHP) units

For the district CCHP units, different installed capacities can be considered. The production of heat and power is coupled. The productions of heat and power are defined at each time step starting from the fuel input  $F_t^{CHP1}$  through relevant thermal efficiency  $\eta_{chp,h1}$  and electrical efficiency  $\eta_{chp,e1}$ . For  $\mu$ CHP and smaller CCHP units electrical and thermal efficiencies, as mentioned before, are typically a function of the loading curve. This aspect is often, for the sake of simplicity, not regarded and the approximation stating that efficiencies are constant is commonly made [41–43].

$$E_t^{CCHP} = F_t^{CCHP} \cdot \eta^{cchp-e} \quad (1)$$

$$H_t^{CCHP} = F_t^{CCHP} \cdot \eta^{cchp-h} \quad (2)$$

This means the connection between production of heat and electricity can be expressed as shown by Eq. (3) if constant efficiencies are considered:

$$E_t^{CCHP} = \frac{H_t^{CCHP} \cdot \eta^{cchp-e}}{\eta^{cchp-h}} \quad (3)$$

The CCHP thermal output is limited by the upper limit  $H_{max}^{CCHP}$  which represents its maximum output power, and its lower operating limit  $H_{min}^{CCHP}$  which can be considered as minimum stable generation point (MSG). The binary variable  $H_t^{binCCHP}$  indicates the unit is operational if its value is 1, and that unit is off if the value is 0. The CCHP production is bounded by its upper and lower limit expressed as:

$$H_t^{binCCHP} \cdot H_{min}^{CCHP} / \tau \leq H_t^{CCHP} \leq H_t^{binCCHP} \cdot H_{max}^{CCHP} / \tau \quad (4)$$

Startup binary logic is expressed as shown by Eq. (5).

$$H_t^{startCCHP} = H_t^{binCCHP} - H_{t-1}^{binCCHP} \quad (5)$$

For smaller units considered in this paper (power output in range of e.g. 1000 kW) the minimum up time and minimum off time can be neglected and is not considered.

Since thermal power plants like considered district CCHP unit typically exhibit variations in power output, ramping constraints that limit the output increase or decrease between two successive time periods is added (Eq. (6)). Constraint *ramp* is expressed in comparison to maximum output power as  $H_{max}^{CCHP} / \tau$ .

$$-ramp \leq H_t^{CCHP} - H_{t-1}^{CCHP} \leq ramp \quad (6)$$

If more detailed model is considered regarding the efficiency of operation the mathematical model for this mode 2 of operation is extended and therefore Eqs. (2) and (3) that model the output power are substituted by the following formulations (Eqs. (7) and (8)) that have an aim to capture the non-linear behavior of the efficiencies.

$$E_t^{CCHP} = F_t^{CCHP} \cdot \eta^{cchp-e} + H_t^{binCCHP} \cdot \eta^{cchp-e'} \quad (7)$$

$$H_t^{CCHP} = F_t^{CCHP} \cdot \eta^{cchp-h} + H_t^{binCCHP} \cdot \eta^{cchp-h'} \quad (8)$$

The efficiencies are modelled as linear approximations while full-load efficiency is considered to be the same for both modes of operation. The coefficient  $\eta_{chp,e1}, \eta_{chp-e1}'$  and  $\eta_{chp,h1}, \eta_{chp-h1}'$  for units of different sizes have different values in order to preserve the same efficiency curve shape with respect to part-load operation conditions. For example, the unit of maximum power (fuel intake maximum limit) of 2000 kW the coefficient values are  $\eta^{cchp-e} = 0.37, \eta^{cchp-e'} = -107, 42$  and  $\eta^{cchp-h} = 0.65, \eta^{cchp-h'} = -197, 10$ . For 1000 kW the values are  $\eta^{cchp-e} = 0.42, \eta^{cchp-e'} = -90, 43$  and  $\eta^{cchp-h} = 0.70, \eta^{cchp-h'} = -147, 90$ , describing the efficiency of Capstone units [44].

The CCHP units usually have two operating modes, namely electricity following and heat/cooling demand following [45]. This paper assumes heat/cooling following mode of operation.

### 3.2. Micro Combined heat and power ( $\mu$ CHP) units

Distributed  $\mu$ CHP units are installed in a number of households, depending on the scenario. In Eq. (9) the coefficient  $\tau$  is a time step and used as a direct connection between power and energy. The  $\mu$ CHP units considered in this work have installed capacity of 8 kW<sub>t</sub> and technical minimum of 1.6 kW<sub>t</sub>.

$$H_{t,i}^{binCHP} \cdot H_{min,i}^{CHP} \cdot \tau \leq H_{t,i}^{CHP} \leq H_{t,i}^{binCHP} \cdot H_{max,i}^{CHP} \cdot \tau \quad (9)$$

It is assumed these micro units can adjust their power fast enough and therefore no ramping constraints have been added. As a reference Capstone units C30 and C200 were used [46–48]. The tests have shown that these units are characterized by under 120 s response in start, stop and power adjustments, while the shutdown process is over in 200 s. This also means that for the time frame considered in this paper, these constraints can be neglected [49].



Again  $\mu$ CHP units are modelled in two ways with respect to the efficiency. The first is the constant efficiency according to which the output of  $i$ -th  $\mu$ CHP is:

$$E_{t,i}^{CHP1} = \frac{H_{t,i}^{CHP1} \cdot \eta_i^{chp-e}}{\eta_i^{chp-h}} \quad (10)$$

Total fuel (natural gas) consumption of all  $\mu$ CHP in heat following mode is:

$$fuel_t^{CHP\_total} = \sum_i^K \frac{H_{t,i}^{CHP}}{\eta_i^{chp-h}} \quad (11)$$

The second mode assumes variable efficiency depending on the loading conditions.

$$E_{t,i}^{CHP} = F_{t,i}^{CHP} \cdot \eta_i^{chp-e} + H_{t,i}^{binCHP} \cdot \eta_i^{chp-e'} \quad (12)$$

$$H_{t,i}^{CHP} = F_{t,i}^{CHP} \cdot \eta_i^{chp-h} + H_{t,i}^{binCHP} \cdot \eta_i^{chp-h'} \quad (13)$$

The coefficient values for electrical output are  $\eta_i^{chp-e} = 0.55$ ,  $\eta_i^{chp-e'} = 4.51$  making the approximations close to the Capstone commercial unit (Fig. 4).

### 3.3. Electric heat pump (EHP) units

Similar to CHP, both local and district EHP units are considered as energy providers. In the model a number of households use heat generated by EHP as a main heat and cooling source. Eq. (14) describes the relation between the current heat output and electricity consumption for a household unit and Eq. (14) describes the relation for larger EHP unit.

$$H_{t,i}^{EHP} = E_{t,i}^{EHP} \cdot COP_t \quad (14)$$

$$H_t^{EHP} = E_t^{EHP} \cdot COP_t \quad (15)$$

EHP heat and cooling productions are limited by their upper and lower boundaries [43]. The electric heat pump can operate in either cooling or heating mode while the maximum output power is assumed to be similar [50] and modelled by Eq. (18).

$$0 \leq H_{t,i}^{EHP} \leq H_{max,i}^{EHP} \cdot \tau \cdot H_{t,i}^{EHPbin} \quad (16)$$

$$0 \leq Cool_{t,i}^{EHP} \leq Cool_{max,i}^{EHP} \cdot \tau \cdot Cool_{t,i}^{EHPbin} \quad (17)$$

$$H_{t,i}^{EHPbin} + C_{t,i}^{EHPbin} \leq 1 \quad (18)$$

For household units air-water type of electric heat pump is assumed. Its efficiency ratio depends on the outdoor temperature and temperature difference between outside air and heated space. Diplex and Acadia heat pumps were used as a reference [50,51]. The assumed type of central EHP is ground source. The COP also depends on loading conditions [52] but the effect of temperature difference is much more significant [53,54].

Ground source heat pumps demonstrate higher COP compared to smaller air-water heat pumps and their COP is less variable between seasons and throughout the day.

### 3.4. Household auxiliary boiler (AB) units and household heat storage (HS) units

Households that have no other active heat source are equipped with boiler units as primary source of heat while houses with  $\mu$ CHP and EHP have boilers as a backup option. The boilers are fueled by natural gas and peak heat output power is 10 kW<sub>t</sub> with efficiency of fuel conversion 81%. The gas boiler could be substituted with the electricity boiler that consumes electric power to generate heat when load cannot be satisfied by CHP units for example. The efficiency of larger boiler units can also be modelled as constant or variable [55,56], but the assumption in this paper was that the smaller household boiler units operate with constant efficiency.

$$H_{t,i}^{AB} \leq H_{max,i}^{AB} \cdot \tau \quad (19)$$

$$fuel_t^{AB\_total} = \sum_i^K \frac{H_{t,i}^{AB}}{\eta^{AB}} \quad (20)$$

Furthermore, to increase the reliability of heat supply and overall flexibility, all household are equipped with a heat storage tank in form of a simple water tank. Assumed maximum storage capacity  $C_{max,i}^{hs}$  is 6 kW h which translates into approximately 0.15 m<sup>3</sup> water tank [57]. Total thermal energy available in the storage in each time step is expressed as thermal energy stored the previous time step plus the net heat thermal storage flow (Eq. (21)). The hourly losses  $\lambda_i^{hs}$  are assumed to be 4%.

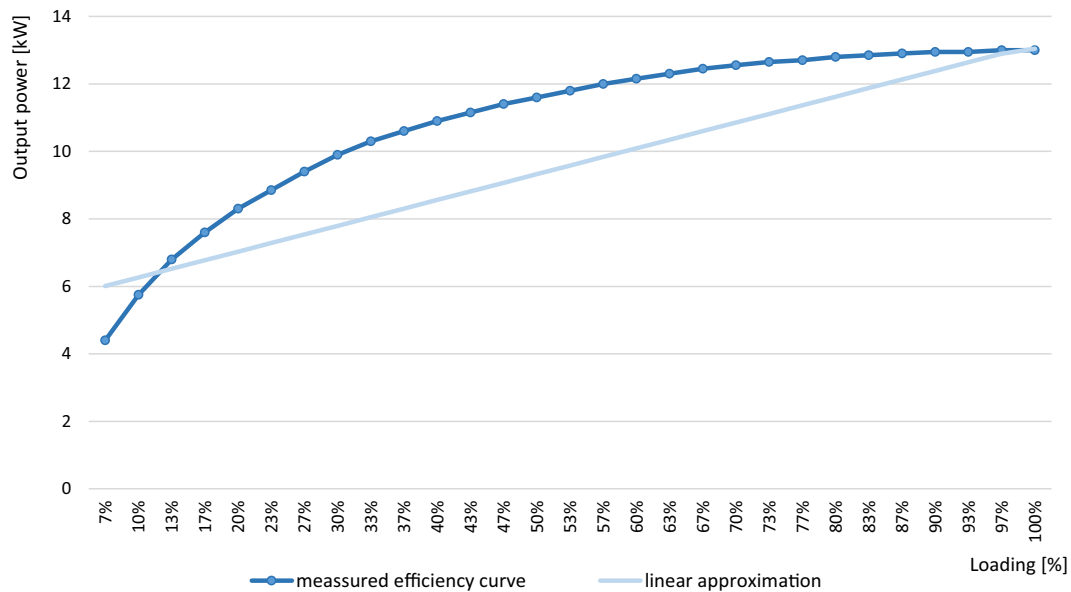

Fig. 4.  $\mu$ CHP unit variable efficiency linear approximation.

$$C_{t,i}^{hs} = (1 - \lambda_i^{hs}/\tau) \cdot C_{t-1,i}^{hs} - H_{t,i}^{hs} \quad (21)$$

The maximum heat storage capacity is limited (Eq. (22)) as well the charge/discharge time (Eq. (23))

$$C_{t,i}^{hs} \leq C_{\max,i}^{hs} \quad (22)$$

$$H_{t,i}^{hs} = C_{\max,i}^{hs} \cdot \tau \quad (23)$$

### 3.5. Central thermal energy storage (TES) unit

As stated before the electricity and heat energy generated by the CCHP units are coupled. In order to increase the flexibility of this district system, thermal energy storage is added. Similar sizing and modelling approach is taken as in [58]. The thermodynamic process of the heat flow in the heat storage is a complex process. More detailed models (e.g. stratified model) increase the complexity and computational burden, however simple models, that assume ideally mixed volume with homogeneous temperature, provide results that are precise enough [39]. The model used in this paper is described by the Eqs. (24), (25) and (26) which consider the intertemporal variable of storage capacity, charge/discharge and maximum capacity limit. The model is similar to commonly used models (e.g. [59]).

The charging flow is heat energy supplied by the CCHP unit and discharging flow is the heat supplied to the consumers.

$$C_t^{TES} = (1 - \lambda^{TES}/\tau) \cdot C_{t-1,i}^{TES} - H_t^{TES} + H_t^{CCHP\_TES} \quad (24)$$

$$C_{\min}^{TES} \cdot 2\tau \leq H_t^{TES} \leq C_{\max}^{TES} \cdot 2\tau \quad (25)$$

$$C_{\min}^{TES} \cdot \tau \leq C_t^{TES} \leq C_{\max}^{TES} \cdot \tau \quad (26)$$

Hourly losses  $\lambda_i^{TES}$  are assumed to be 0.1% (total water volume  $\approx 200 \text{ m}^3$ ) and 80% is assumed for a cycle efficiency. Initial thermal energy storage capacity is assumed to be  $C_{\max}^{TES}/4$ .

### 3.6. Battery storage

#### 3.6.1. Central battery storage

The battery for a central model is incorporated with the following equations (Eqs. (27)–(30)). Maximum value of energy flow through battery (charge/discharge) at any given time step is limited and connected with the maximum capacity of the battery (Eq. (27)). It is assumed that, for example, in a time simulation step of a half an hour the battery can be charged to one eighth of its capacity. The binary logic that ensures both charge and discharge cannot occur at the same time is expressed as Eq. (29). Battery capacity is limited with its maximum capacity and minimum capacity to prevent deep discharging (Eq. (30)).

$$0 \leq E_t^{BAT\_ch} \leq C_{\max}^{BAT}/(\tau \cdot 4) \cdot E_t^{binBAT\_ch} \quad (27)$$

$$0 \leq E_t^{BAT\_dch} \leq C_{\max}^{BAT}/(\tau \cdot 4) \cdot E_t^{binBAT\_dch} \quad (28)$$

$$E_t^{binBAT\_dch} + E_t^{binBAT\_ch} \leq 1 \quad (29)$$

$$C_{\min}^{BAT} \leq C_t^{BAT} \leq C_{\max}^{TES} \quad (30)$$

The capacity of central battery between two successive time steps changes according to Eq. (31). Self-discharging loss ( $\lambda^{BAT}$ ) is regarded as the loss of 0.005% of stored energy per hour.

$$C_t^{BAT} = (1 - \lambda^{BAT} \cdot \tau) \cdot C_{t-1}^{BAT} + E_t^{BAT\_ch} \cdot \eta_{BAT}^{ch} + E_t^{BAT\_dch} / \eta_{BAT}^{dch} \quad (31)$$

#### 3.6.2. Household battery storage

On the other hand, the battery model for the batteries distributed among households (K is the number of households) is described with the following constraints:

$$0 \leq E_{t,i}^{BAT\_ch} \leq C_{\max,i}^{BAT\_dist}/(\tau \cdot 4) \cdot E_{t,i}^{BAT\_chbin} \quad (32)$$

$$0 \leq E_{t,i}^{BAT\_dch} \leq C_{\max,i}^{BAT\_dist}/(\tau \cdot 4) \cdot E_{t,i}^{BAT\_dchbin} \quad (33)$$

$$E_{t,i}^{BAT\_dchbin} + E_{t,i}^{BAT\_chbin} \leq 1 \quad (34)$$

$$C_{\min}^{BAT\_dist} \leq C_t^{BAT\_dist} \leq C_{\max}^{BAT\_dist} \quad (35)$$

$$C_t^{BAT\_dist\_total} = \sum_i^K C_{t-1,i}^{BAT\_dist} (1 - \lambda^{BAT\_dist} \cdot \tau) \cdot C_{t-1,i}^{BAT\_dist} + E_{t,i}^{BAT\_dist\_ch} \cdot \eta_{BAT}^{ch} + E_{t,i}^{BAT\_dist\_dch} / \eta_{BAT}^{dch} \quad (36)$$

### 3.7. Cooling energy sources

For the cooling demand several units are available.

#### 3.7.1. Absorption chiller (ABC)

The absorption chiller is used to convert heat generated by the CCHP unit into cooling energy to meet the cooling demand (Eq. (37)). COP of absorption chiller describes its efficiency.  $COP^{ABC}$  used in this paper has a value of 1.1 which is relatively low compared to COP of electric heat pumps for example. But absorption chiller still provides an efficient solution to provide cooling energy since can use the heat produced by CCHP unit that would otherwise not be used for any other purpose.

$$Cool_t^{ABC} = H_t^{CCHP\_ABC} \cdot COP^{ABC} \quad (37)$$

$$0 \leq Cool_t^{ABC} \leq Cool_{\max}^{ABC} \quad (38)$$

#### 3.7.2. Electric (compression) chiller (EC)

The electric chiller is driven by electrical power to produce cooling energy. (Eq. (39)). COP of electric chiller  $COP^{EC}$  is much higher compared to absorption chiller. The value used in this paper is 3.5.

$$Cool_t^{EC} = E_t^{EC} \cdot COP^{EC} \quad (39)$$

$$0 \leq Cool_t^{EC} \leq Cool_{\max}^{EC} \quad (40)$$

#### 3.7.3. Air condition (AC) units

Households in a distributed manner have installed AC units as a source of cooling energy if that energy is not provided by other source (e.g. EHP). AC units are modelled in a simple way; the input electricity is converted to output cooling with the coefficient of performance  $COP^{AC}$  equal to 2.7 (efficiency of conversion of electricity consumption to cooling: output cooling energy/input electrical energy).

$$Cool_{t,i}^{AC} = E_{t,i}^{AC} \cdot COP^{AC} \quad (41)$$

$$0 \leq Cool_{t,i}^{AC} \leq Cool_{\max,i}^{AC} \quad (42)$$

### 3.8. Backup diesel generator

Backup diesel generator is modelled in case there is not enough electricity capacity (which can sometimes happen in off-grid

mode) but the startup of this unit is expensive and preferably avoided. The output electrical power of backup diesel generator is limited by its maximum and minimum power (Eq. (43))

$$E_t^{binDIESEL} \cdot E_{min}^{DIESEL} / \tau \leq E_t^{DIESEL} \leq E_t^{binDIESEL} \cdot E_{max}^{DIESEL} / \tau \quad (43)$$

$$H_t^{startupDIESEL} = H_t^{binDIESEL} - H_{t-1}^{binDIESEL} \quad (44)$$

Fuel consumption cost is calculated as input fuel energy divided by energy value of a kilogram of diesel fuel (11.94 kW/kg) multiplied by its price.

$$diesel_t = \frac{1/\eta^{DIESEL} \cdot E_t^{DIESEL}}{11.94} \cdot c^{DIESEL} \quad (45)$$

### 3.9. Flexible electrical demand and renewable energy sources (RES)

#### 3.9.1. Flexible demand

Percentage of total load that can provide fast response flexible demand is included in MEM model in a simplified way. The percentage  $p_{flex}$  is set to be 10% of  $E_d$  in all simulation steps.  $E_t^{flex}$  is positive for load reduction (“production” effect) and negative for load increase (“consumption effect”).

$$-p^{FLEX} \cdot E_t^{d\_total} \leq \sum_i^K E_{t,i}^{flex} \leq p^{FLEX} \cdot E_t^{d\_total} \quad (46)$$

To ensure that rescheduled demand does not exceed certain limit, the information about the total amount of shiftable loads that are being rescheduled at every time step is preserved in continuous decision variable for flexible demand total capacity (Eqs. (47) and (48)).

$$-C_t^{flex\_max} / \tau \leq \sum_i^K C_{t,i}^{flex} \leq C_t^{flex\_max} / \tau \quad (47)$$

$$C_{t,i}^{flex} \leq C_{t-1,i}^{flex} - E_{t,i}^{flex} \quad (48)$$

#### 3.9.2. Photovoltaics production (PV) and wind turbine (WT) generation

The production of PV arrays ( $E_t^{PV\_real}$ ) depends on the input data (averaged production of 1 kW installed solar energy). The wind production is modelled similarly, with the yearly input data of a real 1 kW wind power plant (scaled), with the difference that wind can be curtailed:

$$E_t^{wind\_curt} + E_t^{wind\_real} = E_t^{wind} \quad (49)$$

Additionally, developed model has the ability to determine optimal installed capacities of RES, which is the total amount of

PV and wind that can be seamlessly integrated into the MEM. Therefore, the productions are modified with decision variable representing installed RES capacity:

$$E_t^{wind\_real} = E_t^{wind} \cdot X^{wind} \quad E_t^{PV\_real} = E_t^{PV} \cdot X^{PV} \quad (50)$$

### 3.10. Demand (heat, cooling and electricity)

#### 3.10.1. Heat demand

Heat demand is modelled with different daily curves for different seasons extracted from data available for United Kingdom [60]. The curves are evenly distributed among all households. In scenario with all units being local household level units, the demand needs to be satisfied according to the following equation:

$$H_{t,i}^d \leq H_{t,i}^{CHP} + H_{t,i}^{EHP} + H_{t,i}^{AB} + H_{t,i}^{HS} \quad (51)$$

If MEM configuration with district level units (CCHP or district EHP for example), total demand is met in accordance to the Eq. (52) where houses that do not have access to district system supply themselves locally as shown in (Eq. (51)), while district heat balance is maintained.

$$H_t^{d\_tot} \leq H_t^{TES} + H_t^{EHP} + H_t^{CHP\_total} + H_t^{EHP\_total} + H_t^{AB\_total} + H_t^{HS} \quad (52)$$

$H_t^{CHP\_total}$  is summation of production of all  $\mu$ CHP units installed in corresponding households. To ensure safe operation of MEM in every simulation step heat waste is allowed:

$$H_t^{waste} \leq H_t^{d\_tot} - (H_t^{CCHP} - H_t^{CCHP\_ABC} - H_t^{CCHP\_TES} + H_t^{EHP} + H_t^{CHP\_total} + H_t^{EHP\_total} + H_t^{AB\_total} + H_t^{HS\_total}) \quad (53)$$

#### 3.10.1. Cooling demand

Similar to heating demand, cooling demand is modelled with different demand curves evenly distributed among households. The total cooling demand is met by the production from absorption chiller, electric chiller, household EHP units and household AC units. Effectively, wasted cold is potential excess heat generated by the CCHP plant that could have been used by the absorption chiller or heat storage.

$$Cool_{t,i}^d \leq Cool_{t,i}^{ABC} + Cool_t^{EC} + Cool_t^{EHP\_total} + Cool_t^{AC\_total} \quad (54)$$

#### 3.10.2. Electricity demand

Electricity demand is represented by different profiles for different seasons based on UK data [60]. All households have access to electrical network and equilibrium between production and consumption has to be constantly maintained (Eq. (55)).

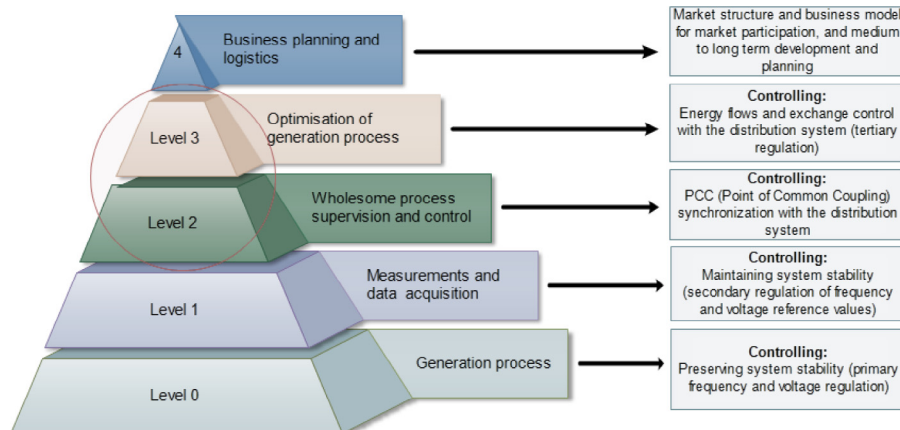

Fig. 5. IEC/ISA 95 standard hierarchy control adjusted for the observed MEM concept.

$$\begin{aligned}
& E_i^{d\_tot} + E_t^{exp} + E_t^{EC} + E_t^{EHP} + E_t^{BAT\_ch} + \sum_i^K E_{t,i}^{EHP} + \sum_i^K E_{t,i}^{BAT\_ch} + \sum_i^K \\
& E_{t,i}^{AC} = E_t^{imp} + E_t^{PV\_real} + E_t^{wind\_real} + E_t^{BAT\_dch} + E_t^{diesel} + \sum_i^K E_{t,i}^{flex} \\
& + \sum_i^K E_{t,i}^{CHP} + \sum_i^K E_{t,i}^{BAT\_dch}
\end{aligned} \quad (55)$$

### 3.11. CO<sub>2</sub> Emissions

Emissions are calculated as in Eq. (43). The emission factors for natural gas, diesel are considered to be constant for energy unit of fuel consumed, while the exchange energy (electricity import/export) equivalent emission are calculated based on average emissions for UK system [61] for electricity generation of each hour.

$$\begin{aligned}
emissions_t = & F_t^{ng} \cdot EM^{ng} + F_t^{CCHP} \cdot EM^{CCHP} + F_t^{DIESEL} \cdot EM^{DIESEL} \\
& + E_t^{imp} \cdot EM_t + E_t^{exp} \cdot EM_t
\end{aligned} \quad (56)$$

$F_t^{ng}$  is the natural gas used by  $\mu$ CHP and auxiliary boiler units, while  $F_t^{CCHP}$  is the gas used by the district CCHP unit.

## 4. Formulation of the receding horizon corrective scheduling model

Trigeneration energy microgrid model described in the previous section is used to test the flexibility benefits of different MEM configurations under receding horizon corrective scheduling control framework.

Microgrid control can be observed as a hierarchical structure (Fig. 5) [62,63]. The lowest level is directly connected with the characteristics of the generator. The second level ensures the stabilization of frequency after the fluctuations. The developed model utilizes a central control system of higher level (Fig. 5– primarily level) with the assumption that the lower level control is efficiently implemented.

The controller for the receding horizon MEM scheduling uses model predictive control scheme (MPC). The basic idea of MPC control is shown in figure below (Fig. 6). The controller based on the reference model results decides on the desired MEM operation. The iterative process dealing with uncertainties runs the optimization with the updated information to MEM central controller/dispatcher. MEM operates according to the market signals, namely energy and balancing prices.

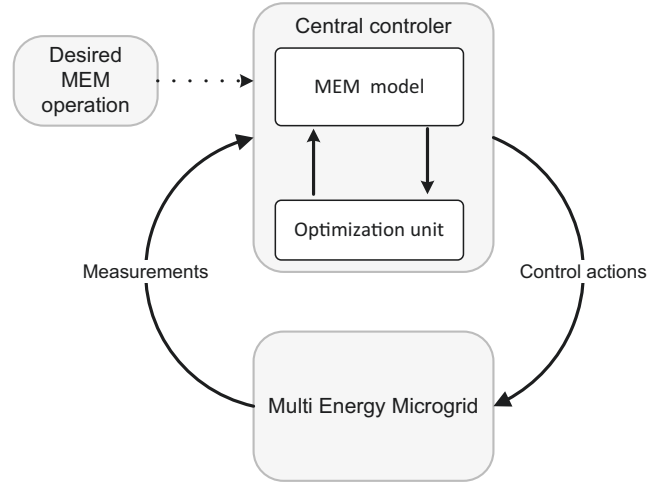

Fig. 6. Model predictive control concept applied to the developed MEM model.

- (1) At a certain moment during current day (e.g. 12 h ahead of delivery) MEM sends forecasted energy exchange for the next day at the PCC to the system operator. This exchange is the result of optimization where MEM is considered market price taker.
- (2) At the start of the following day (e.g. 00:00 AM) MEM enters the daily cycle where proposed receding horizon MPC algorithm adjusts the operational points of all units in order to follow as closely as possible the plan announced in step 1 by compensating mismatches. In case of deviations due to errors in demand and RES production forecasts, it optimally adjusts operating points of MEM to minimize penalties.

The proposed algorithm is used for correcting initially planned operational points of production units schedules (Corrective) in a manner that always looks ahead till end of the current daily cycle. This means that as the day progresses the corrections are being applied and iteratively planned just for a shortened (Receding) number of future time steps (Horizon) even though the algorithm even in the last time step includes most recent forecasts for the next daily cycle.

Objective function of the proposed MILP model is cast as operational cost minimization. The desired microgrid operation for the reference optimization is driven by the following equation:

$$\begin{aligned}
\text{minimize COST} = & \sum_{t=1}^{T_{\max}} \left( F_t^{ng} \cdot c^{ng} + F_t^{CCHP} \cdot c^{fuel} + F_t^{DIESEL} \cdot c^{diesel} + E_t^{imp} \cdot c_t^{imp} - E_t^{exp} \cdot c_t^{exp} \right. \\
& + P \cdot E_t^{wind\_cur} + P \cdot H_t^{waste} + H_t^{binCCHP} \cdot c_{const}^{CCHP} + H_t^{startupCCHP} \cdot c_{start}^{CCHP} \\
& \left. + E_t^{binDIESEL} \cdot c_{const}^{DIESEL} + E_t^{startupDIESEL} \cdot c_{start}^{DIESEL} \right)
\end{aligned} \quad (57)$$

For every simulation step  $t$  the control algorithm estimates the system state for the entire operational planning horizon ahead. On the basis of the present state and forecasts for the planning horizon the optimal state is determined. This way both the current state and the future forecast errors are included in the scheduling. More detailed description of the iterative MPC optimization process can be found in [36] or in further literature [64,65] or [66]. For the next simulation step the process is repeated and in each step participation on the balancing (intra-day) market is decided. The operating horizon for the rolling unit commitment model is 24 h which corresponds to the day-ahead scheduling. The most important steps of the optimization algorithm are:

After the initial (reference) run the algorithm uses modified objective function that calculates additional costs due to penalties cause by forecast errors. Index  $S$  marks current hour of the day,  $E_t^{imp0}$ ,  $E_t^{exp0}$  mark contracted import/export of electricity. Variable  $short_t^{imp}$  references to electricity import smaller than contracted due to forecast errors, while  $short_t^{exp}$  is defined for export smaller than contracted. Similarly,  $long_t^{imp}$  is defined for electricity import larger than contracted and  $long_t^{exp}$  is defined for positive mismatch in export (export larger than contracted). Factors  $M^{sell}$  and  $M^{buy}$  are reducing/increasing the market index price to obtain imbalance prices.  $M^{sell}$  is smaller than 1 and  $M^{buy}$  is larger than 1.

The first line of the objective function (Eq. (58)) models the expected cost for contracted exchange, second segment is mis-

line 3 are “shifted” into values in line 2, meaning all energy is delivered at the end of the day).

$$\begin{aligned}
 \text{COST} = & \sum_{t=1}^{24\cdot\tau+1-S} \left[ F_t^{\text{ng}} \cdot c^{\text{ng}} + F_t^{\text{CCHP}} \cdot c^{\text{fuel}} + F_t^{\text{DIESEL}} \cdot c^{\text{diesel}} + E_t^{\text{imp0}} \cdot c_t^{\text{mcp}} - E_t^{\text{exp0}} \cdot c_t^{\text{mcp}} + \right. \\
 & \left. P \cdot E_t^{\text{wind\_cur}} + P \cdot H_t^{\text{waste}} + H_t^{\text{binCCHP}} \cdot c_{\text{const}}^{\text{CCHP}} + H_t^{\text{startupCCHP}} \cdot c_{\text{start}}^{\text{CCHP}} \right. \\
 & \left. + E_t^{\text{binDIESEL}} \cdot c_{\text{const}}^{\text{DIESEL}} + E_t^{\text{startupDIESEL}} \cdot c_{\text{startup}}^{\text{DIESEL}} \right] \\
 & \left[ (-)\text{short}_t^{\text{imp}} \cdot M^{\text{sell}} \cdot c_t^{\text{mcp}} + \text{long}_t^{\text{imp}} \cdot M^{\text{buy}} \cdot c_t^{\text{mcp}} + \text{short}_t^{\text{exp}} \cdot M^{\text{buy}} \cdot c_t^{\text{mcp}} - \text{long}_t^{\text{exp}} \cdot M^{\text{sell}} \cdot c_t^{\text{mcp}} \right] + \\
 & + \sum_{t=24\cdot\tau+1-S}^{24\cdot\tau} \left[ F_t^{\text{ng}} \cdot c^{\text{ng}} + F_t^{\text{CCHP}} \cdot c^{\text{fuel}} + F_t^{\text{DIESEL}} \cdot c^{\text{diesel}} + E_t^{\text{imp}} \cdot c_t^{\text{imp}} - E_t^{\text{exp}} \cdot c_t^{\text{exp}} \right. \\
 & \left. + P \cdot E_t^{\text{wind\_cur}} + P \cdot H_t^{\text{waste}} + H_t^{\text{binCCHP}} \cdot c_{\text{const}}^{\text{CCHP}} + H_t^{\text{startupCCHP}} \cdot c_{\text{start}}^{\text{CCHP}} \right. \\
 & \left. + E_t^{\text{binDIESEL}} \cdot c_{\text{const}}^{\text{DIESEL}} + E_t^{\text{startupDIESEL}} \cdot c_{\text{startup}}^{\text{DIESEL}} \right]
 \end{aligned} \tag{58}$$

match penalty cost. The first two segments represent costs for realized hours of the ongoing day. The third segment represents predicted cost for upcoming hours of the ongoing day (notice that as the RH-MPC progresses closer to the end of the day, values in

All modelled element parameters are listed and explained in Table 2. Elements in different simulations have different installed capacities (e.g. TES capacity, household type, shares or households, battery storage capacity) due to different MEM configurations. For

**Table 2**  
Parameter values.

Parameter	Value [Unit]
Simulation time $T_{\text{max}}$	24–8760 [h]
Simulation time step duration $\tau$	2 (30 min) [hour segments]
Number of households in district MEM $K$	e.g. 300
Penalty factor for unused energy $P$	e.g. 300
Natural gas price $c^{\text{ng}}$	0.025 [€/kW h]
CCHP unit fuel gas price $c^{\text{cchp}}$	0.024 [€/kW h]
Diesel price $c^{\text{diesel}}$	0.037 [€/kW h]
Flexible demand share $p^{\text{flex}}$	10 [%]
Maximum flex demand capacity $C_{\text{max}}^{\text{flex}}$	50 [kW h]
Electric efficiency of $\mu$ CHP unit $\eta_i^{\text{chp-e}}$	24 [%]
Thermal efficiency of $\mu$ CHP unit $\eta_i^{\text{chp-h}}$	54 [%]
Electric efficiency of district CCHP unit $\eta_i^{\text{cchp-e}}$	32 [%]
Thermal efficiency of district $\mu$ CHP unit $\eta_i^{\text{cchp-h}}$	55 [%]
Maximum fuel intake power of district CCHP unit $H_{\text{max}}^{\text{CCHP}}$	1000 [kW h <sub>t</sub> ]
Maximum thermal output of district CCHP unit $H_{\text{max}}^{\text{CCHP}}$	≈550 [kW h <sub>t</sub> ]
Maximum thermal output of $\mu$ CHP unit $H_{\text{max},i}^{\text{CCHP}}$	8 [kW h <sub>t</sub> ]
Maximum thermal/cooling output of EHP unit $H_{\text{max},i}^{\text{EHP}}$	10 [kW h <sub>t</sub> ]
Maximum power output of EHP unit $H_{\text{max}}^{\text{EHP}}$	300 [kW h <sub>t</sub> ]
Share of households with CHP based heating	40 [%]
Share of households with EHP based heating	30 [%]
Share of households with only boiler based heating	30 [%]
Mean coefficient of performance for household EHP units $COP_t$	3.5 summer 3.0 inter (sprint, autumn) 2.5 winter
Coefficient of performance for district EHP unit $COP$	6.0 summer 5.0 inter (sprint, autumn) 4.5 winter
Maximum thermal output of a boiler unit $H_{\text{max},i}^{\text{AB}}$	10 [kW h <sub>t</sub> ]
Auxiliary boiler efficiency $\eta^{\text{AB}}$	85 [%]
District thermal energy storage maximum capacity $C_{\text{max}}^{\text{TES}}$	2000 [kW h <sub>t</sub> ]
Household heat storage maximum capacity $C_{\text{max},i}^{\text{hs}}$	6 [kW h <sub>t</sub> ]
Heat storage efficiency $\eta_{\text{hs}}$	98 [%]
Household battery storage maximum capacity $C_{\text{max},i}^{\text{bat}}$	4 [kW h <sub>e</sub> ]
Central battery storage maximum capacity $C_{\text{max}}^{\text{bat}}$	50 [kW h <sub>e</sub> ]
Maximum power output of a backup diesel unit $H_{\text{max},i}^{\text{AB}}$	50 [kW h <sub>t</sub> ]
Backup diesel efficiency $\eta^{\text{AB}}$	33 [%]
Coefficient of performance of electric chiller $COP^{\text{EC}}$	3.5 [–]
Coefficient of performance of absorption chiller $COP^{\text{AC}}$	1.2 [–]
Coefficient of performance of household AC unit $COP_i^{\text{AC}}$	2.7 [–]
Electric chiller unit maximum cooling power $Cool_{\text{max}}^{\text{EC}}$	50 [kW h]
Household AC unit maximum cooling power $Cool_{\text{max},i}^{\text{AC}}$	5 [kW h]
Installed wind capacity $X^{\text{wind}}$	50 [kW]
Installed PV capacity $X^{\text{wind}}$	200 [kW]

**Table 3**  
Dependence of the MEM capability to integrate RES on the  $\mu$ CHP technology used.

$\mu$ CHP technology	Efficiency [%]		Optimal PV installed capacity [kW]		Optimal WIND installed capacity [kW]		Total emissions [tons]		Percent of demand met from RES [%]	
	Elec.	Therm.	No bat.	Bat.	No bat.	Bat.	No bat.	Bat.	No bat.	Bat.
Fuel cell	30	55	92	102	71	68	840	834	37.93	38.77
Stirling engine	20	77	70	89	184	180	799	795	61.98	62.24
Comb. engine	26	64	70	81	108	101	817	810	45.78	46.44
Steam engine	24	70	68	79	135	130	808	801	51.81	52.30
$\mu$ gas turbine	24	55	65	88	97	91	863	856	43.21	43.63

the sake of simplicity, the paper does not focus on optimal sizing of the units (which was performed), but rather focuses on providing insight into differences between scheduled and realized operational points and how their plan changes as the time progresses. Furthermore, it captures the impact of efficiency modelling approximations on different operational horizons.

The simulation model was developed using FICO Xpress 7.9 [67] and MATLAB 2015 [68] and run on laptop with Intel i5 @2.3 GHz processor with 8 GB RAM with gap tolerance of 0.05%.

## 5. Annual operation results

### 5.1. Flexibility analysis of different $\mu$ CHP technologies

Developed multi-energy microgrid operation was simulated for 17,520 half-hourly time steps. The available flexibility of the microgrid is measured through waste of energy (heat and curtailed wind expressed in kW h) indicator. In off-grid mode, MEM needs to have enough capacity and flexibility to satisfy the demand in all simulation steps. In on grid mode mismatch in kW h between scheduled (contractual) and realized export/import values of electricity serves as a flexibility indicator.

The initial analyses focus on impact of battery storage and different technologies of distributed generation, characterized by different efficiencies. The results clearly demonstrate specific elements have higher impact in terms of provision of flexibility.

The results from a set of simulations for different  $\mu$ CHP technologies [69] are shown in Table 3. The assumed configuration of MEM is Type 1 (Table 1 – distributed). Total share of  $\mu$ CHP units in households is set to 40%, share of EHP units 30%, while the rest of the households are equipped with boilers as a heating source. Off-grid operation mode was analyzed. It can be seen that the capability of a multi-energy microgrid to integrate RES is highly

dependent on the  $\mu$ CHP unit technology since it represents the most significant heat source in the distributed configuration.

Observing the amount of wasted energy, as an operation efficiency indicator, for all the  $\mu$ CHP technologies, the addition of battery storage in all cases reduces unused energy (Fig. 7). Additionally, it is interesting to observe that technologies with more efficient heat production have higher percentage of curtailed wind. Heat and electricity production are correlated, meaning that in heat following mode excess electricity will be produced by  $\mu$ CHP.

### 5.2. Flexibility aspects of different MEM configurations

Different MEM configurations (Table 1) manifest different operational capabilities (Fig. 8). Highest operational costs are obtained for Type 1 (distributed/household) since smaller units with lower efficiency are used, while the best “performance” is seen for Type 3 and Type 4 where a combination of distributed and centralized units are participating in MEM portfolio.

Since in MEM parallel operation with the system waste of energy is close to zero, more interesting conclusions can be drawn for the off-grid mode. Interestingly, now the lowest waste is achieved for Type 1 configuration. The reason for that is partially that  $\mu$ CHP units do not have ramping or minimum stable operation constraints (as mentioned in previous Section 3.2). However, a general conclusion is that Type 3 (combination of district heating system and household EHP units) has the best trade-off in terms of amount of wasted energy and total costs.

Interesting aspect of annual operational results is seen when adding another energy vector – cooling. The results presented in Fig. 9 show the comparison in energy mix for the case when all cooling demand is met by electrically driven elements (e.g. household AC and EHP) and when separate energy vector of cooling demand is regarded through heat use in absorption chiller. The

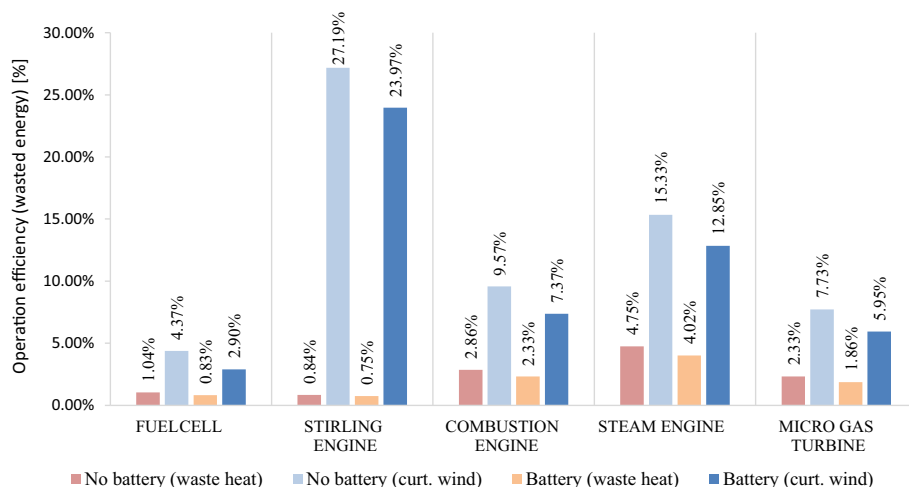

**Fig. 7.** Unused energy for multi-energy microgrid with different  $\mu$ CHP technologies (in percent to total heat used || total wind energy production).

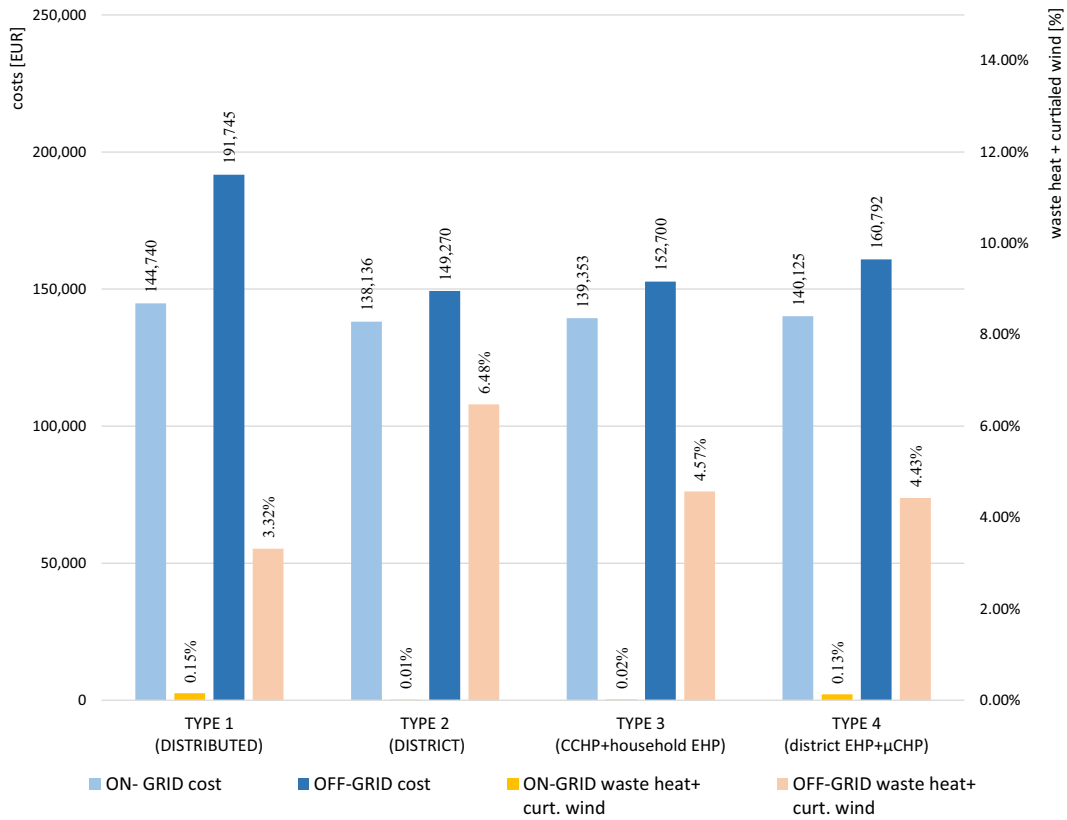

Fig. 8. Operational indicators for different MEM configurations.

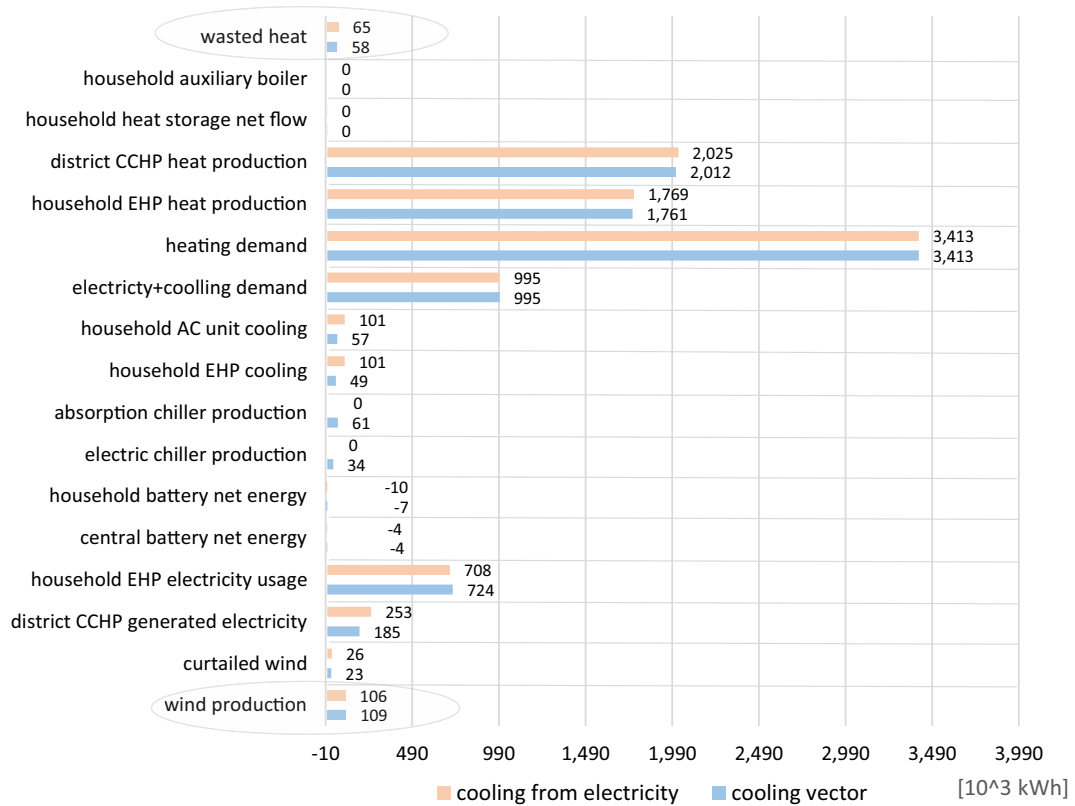

Fig. 9. Comparison of MEM operation for different cooling modes (cooling from electricity VS separate cooling vector).

assumed operation is off-grid. It can be seen that with the separate cooling vector the curtailment of wind is reduced from 24.15% to 20.90% (which equals to 2838 kW h) and waste of heat is reduced from 1.90% to 1.70% (which equals to 6761 kW h). Additionally, operating costs are reduced approximately 21% (from 193,700 EUR to 153,000 EUR), clearly showing flexibility benefits achieved by coupling multiple energy vectors.

Annual operation analyses of MEM with different efficiency modelling approaches (constant value efficiency versus load dependent efficiency) show that the total costs difference for off grid simulation is maximum for Type 3 and is 5.87%. What is more important to observe is the daily behavior of the CCHP operation and the differences that stem from two efficiency modes. The following Section (section VI) explains the main principals of developed RH-MPC corrective control algorithm and shows the importance of deploying such algorithm during the daily operation cycle.

### 6. Daily operational analyses

Daily operational analyses are based on receding horizon with model predictive control (RH-MPC) where MEM is operating parallel to the rest of the power system. In between two successive days MEM is trying to follow the scheduled (contracted) exchanges based on the optimal production plan for 24 h-ahead period. The initial scheduled plan (marked with time step '0') is susceptible to changes due to stochastic element inherent to predictions of demand fluctuations and RES production (included through corresponding probability density functions). In deterministic environment, scheduled and announced operational plan would be fulfilled in every segment. However, realistic, stochastic environment implies that MEM needs to be flexible enough to follow scheduled exchanges with the upstream system, in order to avoid

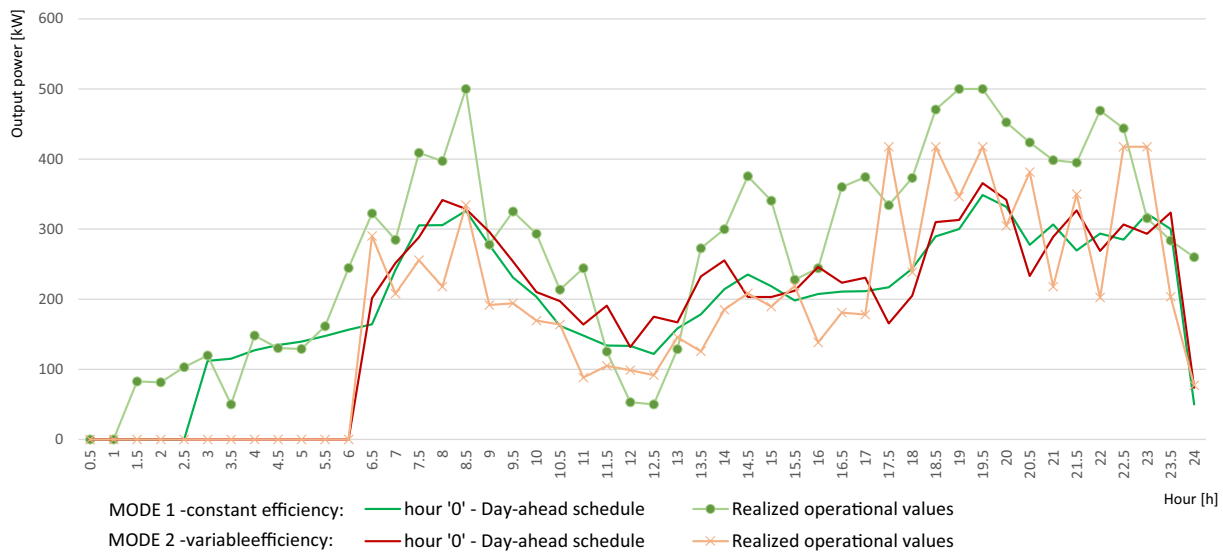

Fig. 10. Scheduled vs. realized values of CCHP plant heat production for a winter day with non-forecasted temperature drop that caused increased heat demand (+10% heating energy used throughout the whole day).

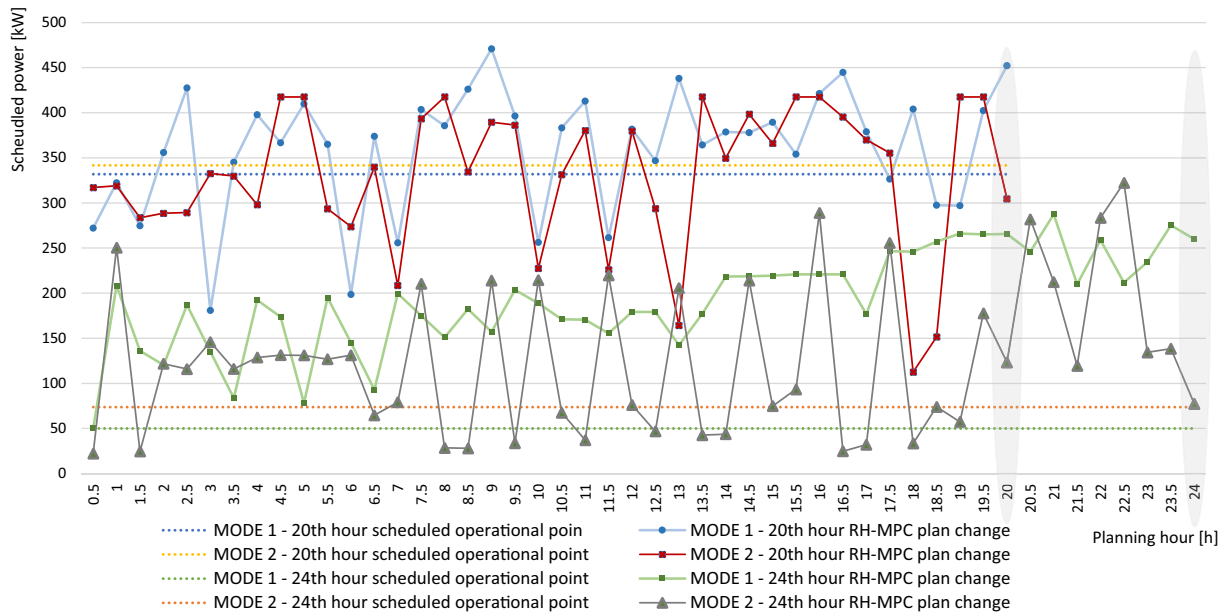

Fig. 11. RH-MPC planned values for last hour of the receding horizon (48th time step) each time step throughout the current day-ahead cycle.



imbalance costs and act in a most beneficial way for the rest of the power system.

Developed corrective control strategy, based on model predictive control, calculates for each time step the optimal MEM operation for the entire look-ahead horizon and applies corrective measures only from current time step till the end of the current planning cycle (24 h cycle of the day-ahead market). The algorithm, as mentioned before, takes into account the intra-day imbalance market [70].

The difference in planned and realized values of operational points of CCHP, also for different efficiency modelling, are depicted in Fig. 10 for a winter day simulation. It shows the difference between constant efficiency and variable efficiency mode. For brevity and easier understanding of figures, modelling efficiencies as approximated constant value is referred to as MODE 1, while load depending value of efficiency is referred to as MODE 2.

Already in the initial day-ahead schedule (hour '0') of CCHP operating points, the differences are noticeable (green and red line on Fig. 10). Although schedules for both modes of efficiencies are of similar shaped, different operating points in early periods of the

day indicate approximations in modelling are highly relevant and can result in incorrect assumptions.

Furthermore, comparing final operational values (resulting from intra-day adjustments by RH-MPC) the difference between electricity exchanged with the upstream system and MEM is noticeable (e.g. during time steps 8–11) suggesting approximations do not provide accurate results relevant to short term operation (green line and orange line with marker on Fig. 10). Fig. 11 shows two different sets of values: first set (dotted lines) shows the planned value for CCHP output made at the start of the day-ahead cycle (again, for efficiency approximation and loading dependent efficiency). Second (line with markers) shows how the planned operational point for a specific hour changes dynamically in each time step. More precisely, planned operational point for a specific hour (e.g. 20th hour) in each planning step is shown on the graph as "RH-MPC plan change". The final operational value (moment when the plan of the last planning horizon is realized) is shaded (Fig. 11). As it can be seen the difference between two efficiency modes is visible both through the rolling of the RH-MPC process and through difference in finally realized output

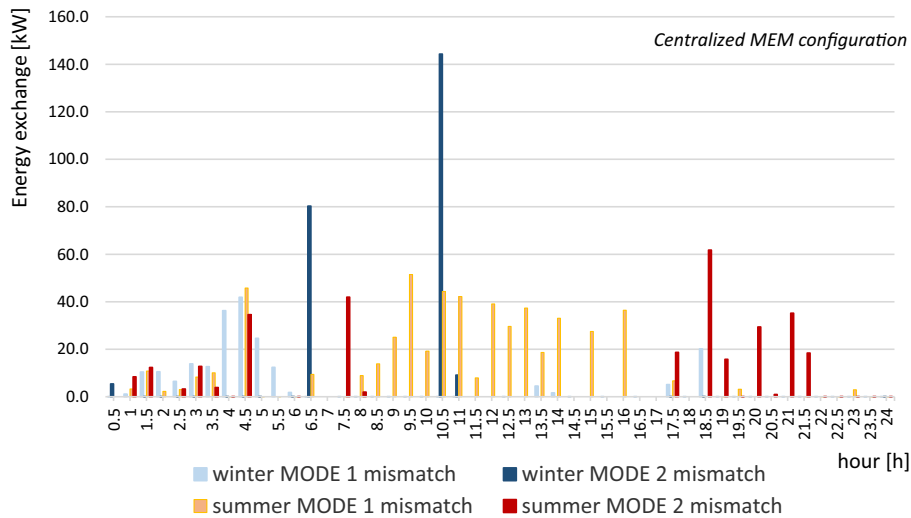

Fig. 12. Mismatch between scheduled (contractual) and realized electricity exchanges for both efficiency modelling approaches in centralized MEM configuration.

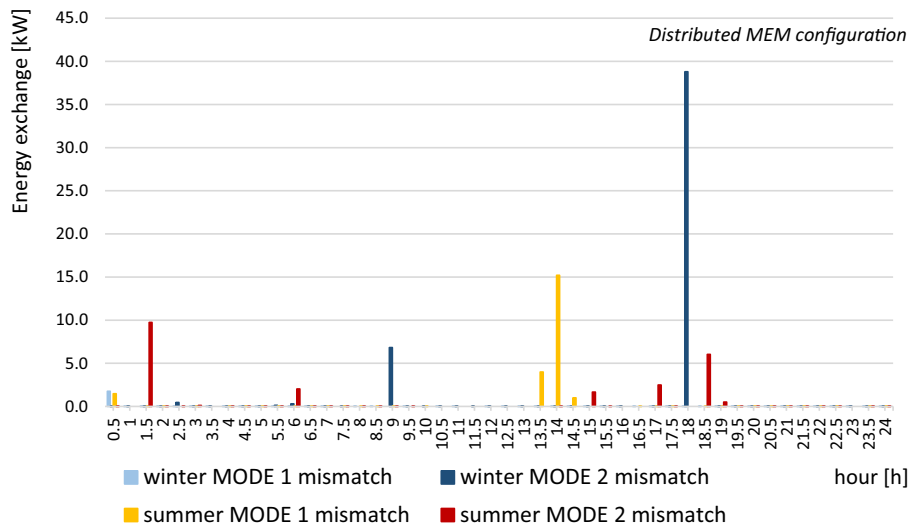

Fig. 13. Mismatch between scheduled (contractual) and realized electricity exchanges for both efficiency modelling approaches in distributed MEM configuration.

power. Mode 2 manifests in steeper changes in plan since the simulation tries to run the production units close to minimum generation or close to highest possible generation in that particular moment.

Flexibility indicator in on-grid operation is represented through a mismatch between the contractual (scheduled) and realized values of import/export electricity. For different MEM configurations, namely distributed and centralized, the mismatch values are shown in Figs. 12 and 13. During summer periods available flexibility is lower due to lower heat demand visible as higher mismatch values. Absolute values of exchange mismatches compared to the total contractual exchange can be noted from Fig. 14.

When comparing the mismatch error for different efficiency modes it can be concluded that on average MODE 1 yields better flexibility indicators (from 10 simulated winter and summer days). Additionally, when observing the precise moment mismatches occur the difference is noticeable. The total exchange volume is on average larger for efficiency MODE 1 (constant efficiency) as can be seen from Fig. 14.

As a final conclusion it should be noted that approximations in modelling lead to over, or under, estimating available flexibility and results in different operating points of MEM units. These errors are highly relevant in on-grid operation as they give incorrect information to the system operator.

### 6.1. Simulation duration

Total duration of the simulation is important when in a daily cycle the optimization at each step (e.g. every 15 or 30 min) needs to be finished. The total duration of the RH-MPC corrective algo-

rithm depends on the efficiency mode used (Table 4). In daily operation simulation each step simulation needs to be finished in approximately 5 s, which sums up to approximately 10 min total if 15-min time steps are used ( $96 \times 5 \text{ s} + \text{data cycling}$ ). For majority of the days the simulation is finished within the given time frame but there are exceptions for the efficiency mode 2 when single step simulation lasts even 30 s (only for a few selected summer days). This means that even though the importance of having more precise efficiency modelling is significant both in terms of cost and operational points in daily operation, using constant efficiency mode approximations guarantees every simulation will be short enough even on an average personal computer. It worth noting that values presented in Table 4 represent maximum duration of a single step and only for the longest possible horizon of the entire day. Average duration is shorter and the whole iterative process at every time step lasts between 200 and 500 s depending on the configuration and simulation setup. In practice, the look-ahead horizon of 8 h (so reducing it to 16 of 32 simulation time steps) might be enough, ensuring satisfactory simulation duration in all possible cases.

### 6.2. Daily operational analyses discussion

To wrap up the results sections the following conclusions can be made regarding the different aspects of conducted simulations:

- (i) Multi-energy microgrid configuration:
  - Microgrids perform differently depending on their configurations and aggregation. The results clearly show that although centralized unit MEM has lower operational

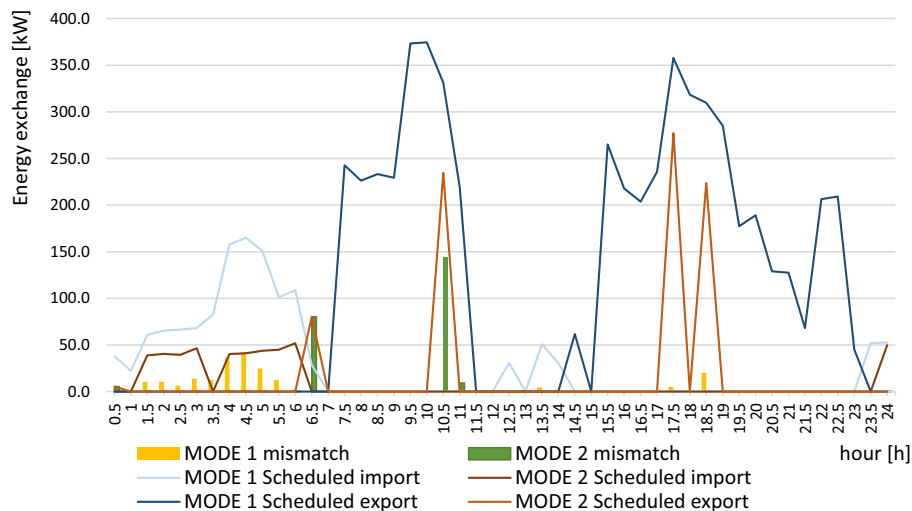

Fig. 14. Contractual exchanges for a winter day simulation for different efficiency modes.

Table 4  
Simulation duration for on-grid mode (30 min time step).

	Total simulation duration [min]		Single iterative step maximum simulation duration [s]		Single iterative step average simulation duration [s]	
	MODE 1	MODE 2	MODE 1	MODE 2	MODE 1	MODE 2
Annual operation – Type 1 (distributed)	141.16	373.50	–	–	–	–
Annual operation – Type 2 (centralized)	130.25	358.78	–	–	–	–
Annual operation – Type 3 (CCHP + household EHP)	129.55	360.12	–	–	–	–
Annual operation – Type 4 (district EHP + $\mu$ CHP)	122.92	300.19	–	–	–	–
RH-MPC daily operation – Type 1 (distributed)	7.68	22.41	4.91	29.42	1.43	4.82
RH-MPC daily operation – Type 2 (centralized)	6.85	19.26	2.84	26.33	0.75	4.22

costs, fully distributed MEM configuration (all household units) is capable of integrating more local RES production.

- Adding energy vectors, such as cooling, to MEM configuration results in higher flexibility manifested as lower operational costs and lower wasted energy.
- (ii) Efficiency mode used:
  - Efficiency of production units, in particular CHP, has large impact on overall MEM operation (shown in Table 3 results).
  - Differences in annual operational costs between constant efficiency mode (mode 1) and variable efficiency depending on the loading (mode 2) are in range of 2–5%. This shows approximations do not have significant effect in long term operational analyses.
  - Difference in daily operational costs between constant efficiency mode (mode 1) and variable efficiency depending on the loading (mode 2) are significant and manifest as different unit operational points as well as larger mismatches for in exchange with the system. This indicates that approximations have high impact on short term schedules.;

## 7. Conclusion and future work

The paper presents a comprehensive multi-energy microgrid model that incorporates flows of different energy vectors: heating, cooling, electricity and fossil fuel. The developed model is linear (MILP) which guarantees optimality of the results. The model is used to track the operation of different MEM configurations through defined flexibility indicators for both off-grid operation (wasted heat and curtailed wind) and on-grid operation (waste of energy and mismatch from contractual electricity import/export). On top of this, impact of efficiency modelling (constant efficiency vs. variable efficiency depending on loading) is analyzed. The results show that there is a significant operational difference both in cost and flexibility indicators when comparing different MEM configurations composed of different production units. Furthermore, efficiency modelling aspect impacts both the process of developed receding horizon corrective control and final operational points of production units. To summarize, following findings can be highlighted:

- (a) Regarding the MEM configuration, combination of centralized and distributed configurations gives the best performance.
- (b) Regarding the coupling of energy vectors, adding additional separate energy vectors (e.g. cooling) increases flexibility by reducing total cost, wasted energy and curtailed RES.
- (c) Regarding the efficiency modelling, total costs on an annual basis are very similar regardless of the efficiency mode used (constant efficiency and variable efficiency).
- (d) Regarding the daily corrective RH-MPC algorithm, on a daily level the results for different efficiency mode are significantly different due to more frequent unit cycling in variable efficiency modelling scenarios.

Further investigation will be headed into the direction of defining flexibility maps for the production units that would in every moment give information how much flexibility, how long and at what cost can be provided. In addition to that, further details regarding the interaction between the energy vectors will be studied as well as the addition of EV vehicles and their inherent stochastic behavior. Furthermore, operational limits of district energy infrastructure will be included in a more detailed fashion. Horizon lengths impact will also be considered to reduce the overall computational time.

## Acknowledgment

The work of the authors is a part of the project IRES-8 Instigation of Research and Innovation Partnership on Renewable Energy, Energy Efficiency and Sustainable, Energy Solutions for Cities funded by European Union and FENISG- Flexible Energy Nodes in Low Carbon Smart Grid funded by Croatian Science Foundation under project grant No. 7766.

## References

- [1] Pollit MG. The future of electricity (and gas) regulation in a low-carbon policy world. *Energy J* 2008;29:63–94.
- [2] Siano P. Assessing the impact of incentive regulation for innovation on RES integration. *IEEE Trans Power Syst* 2014;29:2499–508.
- [3] Baringo L, Conejo AJ. Wind power investment within a market environment. *Appl Energy* 2011;88(9):3239–47.
- [4] Manfren M, Caputo P, Costa G. Paradigm shift in urban energy systems through distributed generation: methods and models. *Appl Energy* 2011;88(4):1032–48.
- [5] Meibom P, Hilger KB, Madsen H, Vinther D. Energy comes together. *IEEE Power Energy Mag* 2013;11(5):46–55.
- [6] Banovac E, Stojkov M, Kozak D. Designing a global energy policy model. *Energy* 2017;170:2–11.
- [7] European Commission. Communication from the Commission: clean energy for all Europeans; 2016.
- [8] Pavić I, Capuder T, Kuzle I. Low carbon technologies as providers of operational flexibility in future power systems. *Appl Energy* 2016;168:724–38.
- [9] Olivares E, Mehrizi-Sani A, Etemadi AH, Canizares CA, Iravani R, Kazerani M, et al. Trends in microgrid control. *IEEE Trans Smart Grid* 2014;5:1905–19.
- [10] Hakimi M, Moghaddas-Tafreshi SM. Optimal planning of a smart microgrid including demand response and intermittent renewable energy resources. *IEEE Trans Smart Grid* 2014;5:2889–900.
- [11] Dietrich K, Latorre JM, Olmos L, Ramos A. Demand response in an isolated system with high wind integration. *IEEE Trans Power Syst* 2012;27:20–9.
- [12] Lannoye E, Flynn D, O'Malley M. Evaluation of power system flexibility. *IEEE Trans Power Syst* 2012;27:922–31.
- [13] Group of authors. Flexibility in 21st Century Power Systems. National Renewable Energy Laboratory; 2014.
- [14] Troy N, Denny E, O'Malley M. Base-load cycling on a system with significant wind penetration. *IEEE Trans Power Syst* 2010;25:1088–97.
- [15] Morvaj B, Evins R, Carmeliet J. Decarbonizing the electricity grid: The impact on urban energy systems, distribution grids and district heating potential. *Appl Energy* 2017;191:125–40.
- [16] Morvaj B, Evins R, Carmeliet J. Optimization framework for distributed energy systems with integrated electrical grid constraints. *Appl Energy* 2016;171:296–313.
- [17] Knezovic K, Martinenas S, Andersen PB, Zecchino A, Marinelli M. Enhancing the role of electric vehicles in the power grid: field validation of multiple ancillary services. *IEEE Trans Transport Electrification* 2016; 99.
- [18] Hatziaargyriou N, Asano H, Iravani R, Marnay C. Microgrids. *IEEE Power Energy Mag*; 2007.
- [19] Pandzic H, Kuzle I, Capuder T. Virtual power plant mid-term dispatch optimization. *Appl Energy* 2011;101:134–41.
- [20] Mashayekh S, Stadler M, Cardoso G, Heleno M. A mixed integer linear programming approach for optimal DER portfolio, sizing, and placement in multi-energy microgrids. *Appl Energy* 2017;187:154–68.
- [21] Hanna R, Ghonima M, Kleissl J, Tynan G, Victor DG. Evaluating business models for microgrids: Interactions of technology and policy. *Energy Policy* 2017;103:47–61.
- [22] Dvorkin Y, Fernandez-Blanco R, Kirschen DS, Pandzic H, Watson J-P, Silva-Monroy CA. Ensuring profitability of energy storage. *IEEE Trans. Power Syst.* 2016; PP(99): p. 1–1.
- [23] Mancarella P. MES (multi-energy systems): an overview of concepts and evaluation models. *Energy* 2014;65:1–17.
- [24] Good N, Karangelos E, Navarro-Espinosa A, Mancarella P. Optimization under uncertainty of thermal storage-based flexible demand response with quantification of residential users' discomfort. *IEEE Trans Smart Grid* 2015;6(5):2333–42.
- [25] Majzooobi A, Khodaei A. Application of microgrids in providing ancillary services to the utility grid. *Energy*; 2017.
- [26] Saint-Pierre A, Mancarella P. Active distribution system management: a dual-horizon scheduling framework for DSO/TSO interface under uncertainty. *IEEE Trans. Smart Grid* 2016; p. 1–12.
- [27] Capuder T, Mancarella P. Assessing the benefits of coordinated operation of aggregated distributed multi-energy generation. In: Power system computation conference (PSCC) 2016; 2016. p. 1–7.
- [28] Cui H, Li F, Hu Qinran, Bai L, Fang X. Day-ahead coordinated operation of utility-scale electricity and natural gas networks considering demand response based virtual power plants. *Appl Energy* 2016;176:183–95.
- [29] Ghahgharaee Zamani A, Zakariazadeh A, Jadid S. Day-ahead resource scheduling of a renewable energy based virtual power plant. *Appl Energy* 2016;169:324–40.

- [30] Rahimiyan M, Baringo L. Strategic bidding for a virtual power plant in the day-ahead and real-time markets: a price-taker robust optimization approach. *IEEE Trans Power Syst* 2016;31(4):2676–87.
- [31] Zhang N, Kang C, Xia Q, Huang Y. A convex model of risk-based unit commitment for day-ahead market clearing considering wind power uncertainty. *IEEE Trans Power Syst* 2014; 30(3): p. 1582–1592.
- [32] Baringo A, Baringo L. A stochastic adaptive robust optimization approach for the offering strategy of a virtual power plant. *IEEE Trans Power Syst* 2016; 8950(c): p. 1–1.
- [33] Chicco G, Mancarella P. Matrix modelling of small-scale trigeneration systems and application to operational optimization. *Energy Mar.* 2009;34(3):261–73.
- [34] Capuder T, Mancarella P. Techno-economic and environmental modelling and optimization of flexible distributed multi-generation options. *Energy* 2014.
- [35] Wang H, Mancarella P. Towards sustainable urban energy systems: high resolution modelling of electricity and heat demand profiles. In: *Powercon*, 2016, pp. 1–6
- [36] Holjevac N, Capuder T, Kuzle I. Adaptive control for evaluation of flexibility benefits in microgrid system. *Energy* 2015;52:487–504.
- [37] Mancarella P, Chicco G. Demand response from energy shifting in distributed multi-generation. *IEEE Trans Smart Grid* 2013;4(4):1928–38.
- [38] Holjevac N, Capuder T, Kuzle I. Defining key parameters of economic and environmentally efficient residential microgrid operation. *Energy Procedia* 2017;105C:999–1008.
- [39] Schütz T, Harb H, Streblov R, Müller D. Comparison of models for thermal energy storage units and heat pumps in mixed integer linear programming. In: *The 28th international conference on Efficiency, Cost, Optimization, Simulation and Environmental Impact of Energy Systems, ECOS 2015*, Pau, France; 2015.
- [40] Zhang L, Capuder T, Mancarella P. Unified unit commitment formulation and fast multi-service LP model for flexibility evaluation in sustainable power systems. *IEEE Trans Sustain Energy* 2016;7(2):658–71.
- [41] Henwood MI, van Ooijen M. An algorithm for combined heat and power economic dispatch. *IEEE Trans Power Syst* 1996;11:1778–84.
- [42] Verda V, Colella F. Primary energy savings through thermal storage in district heating networks. *Energy* 2011;36:4278–86.
- [43] Papaefthymiou G, Hasche B, Nabe C. Potential of heat pumps for demand side management and wind power integration in the German electricity market. *IEEE Trans Sustain Energy* 2012;3:636–42.
- [44] Capstone C1000 Series Microturbine System Technical Reference. Capstone Turbine Corporation, Chatsworth, CA, USA, Tech. Rep. 410066, Rev B; 2011.
- [45] Fang F, Wang Q, Shi Y. A novel optimal operational strategy for the CCHP system based on two operating modes. *IEEE Trans Power Syst* May 2012;27(2):1032–41.
- [46] Capstone C30 Microturbine Technical Reference. Capstone Turbine Corporation, Chatsworth, CA, USA, Tech. Rep. 410066, Rev H; 2006.
- [47] Capstone C200 Microturbine Technical Reference. Capstone Turbine Corporation, Chatsworth, CA, USA, Tech. Rep. 410066, Rev C; 2009.
- [48] Krishna CR. Performance of the Capstone C30 Microturbine on Biodiesel Blends. Upton NY, USA: Brookhaven National Laboratory; 2007.
- [49] Xiao X, Zheng G, Kan W, Chen X, Wang B, Wang T. Study on the structure and control system of Capstone C200 Microturbine. *Gas Turbine Technol* Dec 2010;23(4):18–21.
- [50] Acadia Heat Pump Technical Brouchure, Hollowell International, EnergyIdeas Claringhouse, PTR #19; December 2007.
- [51] Data Sheet LA 12TU heat pump. Glen Dimplex Germany; November 2016.
- [52] Nagota T, Shimoda Y, Mizuno M. Verification of the energy-saving effect of the district heating and cooling system—Simulation of an electric-driven heat pump system. *Energy Build* 2008;40:732–41.
- [53] Chua KJ, Chou SK, Yang WM. Advances in heat pump systems: A review. *Appl Energy* 2010;87:3611–24.
- [54] Good N, Navarro-Espinosa A, Karangelos E, Mancarella P. Participation of electric heat pump resources in electricity markets under uncertainty. In: *Proceedings of 10th Int. Conference on the European Energy Market*; 2013.
- [55] Almalkhi MR, Towle A. Enabling city-scale multi-energy optimal dispatch with energy hubs. *Power Systems Computation Conference (PSCC)*; 2016.
- [56] Labidi M, Eynard J, Faugeroux O, Grieu S. A new strategy based on power demand forecasting to the management of multi-energy district boilers equipped with hot water tanks. *Appl Therm Eng* 2017;113:1366–80.
- [57] Dincer I. Thermal energy storage systems as a key technology in energy conservation. *Int J Energy Res* 2002;26:567–88.
- [58] Chen X, Kang C, O'Malley M, Xia Q. Increasing the flexibility of combined heat and power for wind power integration in China: modeling and implications. *IEEE Trans Power Syst* 2015;30(4):1848–57.
- [59] Li G, Zhang R, Jiang T, Chen H, Bai L, Cui H, Li X. Optimal dispatch strategy for integrated energy systems with CCHP and wind power. *Appl Energy* 2017;192:408–19.
- [60] Demand profile generators. University of Strathclyde; December 2016. online: <http://www.strath.ac.uk>.
- [61] Capuder T, Mancarella P. Techno-economic and environmental modelling and optimization of flexible distributed multi-generation options. *Energy* 2014;71:516–33.
- [62] Guerrero JC, Vasquez J, Vicuña LG, Castilla M. Hierarchical control of droop-controlled AC and DC microgrids—a general approach toward standardization. *IEEE Trans Ind Electron* 2011;58:158–72.
- [63] Ambrosio R, Widergren SE. A framework for addressing interoperability issues. *IEEE PES General Meeting*; 2007. p. 1–5.
- [64] Marinelli M, Sossan F, Costanzo GT, Bindner H. Testing of a predictive control strategy for balancing renewable sources in a microgrid. *IEEE Trans Sustain Energy* 2014;5:1426–33.
- [65] Larsen G, van Foreest N, Scherpen J. Distributed MPC applied to a network of households with micro-CHP and heat storage. *IEEE Trans Smart Grid* 2014;5:2106–14.
- [66] Parisio A, Rikos E, Tzamalīs G, Glielmo L-. Use of model predictive control for experimental microgrid optimization. *Appl Energy* 2014;1(15):37–46.
- [67] FICO Xpress, online Dec. 2016: [www.fico.com](http://www.fico.com)
- [68] MathWorks MATLAB, online Dec. 2016: [www.mathworks.com](http://www.mathworks.com)
- [69] Jablko R, Saniter C, Hantisch R, Holler S. Technical and economical comparison of micro CHP systems. In: *2005 International Conference on Future Power Systems*. Amsterdam, Netherlands; 2005. p. 1–6.
- [70] Elexon Imbalance Pricing Guidance – A guide to electricity imbalance pricing in Great Britain, version 11.0, Oct. 2016.

**Publication 2 - Adaptive Control for Evaluation of Flexibility Benefits in  
Microgrid Systems**

Holjevac, Ninoslav; Capuder, Tomislav; Kuzle, Igor. “Adaptive Control for Evaluation of Flexibility Benefits in Microgrid Systems”, *Energy*, vol. 92, Part 3, 2015, pp. 487-504

DOI: 10.1016/j.energy.2015.04.031

- *18 pages*



# Adaptive control for evaluation of flexibility benefits in microgrid systems



Ninoslav Holjevac<sup>\*</sup>, Tomislav Capuder, Igor Kuzle

University of Zagreb Faculty of Electrical Engineering and Computing, Croatia

## ARTICLE INFO

### Article history:

Received 8 November 2014

Received in revised form

5 March 2015

Accepted 9 April 2015

Available online 27 May 2015

### Keywords:

Microgrid flexibility

MILP (Mixed Integer Linear Programming)

MPC (Model Predictive Control)

RES (renewable energy sources)

Uncertainty

## ABSTRACT

Aggregating groups of loads and generators at the same location with centralized control is known as the concept of microgrids. However, if those flexible producers and consumers do not have the ability to balance the variability and uncertainty of RES (renewable energy sources) production within them, from the system perspective they are seen as a source of imbalances and potential problems in maintaining the equilibrium of production and consumption. The paper's main goal is to quantify the ability of microgrid components to provide flexibility. This flexibility is analysed from two perspectives, defining two operating principles of each microgrid: independently from the distribution grid and connected, interacting and responding to signals from the upstream system. Following on this, the paper presents two relevant cases.

In the first part a deterministic model is developed based on MILP (Mixed Integer Linear programming) simulating the microgrid operation over one year period. This model is used to determine the optimal microgrid configuration with respect to the amount of unused energy, thus defining role and capability of different pieces of equipment and their size (RES (renewable energy sources) wind and solar, HS (heat storage),  $\mu$ CHP (micro combined heat and power plants) and EHP (electric heat pumps)).

The second part of this paper further expands the model with MPC (Model Predictive Control) approach in order to capture the behaviour of microgrid interaction with the distribution grid, modelling uncertainties of forecasting RES production by stochastic programming. The model is capable to evaluate both the impact of variable energy production and consumption and the impact of energy balancing tariffs depending on the amount of balancing energy needed for the microgrid operation.

© 2015 Elsevier Ltd. All rights reserved.

## 1. Introduction

Integration of RES (renewable energy sources) is largely driven by governmental incentives, especially for RES on a small domestic scale. As the share of RES increases, the concept of incentives becomes unsustainable and the need to develop new approaches becomes inevitable. Traditionally, any generation mismatch caused by variations in RES generation had to be compensated by other generating units. Today the development is shifting towards enabling the flexibility from the consumer, ranging from flexible demand to distributed generation. Controllable and RES technologies at the low voltage level cover a wide range of units: PV (photo-voltaic units), WPP (wind power plants), EHP (electric heat pumps),  $\mu$ CHP (micro combined heat and power units), HS (thermal energy

storage), BS (battery storage) etc. Aggregating these technologies creates a market entity capable of not only isolated operation but also interaction with the electric system [1]. Distributed systems, such as the ones mentioned above, need to be integrated with the rest of power grid's control system by means of aggregation and market mechanism. Although ideas of virtual power plants and standalone microgrids are not new [2], there is still a lack of models capable of representing the behaviour and scheduling such clusters of units. A good model must provide robust response of microgrid to fluctuations of connected RES and, if needed, has to ensure stand-alone operation with minimum to no interaction with the rest of the electrical grid.

The ideas presented in this paper can be regarded as an extension of the multi-energy concept [3]. Flexibility from the multi-energy systems can be utilized from the capability of complementary technologies, such as CHP and EHP, to shift between different energy vectors, e.g. gas and electricity, and produce the desired output at minimum cost [4]. Benefits of these flexibility

<sup>\*</sup> Corresponding author.

E-mail address: [ninoslav.holjevac@fer.hr](mailto:ninoslav.holjevac@fer.hr) (N. Holjevac).

capabilities are elaborated for the concept of demand response [5] also emphasizing the potential of this systems to provide additional flexibility services [6].

The methodology for decision-making on local microgrid level is not simple and has many key factors that have to be included as is stated by Kopanos et al. in Ref. [7]. Microgrid comprises of both dispatchable units (e.g. distributed generators) needed to balance the microgrid and uncontrollable units such as RES whose production cannot be precisely estimated. Additionally, FL (flexible loads), EES (energy storage systems) and connection to the rest of the system have to be modelled in order to find optimal control approach. There are several methods found in the literature that tackle the problem of finding the best control algorithm. In Ref. [8] Sanseverino et al. search for a solution of optimal operation of a microgrid is done using a non-dominated sorting algorithm that includes forecast error. Different approach using Mixed Integer Linear Programming (MILP) for a mid-term virtual power plant dispatch optimization was investigated in Refs. [9] and [10] by Pandžić et al. where uncertainty of the wind and solar power generation is settled using storage in order to provide flexible operation. Furthermore, complex and computationally demanding approaches such as multiagent modelling presented by Wang et al. in Ref. [11], evolutionary strategies presented by Basu in Ref. [12] and particle swarm optimization [13] do not guarantee global optimality of the solution. Different researches include different microgrid components with different levels of details when modelling the operation. Gas engines and heat storage units are analysed thoroughly while rest of the technologies are not included in work done by Fragaki et al. in Ref. [14]. Flexibility of coupled operation of different microgrid configurations consisting of different elements was considered by Capuder and Mancarella in Ref. [15] demonstrating benefits of coupling EHP, CHP and HS to reduce both the operational cost and environmental impact. Research by Mehleri *et al.* presented in Ref. [16] and by Kopanos et al. in Ref. [7] elaborates on optimal design of distributed system, however does not capture variability and uncertainty of RES operation in such systems. Geographic evaluation in selection of electricity production mix is presented in Ref. [17]. Work done by Moradi et al. [18] optimizes the capacity of distributed sources and develops an operational strategy but uses heuristic methods and does not consider stochastic element. On the other hand bi-level optimization model proposed by Wang et al. in Ref. [19] deals with the uncertainties of the microgrid operation but the elements are not optimally sized. In Ref. [20] the requirement for the microgrid to operate totally independent is relaxed when uncertainty is introduced. Additionally, only the interconnection between heat storage and heat pumps is investigated by Arteconi et al. in Ref. [21].

MILP approach coupled with MPC (Model Predictive Control) has the potential to be efficient tool since it is based on future predictions as well as the present state of the system. This combination provides a good mechanism to deal with uncertainty of predictions implemented as central controller [22] or as distributed control [23]. Optimization of battery storage operation is presented in Ref. [24] by Malysz et al. where battery is used to maximize economic benefits for both the customers and utility operators. Perkovic et al. [25] used receding horizon model predictive control for smart management of residential type microgrid while taking into account PEV (Plug-in Electric Vehicles) as energy storage with the goal of maximizing profit. The concept of electric vehicles as flexible load in unit commitment problem is presented by Madzharov et al. in Ref. [26] and Wencong et al. in Refs. [27] and [28] applying MPC strategy. Detailed methodology for the integration of different charging schemes for electric vehicles is presented by Kiviluoma and Meibom in Ref. [29]. Energy management system

using rolling horizon strategy for an isolated renewable-based microgrid is presented by Marietta et al. in Ref. [30]. Another MPC control algorithm which minimizes the daily operation cost, tested on a real microgrid that proves the feasibility of proposed approach was described by Parisio et al. in Ref. [31]. The use of day ahead planning horizon of 24 h in MPC algorithm is considered in Ref. [32] by Molderink et al. While majority of optimization algorithms set minimization of operational costs or maximization of profit as objective functions, Ren et al. in Ref. [33] propose an algorithm that minimizes emissions and emissions cost, trying to reduce environmental impacts of energy production. Multi-objective optimization genetic algorithms are the most commonly used technique attempting to capture both, for example, economic benefits and emission reductions, as in example by Deng et al. [34], but the final result is not guaranteed to be the global optimum as it is the case with MILP models. An example of a comprehensive tool for efficient design and operation of microgrids is given by Piacentino et al. in Ref. [35].

Following on the research review above, it is important to notice that there are currently no integrated models including all the important elements (PEV, FL, battery and heat storage,  $\mu$ CHP etc.) and providing a comprehensive study of operational costs, energy usage, energy curtailment, losses, equipment degradation information, environmental study, uncertainty impact and optimal sizing problem.

The focus of this paper is thus on defining the flexibility that can be gained by optimally coupling heat storage,  $\mu$ CHP, EHP and flexible demand in microgrid operation while at the same time enabling the full integration of RES. Both the optimal selection of microgrid elements and operation planning in stochastic environment are considered on one conclusive microgrid model.

The paper is organized as follows: In Section 2 main contributions of the developed approach are described, followed by detailed model description in Section 3. In Section 4 results of the deterministic analysis are presented and in Section 5 results of simulations in stochastic environment. Section 6 presents results of performed sensitivity analysis done in the stochastic environment. Finally conclusions are drawn and future plans presented.

## 2. Main contributions

The first contribution of the paper is defining the value of different flexible components, such as EHP,  $\mu$ CHP and FL (Flexible Load), on microgrids ability to operate in the off grid mode. A mathematical model based on MILP (Mixed Integer Linear Programming) is developed to simulate the off grid operation over one year period including emissions costs, determining the optimal parameters with respect to the amount of unused energy on microgrid level. This series of simulations was done with deterministic input data. A comparison of deterministic model simulation off-grid and on-grid is also conducted. Determined optimal sizes of installed wind aggregates and PV units for given microgrid configuration are afterwards used to study how much flexibility can be gained by altering heat storage capacity, flexible demand percentage and percentage of specific controllable DG unit installed with consumers. The flexibility for an off-grid mode is evaluated as the yearly amount of unused energy; curtailed RES electricity and wasted heat. The waste of energy happens when there is not enough flexibility in the microgrid to accept all RES production or when the dispatchable unit have to work in an operational point in which they produce excess of heat or electricity.

The second contribution of the paper is the rolling unit commitment model incorporating MPC algorithm optimizing the microgrid operation on a daily basis considering the uncertainties inherent to the RES production and demand forecasting. Adding

MPC improves the system’s ability to react to prediction errors [36,37] and that approach was modified and augmented. The developed controller takes into account a series of future moments instead of making decision just based on current status of the system. It minimizes day ahead scheduling error of the microgrid as well as the operational cost based on penalizing export/import balancing energy cost, emissions cost and total fuel cost.

It should be noted that, through a number of analyses, the paper clearly recognizes benefits (costs and emissions reduction and flexibility increase) of coupling and coordinated operation of  $\mu$ CHP and EHP units. The operation is supported by HS as heat buffer, in order to compensate for the fluctuating nature of RES production and to minimize, or if possible totally exclude, balancing interaction with distribution network. HS also has a vital role in decoupling process of electricity and heat that increases the flexibility of microgrid operation with the emulation of virtual electricity storage [38]. This way microgrid can operate as independent entity at any time needed, follow the scheduled import/export plan and compensate for unpredictable fluctuations in RES production with developed MPC strategy.

### 3. Microgrid system components and modelling

The modelled microgrid consists of 300 households, each modelled by a specific heat and electricity demand profile, multiple DG (distributed generation) units ( $\mu$ CHP, EHP, boiler), heat storage, and household installed RES units, in particular solar panels and small wind aggregates as is shown on Fig. 1.

In all the simulations following assumptions were made:

- microgrid optimization and operation is primarily market driven and voltage and frequency stability are assumed to be controlled on the lower level and are not considered;
- microgrid consists of the following elements: PV arrays, wind turbines,  $\mu$ CHP units, EHP units, flexible and inflexible loads,

heat storage, and boiler units. The concept relies only on units widely adopted by the consumers and thus for now does not include BS or PEV. It should be noted that the model can easily be expanded to include additional technologies;

- central controller is assumed to have all the required information about the present state of the microgrid (boiler, EHP and  $\mu$ CHP operational points, house heat storage unit capacity, market energy prices, RES production);
- energy exchanged with the grid is assumed to be bought/sold at day-ahead market and market imbalance prices (SSP (system sell price) and SBP (system buy price) are used in stochastic modelling [39]);
- microgrid is small enough to act as a price taker and does not influence the formation of prices on the market;
- connection with the distribution grid is unconstrained;
- flexible consumers are not compensated for rescheduling their output;
- sampling time is constant ( $\Delta T \cdot \tau = t_k - t_{k-1}$ ) and the ration between power and energy is therefore also constant. The time step used is half an hour. Table 1 gives a description of the parameters. The factor  $\tau$  was used to enable a simple change of time step. If the default period  $\Delta T$  is one hour long, factor  $\frac{1}{2}$  gives half an hour long time steps. Values of parameters are often expressed as energy in kWh and therefore it is important to have a constant time step so the power values could be obtained. For example in certain time step boiler production was 5 kWh which equals to power output of 10 kW through one time step of half an hour.

Basic concept of the described microgrid is shown in Fig. 1. The blue arrows represent the flow of electrical energy, red arrows fuel (natural gas) flow and yellow arrows heat flow. The single busbar to which all elements are connected is presented as thick black line. As it can be seen the microgrid consists of heat and electricity consumers (households with their heat and electricity demands),

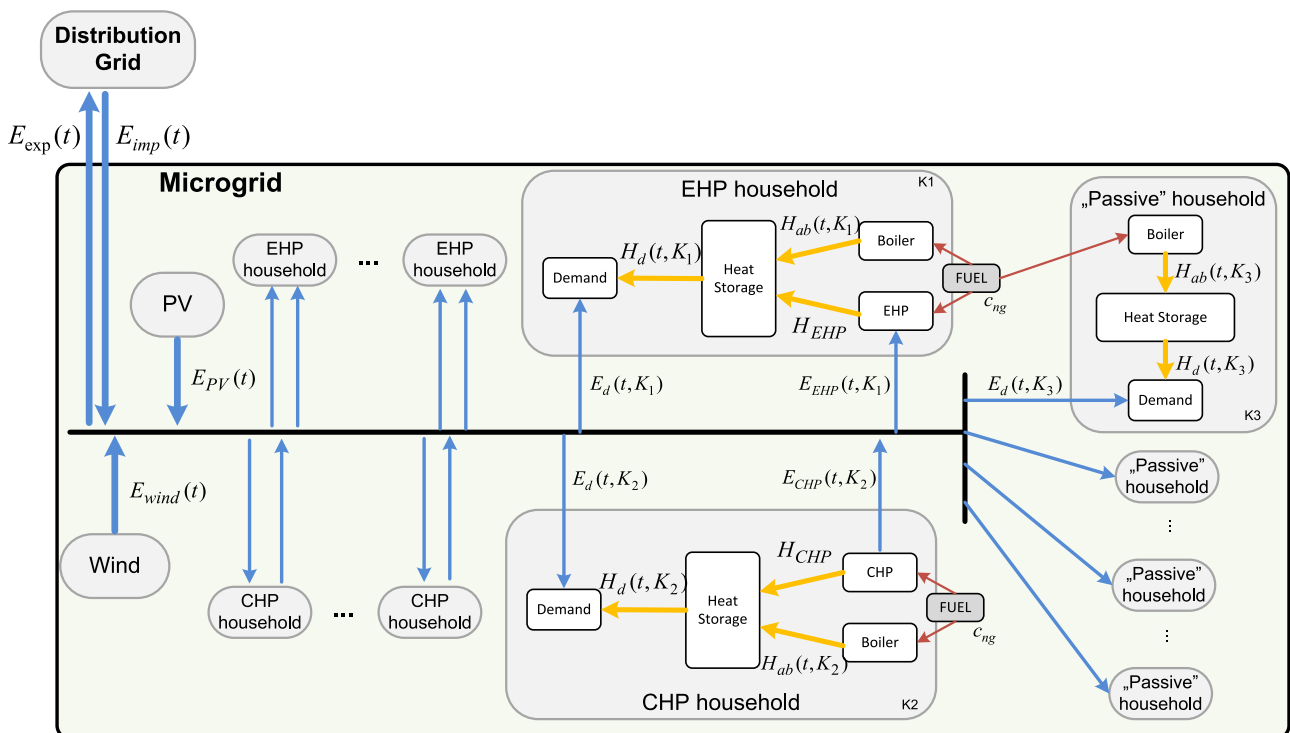

Fig. 1. Schematic of a modelled microgrid.



**Table 1**  
Parameters of the optimization model.

Parameter	Description
$K$	Total number of households
$i$	Counter referring to $i$ -th household
$t$	Current simulation step
$T_{max}$	Time horizon of the simulation [hour]
$\tau$	Simulation time step duration (share of an a default hour long period $\Delta T$ )
$c_{ng}(t)$	Natural gas supply price [€/kWh]
$P$	Penalty factor for waste heat and wind energy [€/kWh]
$M_1$	Factor that modifies MCP to obtain SSP (system sell price)
$M_2$	Factor that modifies MCP to obtain SBP (system buy price)
$H_{chp\_max}(t,i)$	Maximum heat production of $\mu$ CHP unit [kWh]
$H_{chp\_min}(t,i)$	Minimum heat production of $\mu$ CHP unit [kWh]
$\eta_{chp\_e}(t,i)$	Electric efficiency of $\mu$ CHP unit
$\eta_{chp\_t}(t,i)$	Thermal efficiency of $\mu$ CHP unit
$H_{ehp\_max}(t,i)$	Maximum heat production of EHP unit [kWh]
$COP(t,i)$	Coefficient of performance of EHP unit
$H_{ab\_max}(t,i)$	Maximum thermal output of a boiler unit [kWh]
$\eta_{ab}(t,i)$	Boiler efficiency
$H_{hs\_max}(t,i)$	Maximum heat storage energy content [kWh]
$\eta_{hs}(t,i)$	Heat storage efficiency
$p_{flex}$	Percentage of total electrical load defined as flexible
$C_{flex\_max}(t)$	Maximum capacity of flexible load being rescheduled [kWh]

electricity producers ( $\mu$ CHP), heat producers (EHP,  $\mu$ CHP and auxiliary boilers) and buffers enabling decoupling of heat and electricity demand – HS (heat storages). The possibility of direct electrical energy storage is not modelled, even though the heat storage in combination with  $\mu$ CHP and EHP units can provide a certain ability to change the electrical power output [4,40].

This paper presents the continuation of work presented in Ref. [41]. In this paper control-oriented approach for microgrid operation is developed. In order to include both the design and operation segments of microgrid planning process a MILP based model is developed capable of two-fold microgrid analysis:

- deterministic model capable for the entire year optimal operation focussing on optimal sizing of microgrid units and capturing operation and short-term planning interaction for microgrid level;
- rolling unit commitment model incorporating MPC to investigate the possibility of a microgrid to operate independently in stochastic environment.

As stated, these models are used to simulate microgrid operation for a desired period in both deterministic and stochastic environment. The model is expanded with environmental study and more detailed model of pricing mechanism that includes imbalance prices. Furthermore, the stochastic component is added with more details enabling sensitivity analysis capturing different levels of error. All microgrid components are modelled using CPLEX solver FICO Xpress [42]. Data manipulation, stochastic environment introduction and results extraction was done using MATLAB 2013 [43].

In Tables 1–3 a lists of indices, input and decision variables are given for easier understanding of the mathematical formulation parameters used in optimization problem formulation.

### 3.1. $\mu$ CHP (micro combined heat and power unit)

A number of households with larger heat consumption use  $\mu$ CHP units as main heat source.  $\mu$ CHP units are modelled with peak power of 8 kW<sub>t</sub> and technical minimum of 1,6 kW<sub>t</sub>. The coefficient  $\tau$  is used since technical min/max constraints are expressed in kWh values. This way the model is able to capture different time step resolutions which usually depend on the market structure and settlement periods in the observed market. In all simulations in this paper a 1/2 h time step is considered.

$$H_{chp\_min}(i) \cdot \tau \leq H_{chp}(t, i) \leq H_{chp\_max}(i) \cdot \tau \quad (1)$$

It is assumed that  $\mu$ CHP units can adjust their output fast enough and no ramp constraints have been introduced. Production of electrical energy of  $i$ -th  $\mu$ CHP unit in every time step:

$$E_{chp}(t, i) = H_{chp}(t, i) \cdot \frac{\eta_{chp\_e}(t, i)}{\eta_{chp\_t}(t, i)} \quad (2)$$

Fuel consumption of all CHP units is:

$$fuel_{chp\_total}(t) \leq \sum_i^K \frac{H_{chp}(t, i)}{\eta_{chp\_t}(t, i)} \quad (3)$$

**Table 2**  
Forecasts (inputs of the optimization algorithm).

Parameter	Description
$H_d(t,i)$	Heat demand of $i$ -th household [kWh <sub>t</sub> ]
$E_d(t,i)$	Electricity demand of $i$ -th household [kWh <sub>e</sub> ]
$H_{wind}(t)$	Scaled to 1 kWh of installed power hourly wind production [kWh]
$E_{pv}(t)$	Scaled to 1 kWh of installed power hourly PV production [kWh]
$c_{imp}(t)$	Import electricity price [€/kWh]
$c_{exp}(t)$	Export electricity price [€/kWh]

**Table 3**  
Decision variables of the optimization model.

Parameter	Description
$H_{chp}(t,i)$	Heat production of $\mu$ CHP unit [kWh]
$H_{hs}(t,i)$	Heat flow through heat storage [kWh]
$C_{hs}(t,i)$	Heat storage energy content at simulation step t [kWh]
$H_{ab}(t,i)$	Heat production of a boiler unit [kWh]
$E_{flex}(t,i)$	Flexible loads being rescheduled [kWh]
$E_{wind\_real}(t)$	Available wind energy [kWh]
$E_{wind\_gen}(t)$	Used wind energy [kWh]
$E_{wind\_curt}(t)$	Curtailed wind energy [kWh]
$E_{pv\_real}(t)$	Available solar energy [kWh]
$H_{waste}(t)$	Wasted heat [kWh]
$C_{flex}(t)$	Capacity of flexible load being rescheduled at simulation step t [kWh]
$X_{wind}$	Installed wind power [kW]
$X_{pv}$	Installed PV power [kW]
$E_{imp}(t)$	Imported energy from the grid [kWh]
$E_{exp}(t)$	Exported energy to the grid [kWh]
$fuel_{ab\_total}(t)$	Total fuel energy used in auxiliary boiler [kWh]
$fuel_{chp\_total}(t)$	Total fuel energy used in CHP units boiler [kWh]
$F(t)$	Total fuel energy used [kWh]
$short_{imp}(t)$	Negative mismatch in import
$short_{exp}(t)$	Negative mismatch in export
$long_{imp}(t)$	Positive mismatch in import
$long_{exp}(t)$	Positive mismatch in export

### 3.2. EHP (electric heat pump unit)

A number of households have EHP as main heat source. EHP is modelled with its peak heat power of 10 kW<sub>t</sub> and coefficient of performance COP (coefficient of performance) which varies throughout the year. COP values are shown in Table 4. Assumed EHP type is air–water and is therefore dependent on the outdoor temperature and temperature difference. Households that have no EHP have the  $H_{ehp}(t,i)$  equal to 0.

$$H_{ehp}(t,i) \leq H_{ehp\_max}(t,i) \cdot \tau \quad (4)$$

Heat production of EHP unit in every time step and household is:

$$E_{ehp}(t,i) = \frac{H_{ehp}(t,i)}{COP(t)} \quad (5)$$

### 3.3. AB (Auxiliary boiler ) and HS (heat storage)

All households are equipped with gas boiler which is being used when heat demand is too large to be covered by primary heat sources (EHP or  $\mu$ CHP) or when optimization algorithm dispatches it under right circumstances. Passive households have only boiler available as a heat source. Boiler has peak power of 10 kW<sub>t</sub> and efficiency of fuel conversion is 85%:

$$H_{ab}(t,i) \leq H_{ab\_max}(t,i) \cdot \tau \quad (6)$$

$$fuel_{ab\_total}(t) \leq \sum_i^K \frac{H_{ab}(t,i)}{\eta_{ab}(t,i)} \quad (7)$$

Additionally, all households have a simple water tank, or heat storage with the energy capacity  $C_{hs\_max}$  of 6 kWh. To store that amount of heat, assuming water temperature difference of

**Table 4**  
Simulation parameters initial values.

Parameter	Unit	Value
Simulation time $T_{max}$	[hour]	8760
Simulation time step duration $\tau$	[hour]	0.5
Number of households $K$	–	300
Penalty factor for unused energy $P$	[€/kWh]	300
Natural gas price $c_{ng}$	[€/kWh]	0.025
Household heat storage energy content $C_{hs\_max}$	[kWh <sub>t</sub> ]	6
Flexible load share $p_{flex}$	[%]	15
Maximum flex load capacity $C_{flex\_max}$	[kWh]	50
Electric efficiency of $\mu$ CHP unit $\eta_{chp\_e}$ <sup>a</sup>	–	0.38
Thermal efficiency of $\mu$ CHP unit $\eta_{chp\_t}$ <sup>a</sup>	–	0.55
Maximum thermal output of CHP unit $H_{chp\_max}$	[kWh <sub>t</sub> ]	8
Maximum thermal output of EHP unit $H_{ehp\_max}$	[kWh <sub>t</sub> ]	10
Share of households with CHP based heating	[%]	45
Share of households with EHP based heating	[%]	45
Share of households with only boiler based heating	[%]	10
Coefficient of performance of EHP unit $COP(t)$	–	3.5/3.0/2.5 summer/inter/winter
Maximum thermal output of a boiler unit $H_{ab\_max}$	[kWh <sub>t</sub> ]	10
Boiler efficiency $\eta_{ab}$	–	0.85
Maximum heat storage energy content $C_{hs\_max}$	[kWh <sub>t</sub> ]	6
Heat storage efficiency $\eta_{hs}$	–	0.98
Heat storage discharge/charge rate per time step $E_{hs\_max}$	[kWh <sub>t</sub> ]	$C_{hs\_max} \cdot \tau$

<sup>a</sup>  $\mu$ CHP efficiencies can vary depending on the technology and most commercially available technologies have heat to electricity efficiency ratio closer to 2:1.

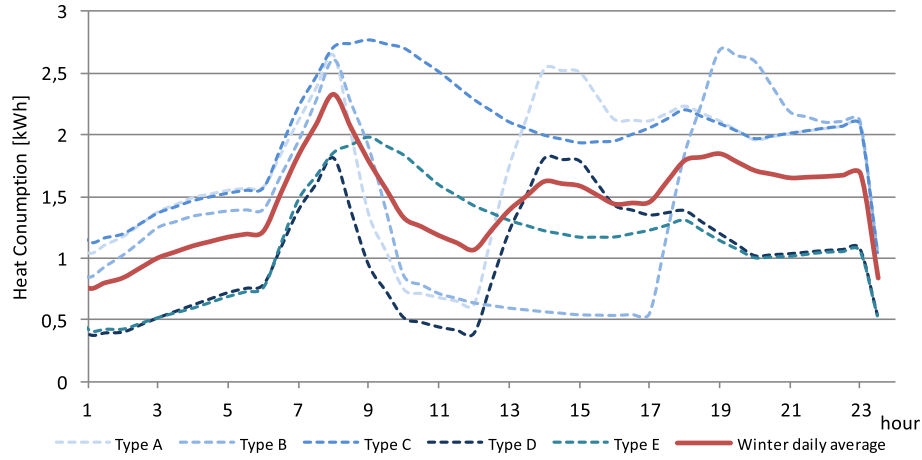

Fig. 2. Daily heat consumption for different household types for a winter day.

30–35 °C, approximately 150 L of water are needed [44]. Heat losses on hourly bases are assumed to be 4%, which corresponds to losses of 2% every half an hour. Heat storage has constraints due to its charge/discharge time:

$$H_{hs}(t, i) \leq C_{\max\_hs}(t, i) \cdot \tau \quad (8)$$

Storage energy content limit and behaviour are described with following inequalities:

$$C_{hs}(t, i) \leq C_{hs\_max}(t, i) \quad (9)$$

$$C_{hs}(t, i) = \eta_{hs}(t, i) \cdot C_{hs}(t-1, i) - H_{hs}(t, i) \quad (10)$$

### 3.4. Heat demand

Daily heat demand is modelled with 5 different curves which are evenly assigned among all households (Fig. 2). The mentioned figure represents demand curves for winter day. Similarly, 5 different curves are used for summer, and autumn/spring seasons. The heat consumption profiles are extracted from data available for United Kingdom [45]. Heat demand throughout the year is modelled with seasonal variations meaning that heat demand for

all winter days is represented with distribution of 5 winter demand curves among all households.

Heat demand of each household is modelled with following inequality where on one side is total heat demand of each household and on the other side production of associated  $\mu$ CHP ( $H_{chp}(t, i)$ ) or EHP ( $H_{ehp}(t, i)$ ) units with the addition of heat produced by auxiliary boiler units ( $H_{ab}(t, i)$ ) and heat from heat storage ( $H_{hs}(t, i)$ ):

To ensure the safe microgrid operation under all circumstances waste of heat is allowed:

$$H_d(t, i) \leq H_{chp}(t, i) + H_{ehp}(t, i) + H_{ab}(t, i) + H_{hs}(t, i) \quad (11)$$

Wasted heat  $H_{waste}(t)$  is calculated with the following equation:

$$H_{waste}(t) \leq \sum_{i=1}^K H_{chp}(t, i) + H_{ehp}(t, i) + H_{ab}(t, i) + H_{hs}(t, i) \quad (12)$$

### 3.5. Flexible electrical load

A simple model to represent demand side management is incorporated by defining a percentage of total electrical demand that can provide flexible response. Initially the percentage  $p_{flex}$  is set to be

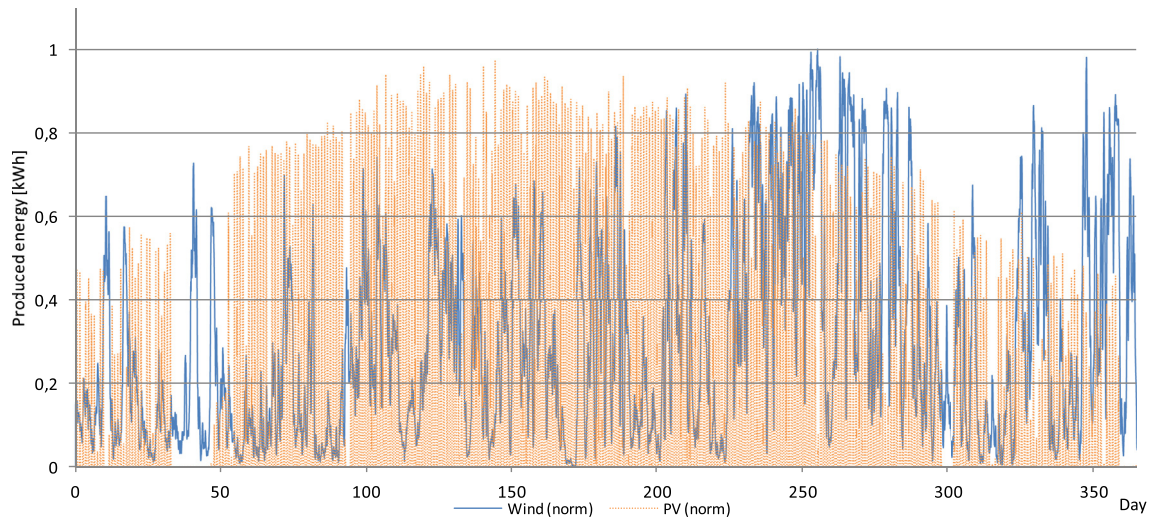

Fig. 3. Wind and solar production scaled to 1 kW of installed capacity.

15% of  $E_d(t)$  at any given period (Equation (13)). In the later analysis this percentage is varied searching of optimal flexibility value. Maximum value of realized flexible load at given time step is limited:

$$-p_{flex} \cdot E_d(t) \leq E_{flex}(t) \leq p_{flex} \cdot E_d(t) \quad (13)$$

$E_{flex}(t)$  is positive for load reduction and negative for load increase.

The information about the total amount of shiftable loads that are being rescheduled at every time step is modelled using flexible load maximum capacity which is modelled with continuous decision variable:

$$-C_{flex\_max} \cdot \tau \leq C_{flex}(t) \cdot \tau \leq C_{flex\_max} \cdot \tau \quad (14)$$

$$C_{flex}(t) = C_{flex}(t-1) - \sum_{i=1}^K E_{flex}(t, i) \quad (15)$$

$C_{flex}(t)$  is intertemporal variable that holds the information about the total amount of flexible load being rescheduled. This means that if the amount of flexible loads already being rescheduled has a value smaller than  $C_{flex\_max}$  then the available amount of load that can be rescheduled will not be  $p_{flex} \cdot E_d(t)$  but rather  $C_{flex\_max} - C_{flex}(t-1)$ . In this way the variable  $C_{flex}(t)$  ensures that not too much of load is being rescheduled throughout the whole simulation period. Having said this, this variable can be considered as a memory effect ensuring the comfort level of the consumer does not deviate too much from the desired level.

### 3.6. Renewable energy sources

Input data for RES modelling are hourly measured values over a one year period [46] depicted on Fig. 3. The input data is scaled for 1 kW of installed wind or solar power.

One of the goals of the off-grid model is to determine optimal installed values of wind turbines and PV arrays. Their production is defined as deterministic input data, multiplied their installed capacity ( $X_{wind}$ ,  $X_{PV}$ ) with production of 1 kW of installed capacity ( $E_{wind}$ ,  $E_{pv}$ ):

$$E_{wind\_real}(t) = E_{wind}(t) \cdot X_{wind} \quad (16a)$$

$$E_{pv\_real}(t) = E_{pv}(t) \cdot X_{pv} \quad (16b)$$

The correlation between consumption and PV production is much better than one with wind production. Therefore only wind curtailment is introduced:

$$E_{wind\_curt}(t) + E_{wind\_gen}(t) = E_{wind\_real}(t) \quad (17)$$

### 3.7. Electrical demand

Similarly to heat demand, electrical demand ( $E_d(t, i)$ ) is on a daily basis represented with different load consumption profiles for winter, spring/autumn and summer periods (Fig. 4) taken from the literature [45] which presents the results of an extensive study of demand profiles conducted by University of Strathclyde for the entire UK. The electricity demand is assumed to be similar in all households for every winter, summer and autumn/spring day.

Equilibrium between electricity production and consumption must be achieved at every time step where on the demand side are  $E_d(t, i)$  as electrical demand of household  $i$  in time step  $t$ ,  $E_{exp}(t)$  is exported electricity, and  $\sum_{i=1}^K E_{ehp}(t, i)$  is summation of all EHP in all households consumption. On the generation side  $E_{imp}(t)$  represent total import for simulation segment  $t$ ,  $E_{pv\_real}(t) + E_{wind\_gen}(t)$  are

RES total productions,  $\sum_{i=1}^K E_{chp}(t, i)$  is summation of  $\mu$ CHP units production in all households and  $\sum_{i=1}^K E_{flex}(t, i)$  the summation of deployed flexible loads.

$$E_d(t, i) + E_{exp}(t) + \sum_{i=1}^K E_{ehp}(t, i) = E_{imp}(t) + E_{pv\_real}(t) + E_{wind\_gen}(t) + \sum_{i=1}^K E_{chp}(t, i) + \sum_{i=1}^K E_{flex}(t, i) \quad (18)$$

### 3.8. Cost function

Total fuel used is equal to fuel used by boiler and micro CHP units:

$$F(t) = fuel_{chp\_total}(t) + fuel_{ab\_total}(t) \quad (19)$$

The natural gas price  $c_{ng}(t)$  is considered as constant value. Day-ahead market index prices are taken from ELEXON, a wholesale electricity market operator in the UK [39].

Minimization of total microgrid operation cost is the objective function of the model:

$$COST = \sum_{t=1}^{T_{max}} \left( F(t) \cdot c_{ng}(t) + E_{imp}(t) \cdot c_{imp}(t) - E_{exp}(t) \cdot c_{exp}(t) \right) + P \cdot E_{wind\_curt}(t) + P \cdot H_{waste}(t) \quad (20)$$

Penalty factor  $P$  is used to highlight the importance of avoiding energy waste and curtailing of potential wind production. The amount of unused energy correlates with the achieved microgrid flexibility. Factor  $P$  equal to 300 was used in off-grid simulation of a deterministic model when optimal RES installed values were determined in order to inhibit the waste of energy whenever possible.

## 4. Deterministic simulation results

The model described in the preceding section is run for  $i_{max} = 17520$  steps representing half an hour periods during one year time. The input data used was considered to be deterministic. All parameters are shown in the following table (Table 4). Micro CHP efficiencies can vary depending on the technology considered for the simulation; similar is the case for EHP units. Presented concept can be extended to these analyses and define how different efficiencies of observed technologies effect the provision of flexibility. The paper, however, focuses on the improvements in scheduling and extracting the existing flexibility in the microgrid for the purpose of reducing the operational cost and greenhouse gas emissions.

When off-grid operation is simulated variables  $E_{imp}(t), E_{exp}(t)$ , are set to be equal to 0.

As described before, high penalty factor  $P$ , in the objective function for waste energy, achieves that only 0.31% (12 989 kWh) of total energy spent has to be spilt (Fig. 5). Heat waste occurs in off-grid mode when there is not enough EE (electrical energy) production to cover the demand (little to no wind or sun); in those cases  $\mu$ CHP units have to produce more and consequently increase heat production which is not needed and cannot be stored in HS. Additionally, similar case happens when there is a surplus of electrical energy (high wind and sun generation) so optimization algorithm increases EHP heat production to balance the microgrid. Wind is curtailed in periods when there is a surplus of EE and there is no option of it being indirectly stored (indirectly in HS).

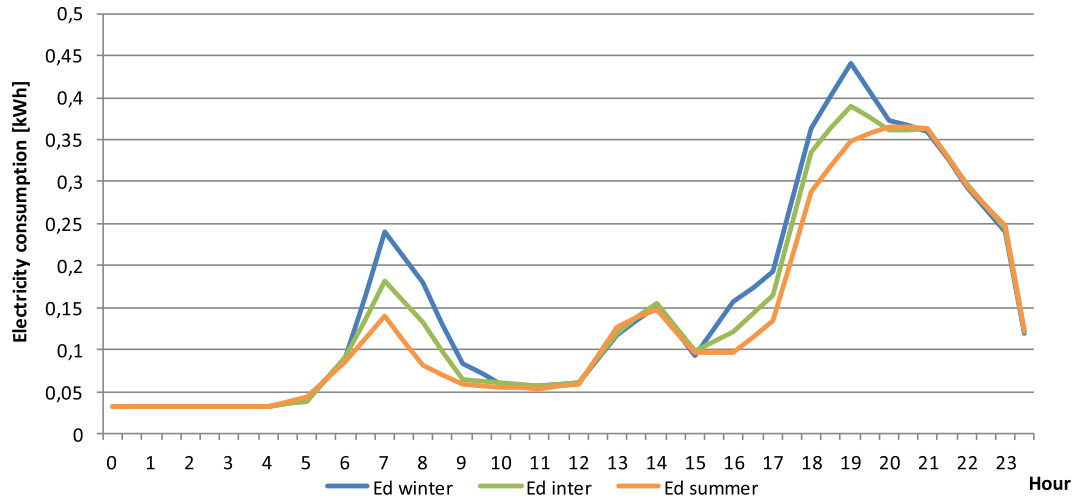

Fig. 4. Electrical demand profile for: 3 different seasons daily curves.

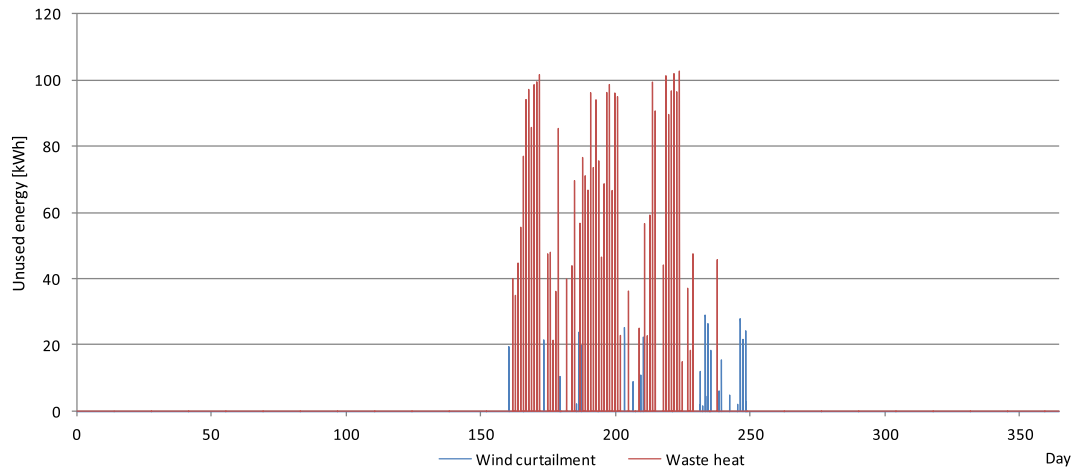

Fig. 5. Curtailed wind energy and surplus of produced heat energy.

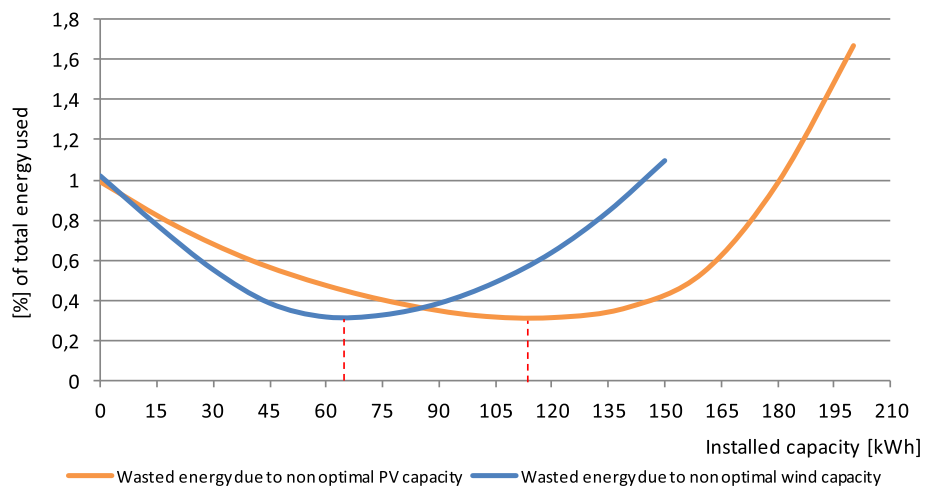

Fig. 6. Connection between installed RES capacity and unused energy.

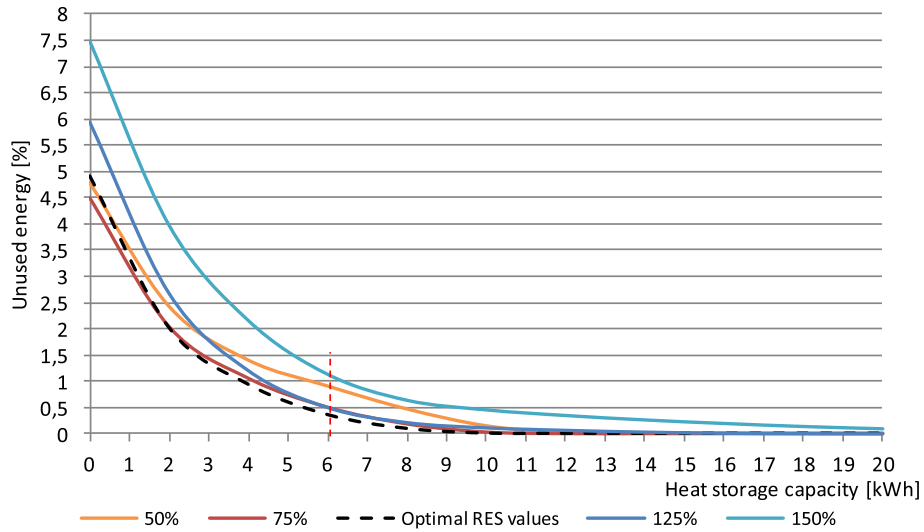

Fig. 7. Connection between HS maximum energy content and unused energy.

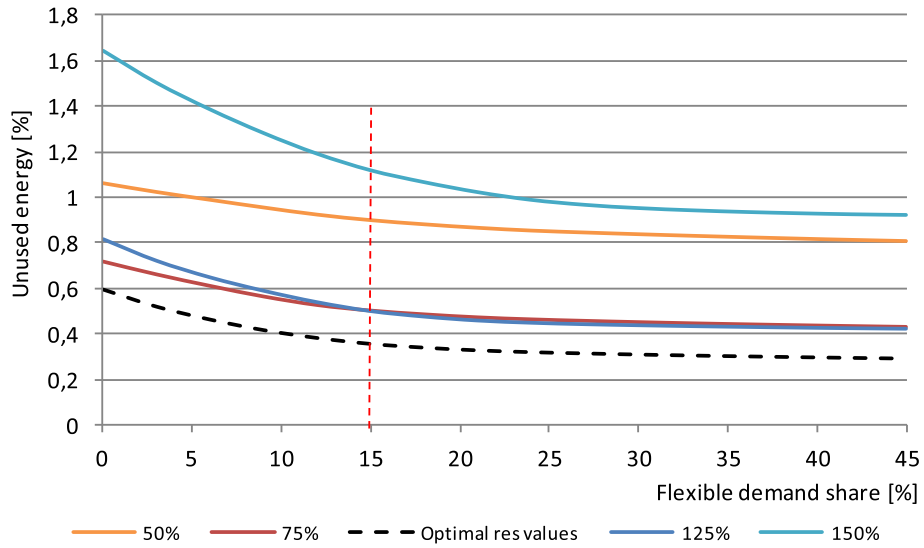

Fig. 8. Connection between flexible demand share and unused energy.

Sensitivity analysis of the change in installed wind and solar capacity was performed in order to show how non optimal values increase the total amount of curtailed wind and surplus of heat energy (Fig. 6). While one parameter was being changed the other was set at the optimal value. Optimal values of installed wind and solar power were calculated:

- $X_{wind\_opt} = 65 \text{ kW}$  and  $X_{PV\_opt} = 112 \text{ kW}$ .

These calculated values are later used as input parameters (reference values) in MPC model.

The possibility of storing heat energy is one of the elements that provide flexibility in grid operation. With large enough heat storage capacity  $\mu$ CHP units do not have to follow the demand. Furthermore, larger storage maximum energy capacity can compensate for the non-optimally dimensioned microgrid elements like installed power of RES. The results of the sensitivity analysis depicted on Fig. 7 show dependency of storage size and total unused energy for different installed RES capacities. Taking optimal sizes of RES units

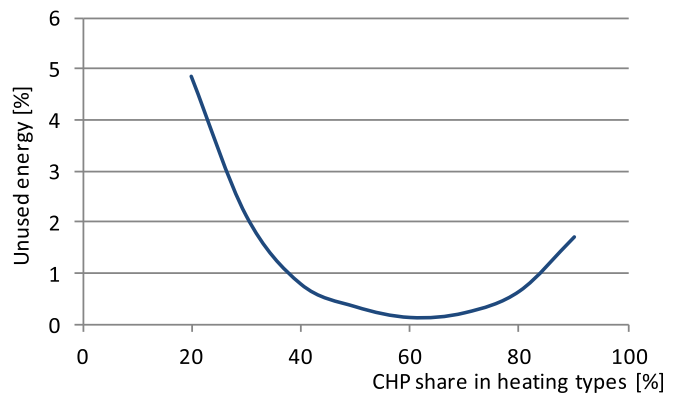

Fig. 9. Impact of CHP share in heating types on unused energy.

**Table 5**  
On-grid and off-grid operation comparison.

Microgrid operation indicator	Off-grid $P = 1$	Off-grid $P = 300$	Off-grid $P = 3000$	On-grid $\forall P^a$ ; initial	On-grid $\forall P$ ; optimal <sup>b</sup>
Total energy produced [kWh]	4192833	4190934	4190929	4177944	4177944
Total EE used [kWh <sub>e</sub> ] <sup>c</sup>	764926	764926	764926	764926	764926
Total heat used [kWh <sub>t</sub> ]	3559675	3559675	3559675	3413018	3413018
Wind curtailment [kWh]	1333	1301	1293	000	000
Wasted heat [kWh]	13557	11689	11581	000	000
Imported EE [kWh]	0.00	0.00	0.00	266934	206202
Exported EE [kWh]	0.00	0.00	0.00	547112	543607
CO <sub>2</sub> emissions [kg]	649560	649345	649410	535684	500849
Unused energy [%] <sup>c</sup>	0.360	0.310	0.308	0.00	0.00
Boiler production [kWh]	453697	453621	453541	87756	81244
Boiler fuel cost [€]	13344	13341	13304	2581	2281
Total Cost [€]	99625	99320	448 mil. €	78477	72044

<sup>a</sup> Value of penalty factor  $P$  has no effect on on-grid operation. Parameters for initial run are shown in Table 4.

<sup>b</sup> Optimal values: 60% CHP share, heat storage maximum energy content of 8 kWh, 15% flex demand.

<sup>c</sup> Percentage of total energy used.

the results show the optimal size of heat storage is 6 kWh<sub>t</sub> as values the waste of energy is below 0.5% of total energy used. In addition it can be seen that installing a storage unit double that size in every household, 12 kWh<sub>t</sub>, can reduce unused energy to values under 0.5% of total energy even in case when 50% more than optimal RES capacities are installed.

Similar analysis was conducted for flexible load share. Reference is the simulation with optimal values calculated before (Fig. 8).

Flexible demand has smaller influence on the unused energy compared to heat storage maximum energy content. The differences in unused energy for different FL shares are not as noticeable and curves get to the saturation point quite quickly.

Interesting information is provided by the analysis conducted to determine what impact different ratios of heating types ( $\mu$ CHP/EHP) has on the amount of unused energy.  $\mu$ CHP and EHP units complement each other in operation as seen in the wasted energy analysis, and together can provide a certain amount of flexibility. Results (Fig. 9.) show that the least value of unused energy is achieved if 60% of households have  $\mu$ CHP and 40% EHP based heating. Boiler based household heating type share is set to

0 during this sensitivity analysis meaning each household has either EHP or  $\mu$ CHP installed.

For a  $\mu$ CHP share of 10% in the off-grid mode the units have to be pushed to operate at their maximum point in order to produce enough EE and this leads to a lot of wasted heat that is used as an indicator for lack of flexibility. As the share moves beyond 60% there is not enough EHP electrical demand to balance periods of high RES generation and waste of energy occurs again.

4.1. On-grid simulation

The results have shown that the modelled microgrid can operate independently with very little unused energy. In case there is a connection with the rest of the distribution system the microgrid can exchange electrical energy with the system and its operation is driven by market signals. Results of both off-grid and on-grid operation are shown in Table 5.

It is shown that penalty factor has a certain influence on the amount of unused energy but the value saturates around 0.31% for  $P$  equal 300 and further increase of penalty factor does not achieve

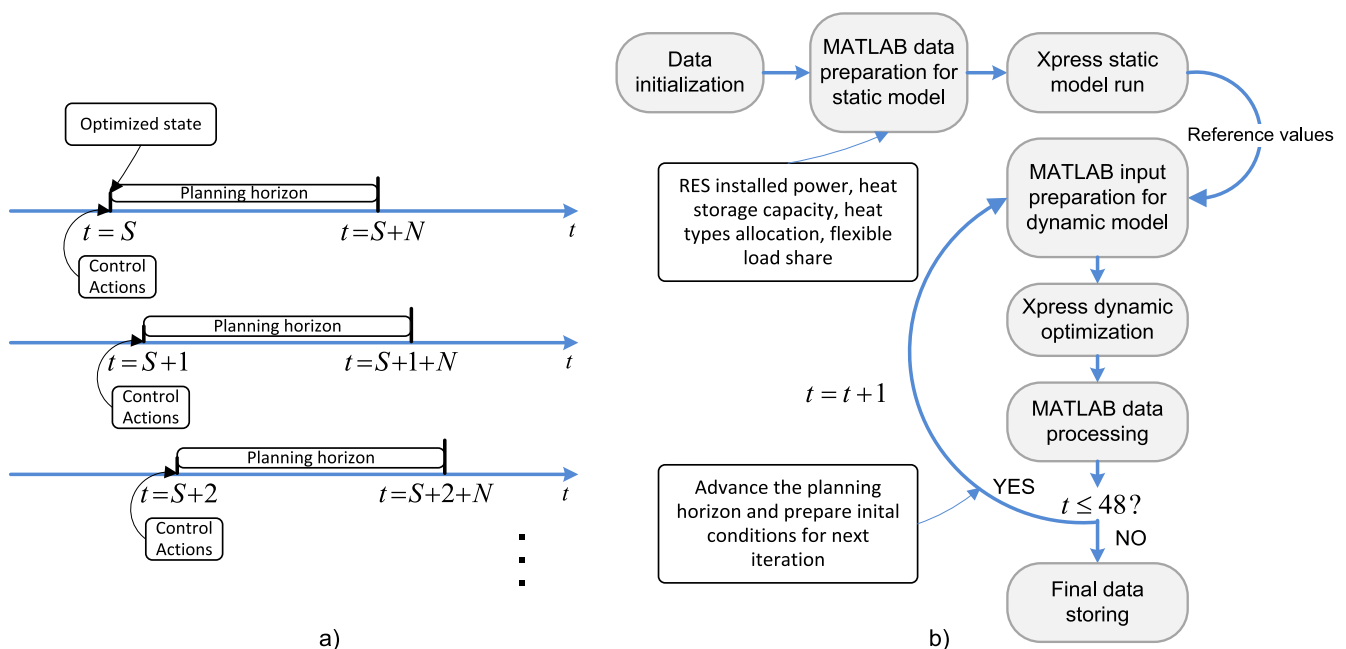

**Fig. 10.** a) MPC rolling horizon concept b) Flowchart of the MPC optimization model.

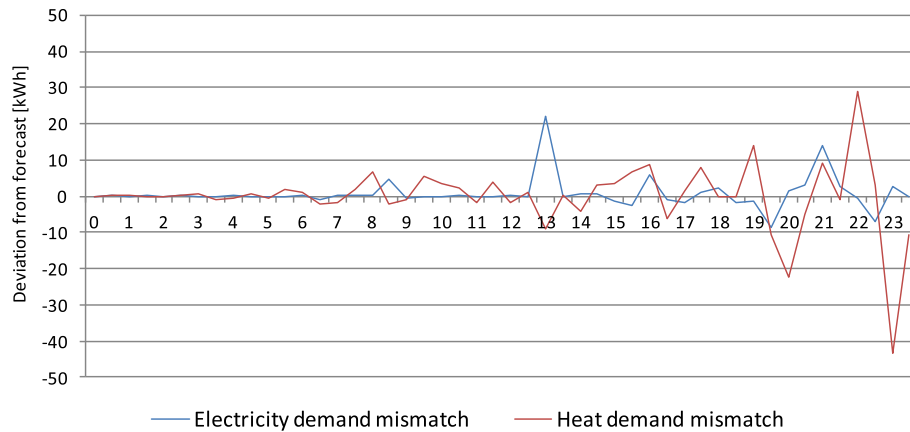

Fig. 11. Mismatch between realized and forecasted heat and electricity production.

better results. If every kWh of wasted energy wants to be penalized there is point where further increase of penalty does not achieve better results. The amount of wasted energy is almost equal for penalty of 300 and 3000 €/kWh] This means additional cost coming from this penalty for waste energy that sums up the total cost to 4,48 million € does not have a ground to be that high since the additional benefits are almost non-existent.

In case microgrid operates connected to the rest of the system (on-grid) there is no unused energy. Additionally the boilers are forced to produce much less heat compared to off-grid mode where they are used to balance the heat production and demand. Consequently, amount of fuel and the operational cost associated with boilers is reduced drastically.

The operational cost results presented in Table 5 take CO<sub>2</sub> emissions into account. The carefully selected parameters of heat storage and selected CHP share achieves 6.5% less emissions and 8.3% better overall costs compared to the initial on-grid run with parameters shown in Table 4. Additionally, investment costs could be introduced to get more precise information about the profitability of installing different microgrid units (battery storage, heat storage, RES, greater flexible load share, plug-in electric vehicles integration etc.). These expansions are a part of future work.

## 5. The rolling unit commitment model incorporating MPC

If a microgrid operates connected to the rest of the system, it participates in the energy market and its operation will be driven by market signals. In order to simulate dynamic behaviour of a microgrid the paper observes the microgrid as a single market entity/player. As such, it has to ensure self balancing and comply with the contracted exchange schedule at the day-ahead market. To be able to do that it has to consider forecasting errors and be able to reschedule if circumstance require, changing the operating points of flexible units as new information on uncertainty parameters becomes available. For this reason the extension of previously described deterministic model was made. The main goal was to investigate in what amount forecast uncertainties impact the microgrid operation and is the microgrid flexible enough to compensate the stochastic nature of RES installed and demand fluctuations. It is expected and desired that microgrid has at least neutral impact on grid, respecting proposed export/import schedules. All production and consumption variations should be balanced internally with controllable microgrid elements that can provide flexibility.

### 5.1. MPC (Model Predictive Control) framework

The results of a deterministic model have shown that the modelled microgrid can operate independently with very little unused energy in deterministic environment. In case there is a connection with the rest of the distribution system the microgrid can exchange electrical energy in desired time periods and energy waste is avoided. This interaction is even more important in stochastic environment where the need for balancing energy grows due to forecast errors.

The MILP unit commitment control algorithm employs MPC to minimize the impact of forecast errors. MPC is a control method which is used for discrete control; during one simulation step control signals do not change. The MPC concept and developed unit commitment algorithms flowchart are depicted on Fig. 10.

At every time step  $t$  the algorithm estimates the next  $N$  system states and reaches an optimal desired state. Control actions are applied and the state stays unchanged until the start of a new iteration. At the start of next time step  $t + 1$  again following  $N$  system states are estimated based on newly refreshed forecasts and based on realized input data for preceding iteration. In the developed model the planning look ahead horizon is 24 h because the microgrid participates in is day-ahead market.  $S \in [1,48]$  represents the current time period of the ongoing day. During one day, 48 half an hour time steps are simulated and in each, according to planning horizon, optimal state is specified taking into account future time steps. The solution of the optimization problem determines the power levels throughout the whole planning horizon considering the forecast uncertainty and sets the operational points accordingly. Precisely this enables the algorithm enhanced with MPC to outperform control that is only based on current state of the microgrid. For example: the wind suddenly stops at 6pm although strong winds were forecasted till 10pm. This will mean there is insufficient electricity in the microgrid and, to compensate for it, the microgrid operator has to buy it from the intra-day market. It should be noted that the initial wind was forecasted 36 h ahead (this is when most of day-ahead markets close) and the error is therefore large and missing electricity is relatively expensive. If the microgrid had the capability to reschedule its operation closer to the time of delivery (in the above example at 5.30pm) taking into account new wind forecasts, the deviation would be significantly lower. Another example can be shown through heat storage management coupled with the EHP unit. In low electricity price periods it is beneficial to generate additional heat and store it for later use when the price of electricity rises. Management based solely on



current state can deplete the heat stored too early. Once the price starts to rise and in case it keeps the trend the costs will be significantly higher since the heat will be produced during even higher electricity prices. Suggested MPC rolling horizon concept would on the other hand, in accordance to the planning horizon, foresee the electricity price increase and would produce more heat during low prices periods and reduce the heat storage discharge rate in order to preserve enough heat for the whole period of high prices and therefore minimize operational cost. The benefits of operation management optimization through the whole planning horizon are further expanded when microgrid has to deal with uncertainty. As it can be seen, the idea behind the MPC rolling horizon unit commitment is to develop a “microgrid controller” capable of dynamically<sup>1</sup> adjusting the operation points and by doing that alleviating the deviations which would otherwise occur. MPC has the role to adjust the microgrids current operating points but also to take into account future steps and leave the microgrid in good state. This means that unit commitment scheduling is performed at every time step ensuring the microgrid can change its operating points according to predicted demand, generation and exchange with the upstream system.

### 5.2. MPC model formulation

When introducing a stochastic element to the model, a range of error is defined for each forecasted data series:

- $E_d(t,i) \rightarrow \pm 4\%$
- $H_d(t,i) \rightarrow \pm 4\%$
- $E_{wind}(t) \rightarrow \pm 4\%$
- $E_{pv}(t,i) \rightarrow -90\%$  with 15% chance.

The bases for these values were predictions from the deterministic model that were modified by random number generator of normal distribution with standard deviation linearly increasing with the distance from current time step. Since the deviation increases with the advance from the start of day maximum error can occur at the end of planning horizon (24 h ahead). Additionally, for PV production 15% possibility to lose 90% of current power was added to imitate the common effect of clouding and introduce important stochastic element in PV production. Fig. 11 shows how the forecast error increases towards the end of planning horizon. Fig. 12 depicts RES production for a single day in absolute values acquired by the amplitude of error mentioned before.

Proposed microgrid operation is modelled in the following way:

1. Controller collects forecast data ( $E_d, H_d, E_{pv}, E_{wind}$ ) and estimates optimal microgrid operation based on the deterministic model. The planned import/export schedule is then sent to the DSO (distribution system operator) and becomes a reference;
2. In the first hour of the day controller acquires updated forecasts (for planning horizon) and accordingly deploys rolling unit commitment MPC model and adjusts control variables (operational set points of flexible units) to minimize operational cost. The mismatch from initially contracted exchange with the system is penalized in accordance with the imbalance prices;
3. In the next hour (next iteration) optimization is run again with updated forecast and information of the current state. The planning horizon is shifted forward;
4. Step 2 and step 3 are repeated until the end of the day  $S = 24$ .

Additional cost, coming from the forecast error, can be divided in two main components: (i) mismatch compensation for not following the announced and contracted import/export schedule with the market; (ii) fuel cost increase (e.g. more frequent boiler use). Total cost function is updated as the rolling horizon moves to the end of the day, making adjustments and taking into account the mismatch compensation for the realized periods and estimating costs from current hour till the end of the day (Equation (21)). The Equation (21) consists of 3 segments:

- i. first segment represents the expected cost (contracted exchange) done by the market index price;
- ii. second segment represents mismatch compensation cost where factor  $M_1$  modifies the market clearing price to imbalance system sell price SSP and factor  $M_2$  modifies market clearing price to imbalance system buy price SBP;
- iii. third segment “recalculates” the operating cost based on the present state of the microgrid and latest forecasts for the future time steps remaining till the end of the current day and start of new day-ahead settlement period.

The final operational cost for the ongoing day at every time step includes all three segments, therefore realized time segments and future time segments. It is calculated based on actual operating points. The brackets used in the Equation (21) are intended to clarify the long equation by dividing it and marking its constitutional segments:

$$\begin{aligned}
 \text{COST} = & \underbrace{\sum_{t=1}^{24 \cdot \tau^{-1} + 1 - S} \left[ F(t) \cdot c_{ng} + E_{imp0}(t) \cdot c_{mcp}(t) - E_{exp0} \cdot c_{mcp}(t) + P \cdot E_{wind\_curt}(t) + P \cdot H_{waste}(t) \right]}_{\text{Segment 1: Expected cost (Contracted exchange)}} \\
 & \left. \begin{aligned} & \left[ (-)short_{imp}(t) \cdot M_1 \cdot c_{mcp}(t) + long_{imp}(t) \cdot M_2 \cdot c_{mcp}(t) + \right. \\ & \left. short_{exp}(t) \cdot M_2 \cdot c_{mcp}(t) - long_{exp}(t) \cdot M_1 \cdot c_{mcp}(t) \right] \end{aligned} \right\} \text{Segment 2:} \\
 & \underbrace{\sum_{t=24 \cdot \tau^{-1} + 1 - S}^{24 \cdot \tau^{-1}} \left[ F(t) \cdot c_{ng} + E_{imp}(t) \cdot c_{mcp}(t) - E_{exp} \cdot c_{mcp}(t) + P \cdot E_{wind\_curt}(t) + P \cdot H_{waste}(t) \right]}_{\text{Segment 3: Future time steps (Deterministic reference cost) till end of current day}} \quad (21)
 \end{aligned}$$

$S$  marks how many iterations have passed from the start of the day,  $E_{imp0}$ ,  $E_{exp0}$  mark scheduled import/export of electricity. Variable  $short_{imp}$  is defined for negative mismatch in import,  $short_{exp}$  for negative mismatch in export,  $long_{imp}$  for positive mismatch in

<sup>1</sup> In the context of this paper dynamical is considered as time periods between two consecutive simulation steps.

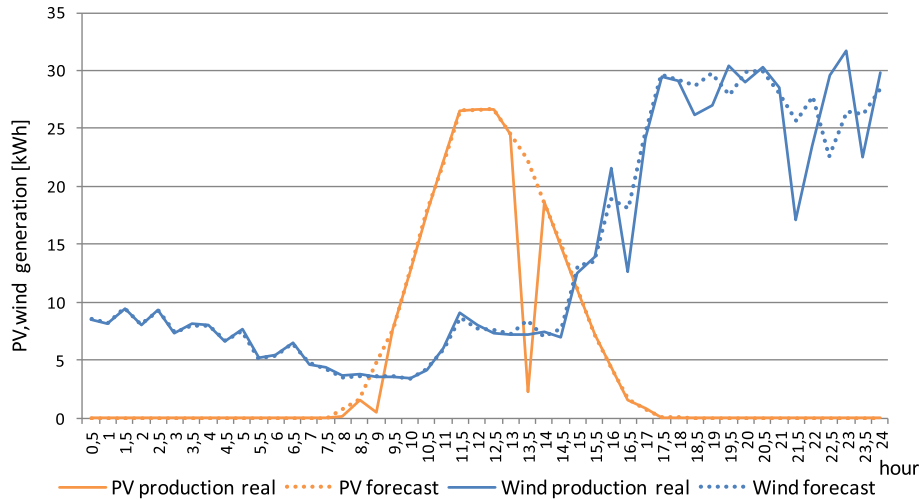

Fig. 12. Forecasted and realized RES production for first planning horizon ( $S = 0$ ).

import and  $long_{exp}$  for positive mismatch in export. The planned exchange is based on day-ahead market prices. Differences resulting from microgrids incapability to balance the uncertainty and variability of RES are traded by imbalance prices (system sell and system buy price) where factors  $M_1, M_2$  are reducing/increasing the market index price to obtain mentioned imbalance prices.

5.3. Results of the model incorporating MPC

Results are demonstrated for one winter day (24 h) with the demand profiles shown earlier (Figs. 2 and 6). Heat storage influence was observed closely and results are presented through several different analyses. Emissions of  $CO_2$  are calculated on the hourly bases and are compared for hourly management with no MPC and for case MPC is deployed. Additionally, sensitivity analysis

regarding the influence of forecast error and increase of imbalance prices was performed to test the quality of proposed MP control in various conditions.

The optimization goal was to reduce the total microgrid operation costs. Total operating cost from the deterministic model is used as the reference value. For the purpose of elaborating benefits of the proposed control algorithm the following cases were compared:

1. *DETERM. (Deterministic)*: presents a reference case.
2. *NO MPC*: the idea behind this case is to run the system as scheduled on day-ahead market. The deviation that would occur, without intraday corrections, would be “penalized” as they present unscheduled events (e.g. import/export) to the system/microgrid operator

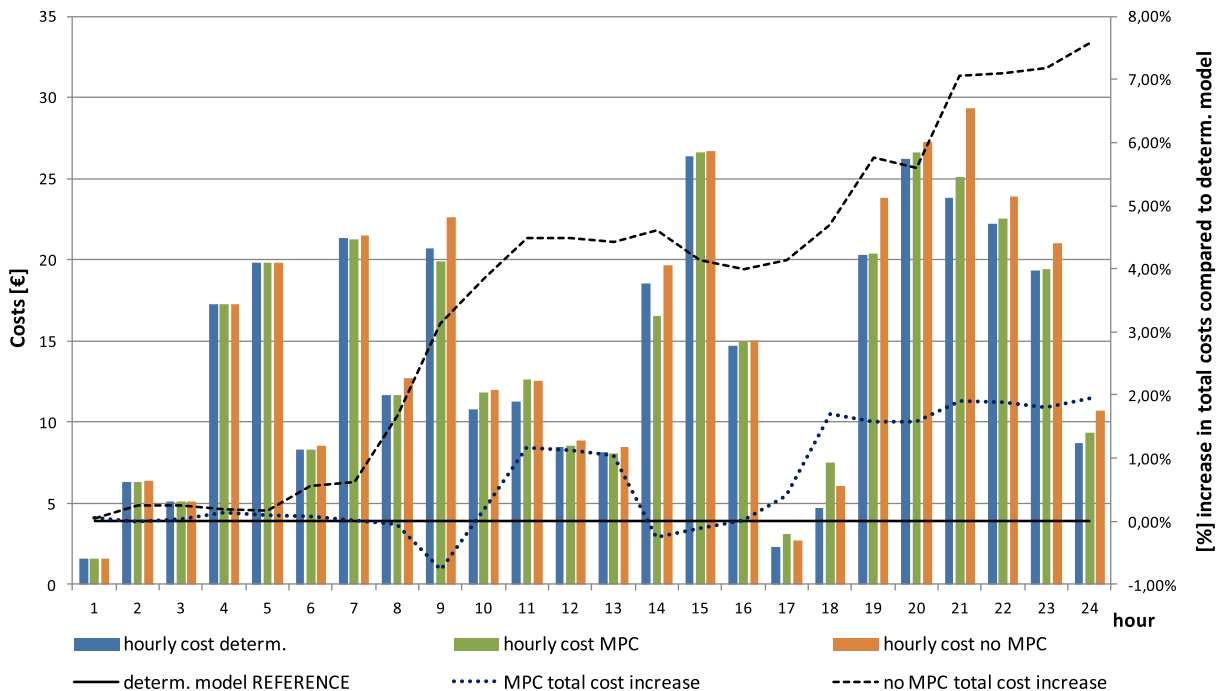

Fig. 13. Hourly costs comparison between hourly management with no MPC and proposed MPC model with 1.5% total energy forecast error.

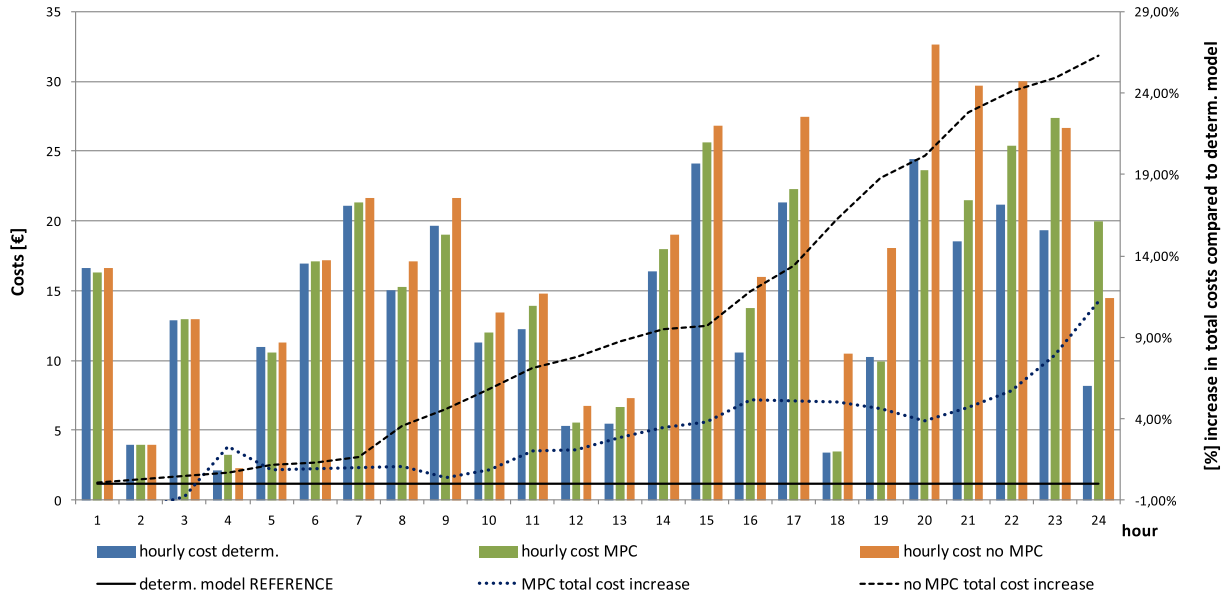

Fig. 14. Hourly costs comparison between hourly management with no MPC and proposed MPC model with 6% total energy forecast error.

3. MPC: the proposed control method in which the microgrid controller/operator attempts to correct its operation based on newly received forecast data. The main idea is to demonstrate how this approach is beneficial in terms of cost and emissions when compared to the previous test case.

Hourly costs are shown on Fig. 13. MPC model achieves only 2% worse result compared to deterministic reference. Compared to the per-hour management (*no MPC*) where analysis is based solely on the state in the current hour and decisions are made not considering the future planning horizon MPC achieves 7% better results. To elaborate; if there was no microgrid controller capable of adjusting the operation of flexible units, the microgrid acts as a variable source from the system perspective. Incapability of communicating intra-day exchange with the system constantly,

throughout the day, creates an imbalance and practically acts as an uncontrollable market entity, very similar to RES units.

On secondary axis increase in total costs compared to the reference deterministic model can be seen. Cumulative costs for hourly management with no MPC are increased 8% compared to deterministic reference. Total stochastic error in overall energy production introduced for the case presented on Fig. 13 is approximately 4% with amplitude of error mentioned on the beginning of Section 5.2.

Actual production of wind, solar and heat/electric demand, and correspondingly of the microgrid itself, deviates from the values forecasted day-ahead of delivery. Since these deviations are penalized, the total operational cost increases by 28% in case no MPC correction algorithm is used. On the other hand, when corrective action is used during the day based on the proposed MPC

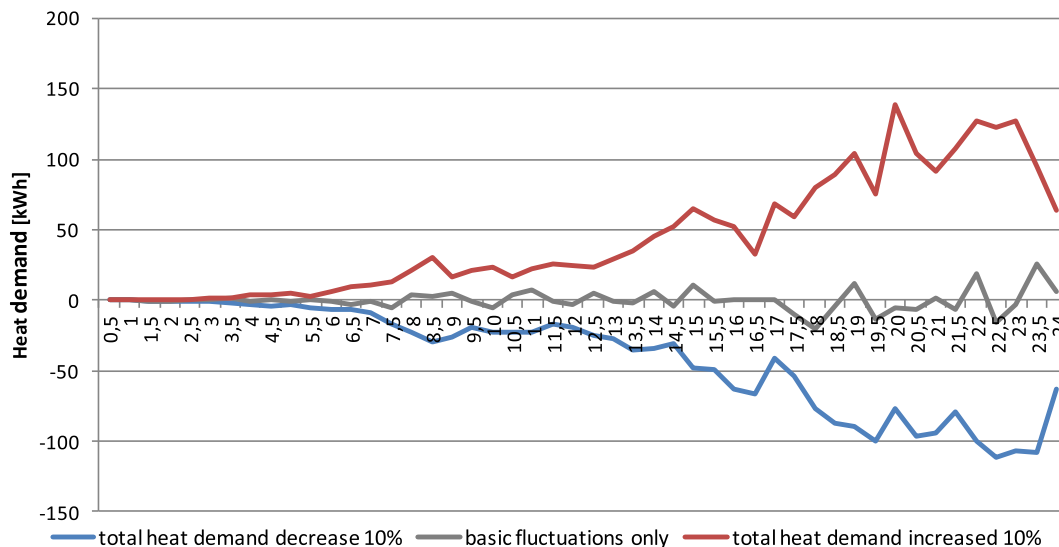

Fig. 15. Example of total heat demand forecast error.

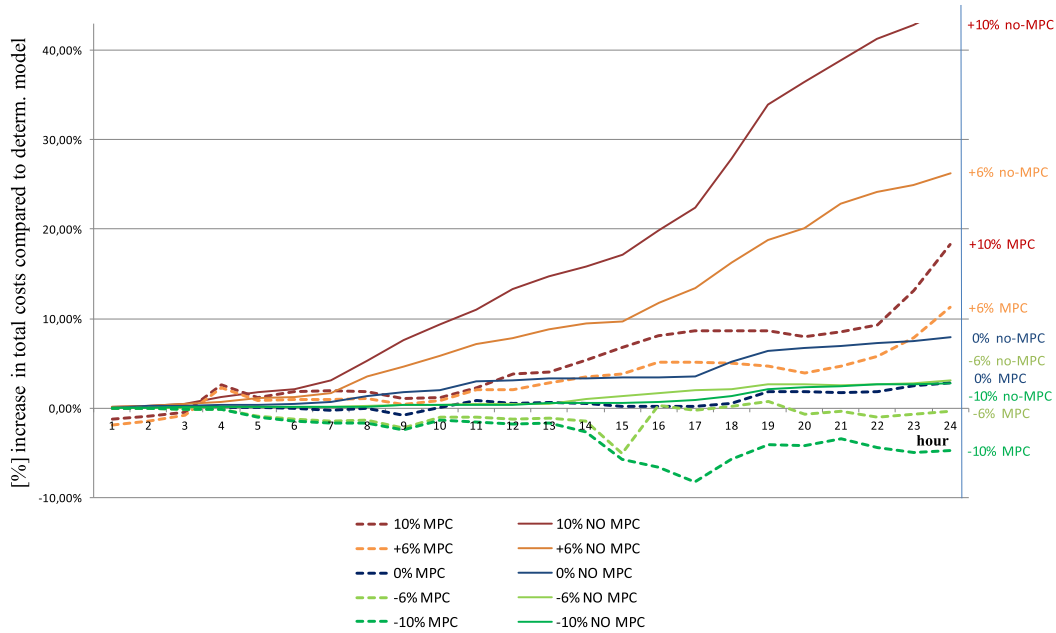

Fig. 16. Behaviour of no-MPC and MPC microgrid management for different levels of total change in heat demand ( $\pm 10\%$ ,  $\pm 6\%$  and  $0\%$ ).

algorithm, the operation cost increases only 12%. This is shown in Fig. 14. From these results it is clear how implementation of flexible control algorithm reduces the increase of costs, which inevitably occurs due to variable and uncertain nature of microgrid components (such as wind, solar, demand).

### 6. Stochastic model sensitivity analysis

In the following section sensitivity analysis regarding different aspect of potential causes of mismatch in microgrid operation is presented. Total energy mismatch can be caused by the increased amplitude of wind fluctuations or increase in total heat demand.

#### 6.1. Heat mismatch analysis

Gradual increase in total heat demand throughout the day due to not-forecasted temperature decrease in the evening can cause significantly different microgrid operation. Fig. 15 shows total change in heat demand equal to 10% of total heat demand. The total error is accumulated through one day and is caused by the imperfect forecasts of temperature and wind which lead to heat demand mismatch.

Detailed analysis regarding the microgrid reaction to heat demand forecast error for hourly management (i) with no MPC and (ii) with deployed MPC algorithm is shown in Fig. 16. It can be seen that flexible reaction of MPC controlled microgrid manifests

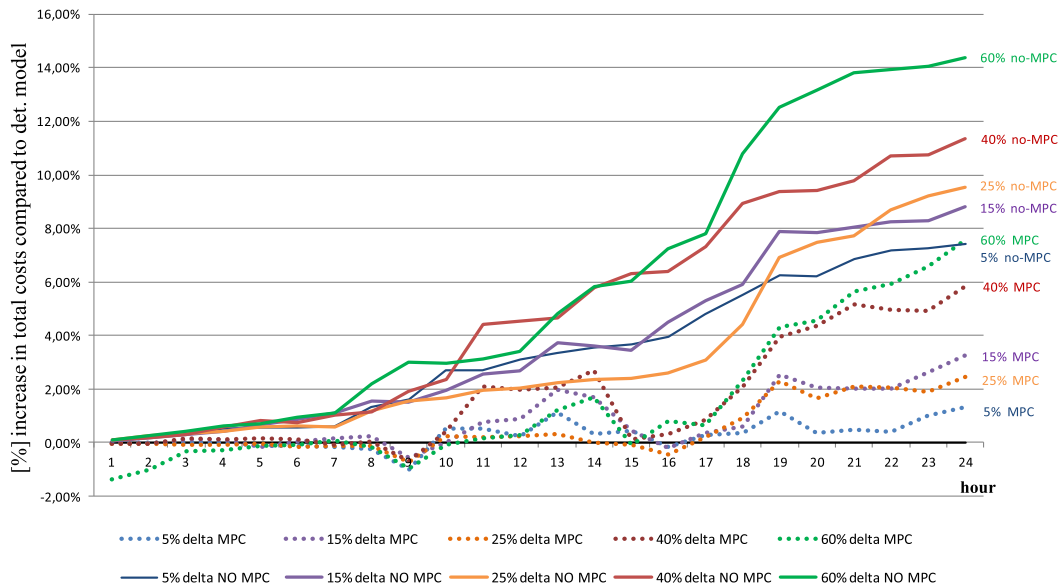

Fig. 17. Behaviour of no MPC and MPC microgrid management for different maximum magnitude of wind forecast error ( $\pm 5\%$ ,  $\pm 15\%$ ,  $\pm 25\%$ ,  $\pm 40\%$  and  $\pm 60\%$ ).

**Table 6**  
Operation indicators for different wind forecast magnitude errors.

Wind forecast error max amplitude [%]	Change in wind electricity production [%]	Total cost increase <sup>a</sup> [%]		Emissions increase <sup>b</sup> [%]	
		no MPC	MPC	no MPC	MPC
5%	1.11	7.42%	1.32%	3.32%	-2.74%
15%	4.55	8.82%	3.22%	3.13%	-0.87%
25%	16.21	9.84%	3.71%	3.34%	0.53%
40%	23.67	11.35%	5.81%	3.41%	1.13%
60%	35.80	14.39%	7.60%	3.96%	2.37%

<sup>a</sup> Deterministic reference equals 331,34 EUR.

<sup>b</sup> Deterministic reference equals 2689,27 kg of CO<sub>2</sub>.

smaller cost increase compared to deterministic reference. It can even decrease the total cost due to overall smaller heat demand. It should be noted that the amplitude of the error stays within  $\pm 2\%$  range in all cases and with this deviation the positive or negative accumulated change in heat demand is achieved. This way only the total imposed accumulated heat difference is changed to sum up to  $\pm 6\%$  or  $\pm 10\%$  values at the end of the day. This high total heat demand mismatch is not frequent in regular operation and is usually in the range of 2%. On the other hand this simulated case is used to test the algorithm over broad range of mismatches and prove its improvements compared to traditional no-MPC hourly management approach.

## 6.2. Wind production mismatch

The uncertain and variable nature of wind means forecast errors are manifested as both unexpected high ramp fluctuations and total

Similarly, Fig. 18 shows hourly CO<sub>2</sub> emissions in scenario with 25% wind error amplitude. In case no MPC is used total emissions are increased 3.34% compared to deterministic reference while MPC algorithm limits the increase to 0.53%.

## 6.3. Imbalance energy prices

This final sensitivity studies analyse the impact of imbalance prices on mismatch between scheduled import/export values, based on DA schedule, and actual exchange. The objective function takes into account all possible variations as shown in Table below (Table 7):

To modify the MCP (market clearing price) factor  $M$  was changed. Imbalance price SSP (System Sell Price) is lower than MCP while the SBP is higher than MCP. Accordingly second segment of Equation (21) (mismatch compensation cost) was modified:

$$COST = \dots + \left[ \begin{aligned} &(-)short_{imp}(t) \cdot (100\% - M) \cdot c_{mcp}(t) + long_{imp}(t) \cdot (100\% + M) \cdot c_{mcp}(t) + \\ &short_{exp}(t) \cdot (100\% + M) \cdot c_{mcp}(t) - long_{exp}(t) \cdot (100\% - M) \cdot c_{mcp}(t) \end{aligned} \right] + \dots \quad (22)$$

energy produced. One of the key challenges in future power systems is designing and operating a flexible system capable of responding to mismatch in wind production at any given time step. These deviations can be very high, especially in case of geographically non-dispersed units as is the case in microgrids. Therefore, it is important that proposed algorithm can offer robust response to these fluctuations.

It should be noted that the share of electricity from wind equals around 30% of total produced electricity in the microgrid, but only 3% of total energy used. Therefore, the increase of costs due to wind error is not as emphasized as in case of heat demand in Section 6.1. The benefits of using MPC algorithm are between 2% and 15% of the total daily operating cost, as shown in Fig. 17. Similar to results shown in previous section, the operating costs for “classic” and MPC algorithm are compared to the expected operation cost obtained day before the actual microgrid operation (this day-ahead (DA) value is presented as x-axis or 0.00% in Fig. 17). Due to forecasts errors the DA operational cost will never be achieved, however the goal is to deviate from it the least possible.

Table 6 shows benefits of using MCP (market clearing price) algorithm depending on total daily wind production mismatch. It can be seen that MPC algorithm not only corrects the operating points creating around 6% daily cost savings, it also reduces the overall daily CO<sub>2</sub> emissions of the microgrid. Since the difference in operational cost occurs due to increased exchange with the upstream system, these results suggest that using MPC algorithm is capable of reducing these fluctuations.

The imbalance prices are different from the market clearing price with the aim to stimulate market entities to provide flexibility services. However, if the price difference is small the market entity will not be driven to provide such services (the cost of producing additional electricity could be higher than the remuneration received for providing the service). With this sensitivity analysis it was shown that microgrid is flexible enough to reduce the mismatch from scheduled export/import plan to a certain extent but it can never eliminate it completely. Daily energy exchange mismatch is analysed for a broad range of price modification, factor  $M$  multiplying the market clearing price, and to get a more clear presentation Fig. 19 was “split” in two parts. Both parts of Fig. 19 have the same x-axis (increase of balancing price by factor  $M$  compared to market clearing price), however the second part “zooms in” to show the effect of very large values of  $M$  in reducing the mismatch in energy exchanged between microgrid and the system. The optimization problem was run 50 times for discrete values of factor  $M$  and average import and export mismatches are calculated and shown in Fig. 19.

From results depicted on Fig. 19 it can be seen that already a small change in prices compared to market clearing price reduces the amount of not planned energy exchange. In fact, factor  $M$  of 25% (meaning the imbalance prices are 125% of market clearing price) achieves only 17 kWh electricity exchange mismatch which equals to 0.0022% of total electricity used. Although this is not explicitly shown in Fig. 19 it should be noted that imported electricity can be reduced to 0 which means microgrid can compensate surplus of

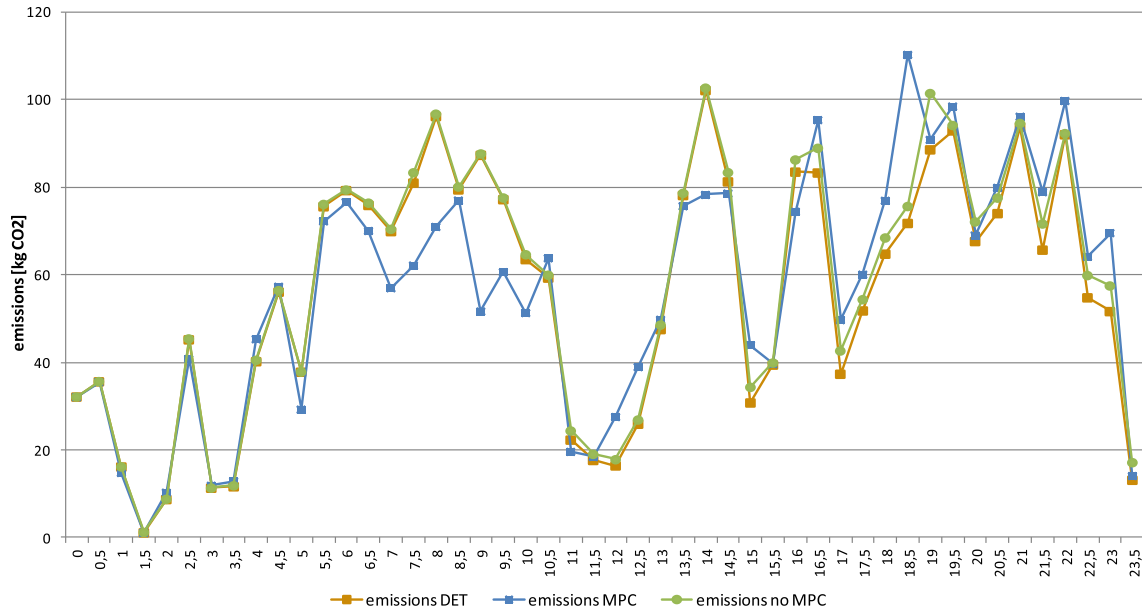

Fig. 18. Hourly CO<sub>2</sub> emissions.

Table 7  
Imbalance prices.

	System long	System short
Participant long	SSP	MCP
Participant short	MCP	SBP

energy produced by its components. On the other hand exported electricity saturates around 10 kWh which represents 0.0013% of daily used energy. Even if imbalance prices are drastically increased, microgrid in current configuration could not achieve perfect error compensation. Nevertheless, the amounts of exchanged energy are satisfyingly reduced demonstrating how appropriate market signals can be drivers of flexibility service provision [47].

7. Conclusion and future work

A novel concept based on MILP for modelling and optimization of microgrid operation has been presented. Deterministic model

was developed to investigate what is the impact of different units on microgrids ability to operate in the off grid mode. It was shown that defining optimal sizes of installed wind and PV in a microgrid leads to greater microgrid flexibility which is measured through the amount of curtailed production. In achieving the goal of flexibility increase important role belongs to optimal selection of CHP and EHP mix since these units have complementary role in heat and electricity production and/or consumption. Additionally heat storage has big impact on microgrid flexibility and selection of the accordingly chosen HS size is important for efficient microgrid operation.

Due to variability and uncertainty of production and consumption due to imperfections of existing forecast methods model predictive control with rolling horizon was developed simulating market driven behaviour of system connected microgrid. The MPC strategy achieves better results (lower costs) than simple deterministic day-ahead unit commitment strategy. It was shown that, with implemented MPC strategy, microgrid can almost completely balance the RES and load forecast uncertainty by intraday adjustments of operational set points of flexible units. It could be stated that microgrid with the incorporated proposed MPC control is

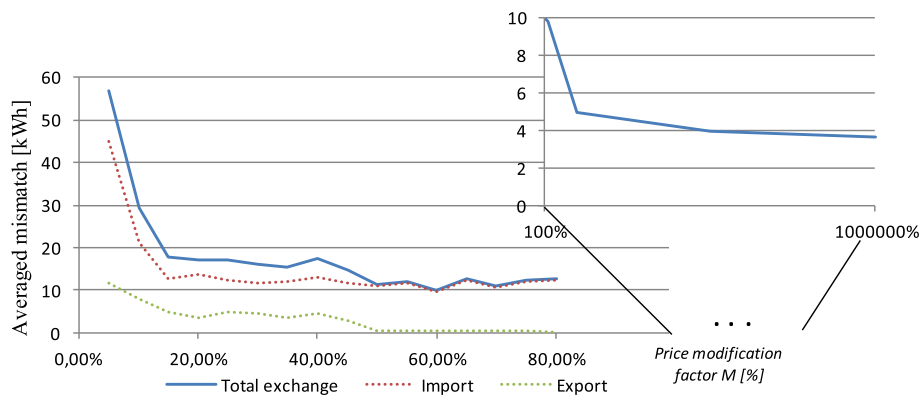

Fig. 19. Averaged energy mismatch depending on the factor M.

flexible in terms of capability to alleviate internal balances by re-dispatching its flexible units. This capability is an appealing option for microgrid operation in future low carbon systems as they move from being another variable market player, consequently a system harmer, to controllable and flexible participant, system helper.

Further work will focus on how a microgrid can achieve complete independence from distribution grid under stochastic framework. As it can be concluded from the work presented including battery storage systems seems to be a valuable source of flexibility in off grid operation. However it should be taken into account that economics behind installing them only for energy arbitrage will not be sufficient to justify them. In term, more detailed model capable of addressing frequency flexibility is needed. Adding more detailed behaviour of flexible loads and inclusion of electric vehicles will make the model even more conclusive.

### Acknowledgement

The work of the authors is a part of the Flex-ChEV -Flexible Electric Vehicle Charging Infrastructure project funded by Smart Grids ERA-Net under project grant No. 13 and FENISG- Flexible Energy Nodes in Low Carbon Smart Grid funded by Croatian Science Foundation under project grant No. 7766.

### References

- [1] Weber C, Shah N. Optimization based design of a district energy system for an eco-town in the United Kingdom. *Energy* 2011;36:1292–308.
- [2] Hatzigiorgiou N, Asano H, Iravani R, Marnay C. Microgrids. *IEEE Power Energy Mag* 2007;5(4):78–94.
- [3] Mancarella P. MES (multi-energy systems): an overview of concepts and evaluation models. *Energy* 2014;65:1–17.
- [4] Mancarella P. Cogeneration systems with electric heat pumps: energy-shifting properties and equivalent plant modelling. *Energy Convers Manag* 2009;50:1991–9.
- [5] Mancarella P, Chicco G. Real-time demand response from energy shifting in distributed multi-generation. *IEEE Trans Smart Grid* 2013;4(4):1928–38.
- [6] Mancarella P, Chicco G. Integrated energy and ancillary services provision in multi-energy system. In: 2013 IREP Symposium, Greece; 2013.
- [7] Kopanos Georgios M, Georgiadis Michael C, Pistikopoulos Efstratios N. Energy production planning of a network of micro combined heat and power generators. *Appl Energy* 2013;102:1522–34.
- [8] Sansaverino ER, Di Silvestre ML, Ippolito MG, De Paola A, Lo Re G. An execution, monitoring and replanning approach for optimal energy management in microgrids. *Energy Apr.* 2011;36:3429–36.
- [9] Pandzic H, Kuzle I, Capuder T. Virtual power plant mid-term dispatch optimization. *Appl Energy* 2011;101:134–41.
- [10] Pandzic Hrvoje, Miguel Morales Juan, Conejo Antonio, Kuzle Igor. Offering model for a virtual power plant based on stochastic programming. *Appl Energy* 2013;105:282–92.
- [11] Wang L, Wang Z, Yang R. Intelligent multiagent control system for energy and comfort management in smart and sustainable buildings. *IEEE Trans Smart Grid* 2012;3:605–17.
- [12] Basu A. Microgrids: planning of fuel energy management by strategic deployment of CHP-based DERs – an evolutionary algorithm approach. *Electr Power Energy Syst* 2013;44:326–36.
- [13] Hakimi SM, Moghaddas-Tafreshi SM. Optimal planning of a smart microgrid including demand response and intermittent renewable energy resources. *IEEE Trans Smart Grid* 2015;5:2889–900.
- [14] Fragaki Aikaterini, Andersen Anders N, David Toke. Exploration of economical sizing of gas engine and thermal store for combined heat and power plants in UK. *Energy* 2008;33:1659–71.
- [15] Capuder Tomislav, Mancarella Pierluigi. Techno-economic and environmental modelling and optimization of flexible distributed multi-generation options. *Energy* 2014;71:516–33.
- [16] Mehleri ED, Sarimveis H, Markatos NC, Papageorgiou LG. A mathematical programming approach for optimal design of distributed energy systems at the neighbourhood level. *Energy* 2012;44:96–104.
- [17] Carvalho M, Serra LM, Lozano MA. Geographic evaluation of trigeneration systems in the tertiary sector. Effect of climatic and electricity supply conditions. *Energy* April 2011;36(4):1931–9.
- [18] Moradi Mohammad H, Eskandar Mohsen, Hosseini S Mahdi. Operational strategy optimization in an optimal sized smart microgrid. *IEEE Trans Smart Grid* 2014.
- [19] Wang Zhaoyu, Chen Bokan, Wang Jianhui, Begovic Miroslav M, Chen Chen. Coordinated energy management of networked microgrids in distribution systems. *IEEE Trans Smart Grid* 2014;6(1):45–53.
- [20] Khodaei Amin. Provisional microgrids. *IEEE Trans Smart Grid* 2014;6(3):1107–15.
- [21] Arteconi A, Hewitt NJ, Polonara F. Domestic demand-side management (DSM): role of heat pumps and thermal energy storage (TES) systems. *Appl Therm Eng* 2013;51:155–65.
- [22] Marinelli M, Sossan F, Costanzo GT, Bindner HW. Testing of a predictive control strategy for balancing renewable sources in a microgrid. *IEEE Trans Sustain Energy* 2014;5:1426–33.
- [23] Larsen Gunn KH, van Foreest Nicky D, Scherpen Jacquelin MA. Distributed MPC applied to a network of households with micro-CHP and heat storage. *IEEE Trans Smart Grid* 2014;5:2016–114.
- [24] Malysz P, Sirouspour S, Emadi A. MILP-based rolling horizon control for microgrids with battery storage. *Industrial Electronics Society, IECON; 2013.* p. 2099–104.
- [25] Perković L, Ban M, Krajačić G, Duić N. Digital Proceedings of 8th Conference on Sustainable Development of Energy, Water and Environment Systems – SDEWES Conference. 2013. p. 494–518.
- [26] Madzharov D, Delarue E, D'haeseleer W. Integrating electric vehicles as flexible load in unit commitment modelling. *Energy* 2014;65:285–94.
- [27] Su Wencong, Wang Jianhui, Roh Jaehyung. Stochastic energy scheduling in microgrids with intermittent renewable energy resources. *IEEE Trans Smart Grid* 2014;5:1876–83.
- [28] Su Wencong, Wang Jianhui, Zhang Kuilin, Huang Alex Q. Model predictive control-based power dispatch for distribution system considering plug-in electric vehicle uncertainty. *Electr Power Syst Res* 2014;106:29–35.
- [29] Kivilouma Juha, Meibom Peter. Methodology for modelling plug-in electric vehicles in power system and cost estimates for a system with either smart or dumb electric vehicles. *Energy* 2011;36:1758–67.
- [30] Marietta M, Grealls M, Guerrero JM. “A rolling horizon rescheduling strategy for flexible energy in a microgrid”, presented at IEEE Energycon. 2014.
- [31] Parisio A, Rikos E, Tzamalīs G, Glielmo L. Use of model predictive control for experimental microgrid optimization. *Appl Energy* 2014;115:37–46.
- [32] Molderink A, Bakker V, Bosman M, Hurink J, Smit G. On the effects of MPC on a domestic energy efficiency optimization methodology. In: IEEE EnergyCon 2010; 2010. p. 120–5.
- [33] Ren H, Gao W. Economic and environmental evaluation of micro CHP systems with different operating modes for residential buildings in Japan. *Energy Build* 2010;42:853–61.
- [34] Deng Q, Gao X, Zhou H, Hu W. System modeling and optimization of micro-grid using genetic algorithm. In: 2nd Int. Conf. Intelligent Control and Information Processing; 2011. p. 540–4.
- [35] Piacentino A, Barbaro C, Cardona F, Gallea R, Cardona E. A comprehensive tool for efficient design and operation of polygeneration-based energy μgrids serving a cluster of buildings. Part I: description of the method. *Appl Energy* November 2013;111:1204–21.
- [36] Subramanian Kaushik, Rawlings James B. Economic model predictive control for inventory management in supply chains. *Comput Chem Eng* 2014;64:71–80.
- [37] Mahleri ED. Model predictive control of distributed energy resources. In: 2012 20th Mediterranean Conference on IEEE Control & Automation (MED); 2012. p. 672–8.
- [38] Houwing M, Negenborn RR, De Schutter B. Demand response with micro-CHP systems. *Proc IEEE* 2011;99(1):200–13.
- [39] Elexon. online: [www.elexon.co.uk/](http://www.elexon.co.uk/); October 2014.
- [40] Arteconi A, Hewitt NJ, Polonara F. State of the art of thermal storage for demand side management. *Appl Energy* 2012;93:371–89.
- [41] Kuzle Igor, Holjevac Tomislav, Capuder Tomislav. Model predictive control for scheduling of flexible microgrid systems. In: 9th Conference on Sustainable Development of Energy, Water and Environment Systems – SDEWES, Venice-Istanbul; 2014.
- [42] FICO Xpress. online: <http://www.fico.com/>; April 2014.
- [43] MATLAB. online: [www.mathworks.com/](http://www.mathworks.com/); April 2014.
- [44] Dincer Ibrahim. Thermal energy storage systems as a key technology in energy conservation. *Int J Energy Res* 2002;26:567–88.
- [45] Demand profile generators. University of Strathclyde; April 2014. online: <http://www.strath.ac.uk/esru/>.
- [46] Egaugue. online: [www.egaugue.net/](http://www.egaugue.net/); April 2014.
- [47] Electricity balancing significant code review – final policy decision. November 2014. online: <https://www.ofgem.gov.uk/publications-and-updates/electricity-balancing-significant-code-review-final-policy-decision>.

**Publication 3 - Defining Key Parameters of Economic and Environmentally Efficient Residential Microgrid Operation**

Holjevac, Ninoslav; Capuder, Tomislav; Kuzle, Igor. “Defining Key Parameters of Economic and Environmentally Efficient Residential Microgrid Operation”, *Energy Procedia*, vol. 105, 2017, pp. 999-1008

DOI: <https://doi.org/10.1016/j.egypro.2017.03.438>

- 10 pages





The 8<sup>th</sup> International Conference on Applied Energy – ICAE2016

## Defining Key Parameters of Economic and Environmentally Efficient Residential Microgrid Operation

Ninoslav Holjevac<sup>a\*</sup>, Tomislav Capuder<sup>a</sup>, Igor Kuzle<sup>a</sup>

<sup>a</sup>University of Zagreb Faculty of Electrical Engineering and Computing, Unska 3, 10000 Zagreb, Croatia

### Abstract

Aggregating consumers and distributed generation on the same location with coupled centralized control is the main advantage of a microgrid concept. If these consumers do not have the ability to balance the variability of the renewable energy sources (RES) production the microgrid can be perceived from the distribution system point of view as a potential imbalance source. Evaluating the potential flexibility benefits of different units in the microgrid provides a valuable step towards a successful integration of renewable energy sources.

This paper provides insight into different flexibility drivers of microgrid operation simulated in a developed mixed integer linear (MILP) model. The analyses focus on defining the impact of different storage size, control and location as well as different cogeneration unit technologies and efficiencies. These impacts are evaluated through several defined microgrid flexibility indicators, wasted heat and curtailed wind, considering operational techno-economic constraints of different microgrid components (battery storage, heat storage, micro combined heat and power units ( $\mu$ CHP)). Finally the interaction of the microgrid with the distribution system through the point of common coupling (PCC) in an hourly operation controlled by the rolling horizon unit commitment strategy is shortly described.

© 2017 The Authors. Published by Elsevier Ltd. This is an open access article under the CC BY-NC-ND license (<http://creativecommons.org/licenses/by-nc-nd/4.0/>).

Peer-review under responsibility of the scientific committee of the 8th International Conference on Applied Energy.

*Keywords:* microgrid; energy storage; flexibility; rolling horizon unit commitment

### 1. Introduction

Integration of renewable energy sources is today in a large share driven by incentives [1] and is a general goal of the European Union to increase the share of zero emission generation [2]. Investments and improvements on the distribution grid level will be needed to reduce the impact and balance the system with large shares of variable and unpredictable production from renewable energy sources [3].

The current “fit and forget” approach will therefore need to be replaced with a “smart grid” approach since the first requires large investments and leads to losses increase [5]. The second approach can

\* Corresponding author. Tel.: +38516129978; fax: +38516129890.

E-mail address: [ninoslav.holjevac@fer.hr](mailto:ninoslav.holjevac@fer.hr)

postpone the capital investments but requires installation of control and monitoring equipment which can enable integration of RES on the local level, e.g. microgrid level [5]. Traditionally all the imbalance between the production and consumption had to be compensated on centralized units whereas now the negative effect can be compensated for on local level. The idea of a virtual power plant [6], [7] is well known but still there is a lack of integral microgrid level models that can show the interaction between the microgrid and the rest of the distribution system, unit commitment among the microgrids distributed generators and enable flexible and robust response to all the possible fluctuations. In order to integrate all the requests optimal sizing of microgrid elements and efficient central control strategy is needed.

This paper presents main characteristics of the microgrid and problems that occur when dimensioning its elements. Furthermore, the operational flexibility term is defined and described and the possible flexibility services microgrids can provide to the system are mentioned. The developed MILP (Mixed Integer Linear Program) model and the developed rolling horizon unit commitment strategy based on model predictive control (MPC) are described and simulation results are presented.

## Nomenclature

$C_{t,i}^{bat}$	Capacity of a battery storage [kWh]
$C_{t,i}^{batMAX}$	Maximum capacity of battery storage [kWh]
$C_{t,i}^{hs}$	Capacity of a heat storage [kWh]
$c_t^{imp}, c_t^{exp}$	Import electricity price [€/kWh] / export electricity price [€/kWh]
$E_{t,i}^{bat}$	Battery charge/discharge energy [kWh]
$E_{t,i}^{chp}, E_{t,i}^{ehp}$	Electricity production of a $\mu$ CHP unit [kWh], Electricity production of a EHP unit [kWh]
$H_{t,i}^{chp}$	Heat production of a $\mu$ CHP unit [kWh],
$E_{t,i}^{ehp}, H_{t,i}^{ehp}$	Electric and thermal efficiency of a CHP unit
$E_{t,i}^d$	Electric demand of $i$ -th household [kWh <sub>e</sub> ]
$E_{t,i}^{flex}$	Flexible demand [kWh]
$E_t^{imp}, E_t^{exp}$	Imported electricity from the distribution grid [kWh], Exported electricity [kWh]
$E_t^{PV}, E_t^{wind}$	PV production [kWh], Wind turbine production [kWh]
$E_t^{wind\_curt}$	Curtailed wind energy [kWh]
$Fuel_t$	Total fuel used (CHP units and auxiliary boilers) [€]
$H_{t,i}^{hs}$	Heat flow through heat storage [kWh]
$H_t^{waste}$	Wasted heat [kWh]
	Duration of time step [kW]

## 2. Microgrid concept

Microgrid can be defined as a set of consumers, distributed generation and energy storages controlled in a coordinated manner with the aim of achieving reliable and predefined exchange with the rest of the distribution system through a point of common coupling (PCC) [8]. If possible all the imbalances are compensated on the microgrid level and the upstream system has no negative effects and the microgrid

can be considered to be fully flexible energy node (Fig. 1). The benefits microgrid concept can bring includes losses reduction, emissions reduction, and reliability of supply improvement, ancillary services support and easier integration of RES [9], [10].

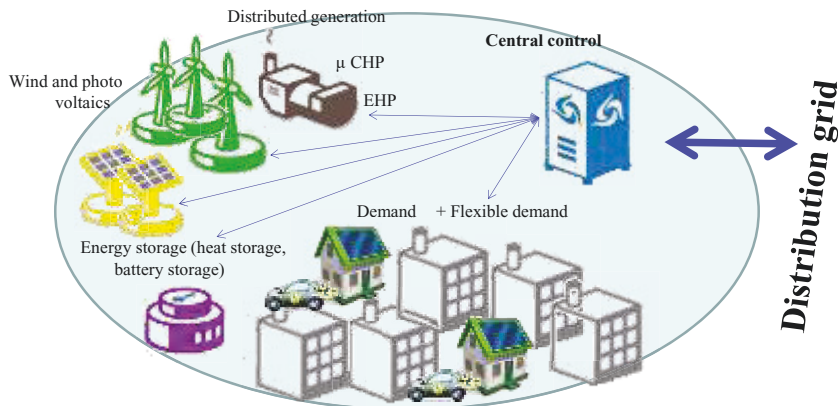

Fig. 1. Microgrid elements and the potential of connection of a microgrid as a flexible multi energy node through a PCC

The microgrid integrates various flows of energy, electricity, heat and gas. The coupled control of all energy vector unlocks additional potential, in the first place a flexible response to all the fluctuations. Therefore, the developed microgrid model (Fig 2.) includes all abovementioned energy vectors and enables additional flexibility benefits of coupled  $\mu$ CHP and EHP operation enhanced with heat and battery storage.

### 3. Operational flexibility

In future power system flexibility is becoming a key characteristic as an answer to an increasing share of variable generation. It can be defined as an ability to respond to changes in demand/generation equilibrium [11]. If market behavior of a certain entity is observed the flexibility can be defined as a capability to quickly adjust to most current market situation and follow the scheduled plan of exchange [12]. All power systems inherently have a certain flexibility level which was satisfactory until the unpredictability and variability of generation increased due to a large share of RES. In that circumstances it is a question how will an additional amount of RES effect the operation, how much of variable production current system can integrate and what are the changes needed to keep the present level of reliability. Lack of system flexibility can be manifested in frequency deviations which can lead to load shedding, deviations from contracted exchanges, wind curtailment, higher price volatility. The current system wide flexibility requirements prediction mostly base itself on deterministic calculation which increases the system costs and does not include the variables that stretch through several time periods (intertemporal constraints) [13]. With the advent of new technologies ( $\mu$ CHP, electric vehicles, flexible demand, electric heat pumps etc.) new flexibility potential can be unlocked on the local, distribution level [14]. Inclusion of all the units on the distribution level in the unit commitment problem requires formulation of new control concepts. Therefore, the evaluation how much of an impact different technologies have is a valuable information when dimensioning a microgrid system. This paper provides an insight how for example microgrid capabilities to provide flexible response change in dependence on the size of battery storage device.

### 4. Microgrid control

Microgrid control can be observed as a hierarchical structure (Fig 2.) [15], [16]. The lowest level is directly connected with the characteristics of the generator. The second level ensures the stabilization of frequency after the fluctuations. The second level keeps the frequency

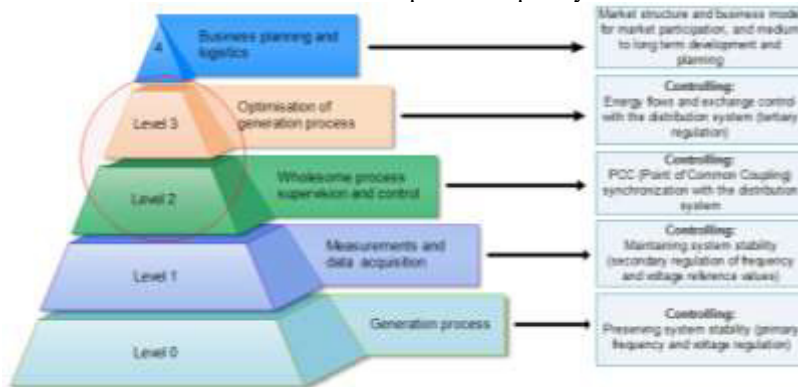

Fig. 2. IEC/ISA 95 standard hierarchy control adjusted for the observed microgrid concept

The developed model utilizes a central control system of higher level (Fig 2. – primarily level) with the assumption that the lower level control is efficiently implemented. The controller for the rolling horizon unit commitment uses model predictive control scheme (MPC). The basic idea of MPC control is shown on figure below (Fig. 3.).

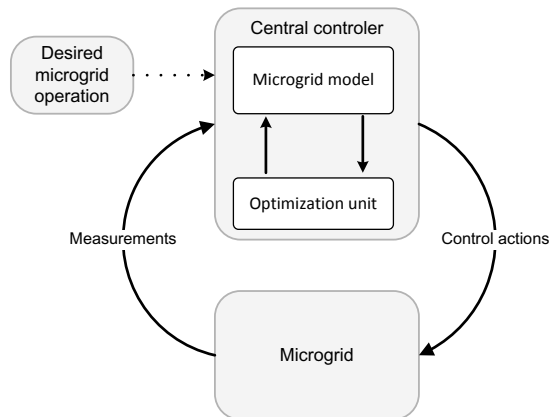

Fig. 3. Model predictive control concept applied to the developed microgrid model

For every simulation step  $t$  the control algorithm estimates the system state for the whole observed planning horizon. On the basis of the present state and forecasts for the planning horizon the optimal state is determined. This way both the current state and the future forecast errors are included in the scheduling. More detailed description of the iterative optimization process can be found in [17]. For the next simulation step the process is repeated. In this paper used planning horizon for the rolling unit commitment model is 24 hours since it is assumed the microgrid participates on the day-ahead market.

### 5. Microgrid simulation model

The developed MILP model described in [17] that represents a residential microgrid with 300 households of different load types was expanded with further elements. This paper presents results from a more detailed model that includes more precise  $\mu$ CHP unit model with different efficiencies and has a battery storage included.

The battery storage was modeled in two different ways:

1. Central battery storage– assumed that the investment into such battery could be done by the distribution system operator (DSO). The battery coordination is done together with distributed generation resources of the microgrid. The sensitivity analysis that shows how the flexibility indicators (wasted heat and curtailed wind) change for the different combination of installed capacities of RES and battery storage.
2. Distributed battery storage– assumed a percentage of households that have an EHP have a battery storage that enables even better utilization of coupled operation of  $\mu$ CHP units and EHP units. The sensitivity analysis was performed again. Additionally, since this is the more probable scenario the microgrid containing distributed battery storage governed by the adaptive rolling horizon unit commitment was simulated to operate on a day ahead market. The results showing the reduction in environmental impact, e.g. less need for the usage of gas for  $\mu$ CHP units, are presented.

The battery for a central model is incorporated with the following equations. Maximum value of energy flow through battery (charge/discharge) at any given time step is limited and connected with the maximum capacity of the battery (Eq. 1)). It is assumed that, for example, in a time simulation step of a half an hour the battery can be charged to one eight of its capacity.

$$C_t^{batMAX} \quad 4) \quad dsc \quad E_t^{bat\_tot} \quad C_t^{batMAX} \quad 4) \quad charge \quad (1)$$

$E_t^{bat}$  is positive for battery charging and negative for battery discharging. The information about the total battery capacity at every time step is modelled with continuous decision variable.  $C_t^{bat}$  is intertemporal variable that holds the information of the central capacity.

$$C_t^{bat} \quad C_t^{batMAX} \quad (2)$$

$$C_t^{bat} \quad L \quad C_{t-1}^{bat} \quad E_t^{bat\_tot} \quad (3)$$

On the other hand, the battery model for the batteries distributed among households (K is the number of households) is described with the following constraints:

$$E_{t,i}^{bat} \quad C_{t,i}^{batMAX\_dist} / (4 \quad (4) \quad C_{bat\_dist}(t) \quad C_{batMAX\_dist} \quad (5)$$

$$E_t^{bat\_tot} \quad \sum_{i=1}^K E_{t,i}^{bat} \quad (6)$$

The production of the  $\mu$ CHP unit is limited with minimum and maximum power output (equation 7). The fossil fuel used is natural gas (equation 8). The heat and electricity production are linked with thermal and electrical efficiencies (equation. 9).

$$H_{t,i}^{CHP\_min} \quad H_{t,i}^{CHP} \quad H_{t,i}^{CHP\_max} \quad (7) \quad fuel_t^{chp\_tot} \quad \sum_{i=1}^K \frac{H_{t,i}^{chp}}{E_{chp_{t,i}}} \quad (8)$$

$$E_{t,i}^{chp} = H_{t,i}^{chp} \frac{E_{t,i}^{chp}}{H_{t,i}^{chp}} \tag{9}$$

Equilibrium between electricity production and consumption must be achieved at every time step:

$$E_{t,i}^d - E_{t,i}^{exp} + \sum_{i=1}^K E_{t,i}^{chp} - E_{t,i}^{imp} - E_{t,i}^{pv} - E_{t,i}^{wind\_gen} + \sum_{i=1}^K E_{t,i}^{chp} - \sum_{i=1}^K E_{t,i}^{flex} - E_{t,i}^{bat\_tot} \tag{10}$$

The objective function for the simulations that generated sensitivity analysis calculates the yearly operational costs (17520 half an hour time steps). In the yearly simulation no stochastic error of forecast is used. Penalty factor *P* is used to highlight the importance to use all the available energy and avoid the waste of heat and wind curtailment. Factor *L* highlights the importance of efficient use of energy. It discourages cycling of energy of the battery with an introduction of a small amount of losses (0.05%).

$$COST = \sum_{t=1}^{T_{max}} Fuel_t c_t^{ng} - E_t^{imp} c_t^{imp} - E_t^{exp} c_t^{exp} + P E_t^{wind\_curt} + P H_t^{waste} + L E_t^{bat\_tot} \tag{11}$$

**6. Results**

Conducted analysis of the battery storage impact and distributed generation efficiency has on an operation of a microgrid shows that specific elements have higher impact. The results from a set of simulations for different μCHP technologies [18] are shown in Table 1. The total share of μCHP units in households is set to be 50%, share of EHP units 20% and the rest of the households had only auxiliary boiler as a heating source. The off-grid operation mode was used, export and import were not allowed. It can be seen that the capability of a microgrid to integrate RES is highly dependent on the technology used for the μCHP units that represent a most important heat source in the microgrid. Additionally, since there is a possibility to shed the wind, with the addition of battery storage the PV installed capacity rises.

Table 1. Dependence of the microgrid capability to integrate RES on the μCHP technology used

μCHP technology	Efficiency [%]		Optimal PV installed capacity [kW]		Optimal WIND installed capacity [kW]		Wasted energy		Total emissions [tons]	Percent of el. demand met from RES
	Elec.	Therm.	No bat.	Battery	No bat.	Battery	Heat <sup>1</sup>	Wind <sup>2</sup>		
Fuel cell	30	55	72	82	72	68	1,04%	4,37%	813	36,93%
Stirling engine	20	77	60	69	188	178	0,84%	27,19%	783	61,84%
Comb. engine	26	64	60	71	109	102	2,86%	9,57%	794	45,48%
Steam engine	24	70	58	67	137	130	4,75%	15,33%	778	51,71%
μ gas turbine	25	58	62	75	99	91	2,33%	7,73%	833	43,11%

<sup>1</sup>In percent to the total heat used // <sup>2</sup>In percent to the total wind production

If the wasted energy share is observed for all the μCHP technology types the addition of battery storage in all cases reduces the unused energy amounts (Fig. 4).

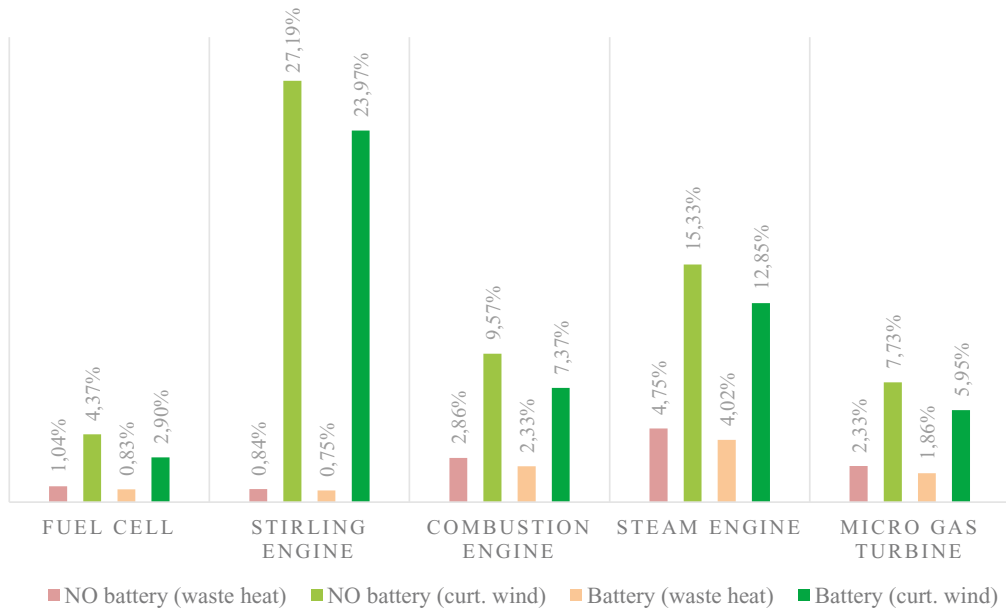

Fig. 4. Unused energy amounts for microgrid with and without the battery storage (in percent to total heat used || total wind energy production)

The optimal capacity of total installed RES changes with the addition of battery storage. So does the amounts of wasted energy which are reduced. The sensitivity analysis is performed for both central battery and distributed battery storage. The observed wasted energy for different installed capacities of RES is shown on Fig. 5. All other parameters are kept unchanged during these simulations. Optimal RES values for a case without any storage are 109 kW of installed wind power and 60 kW of installed PV.

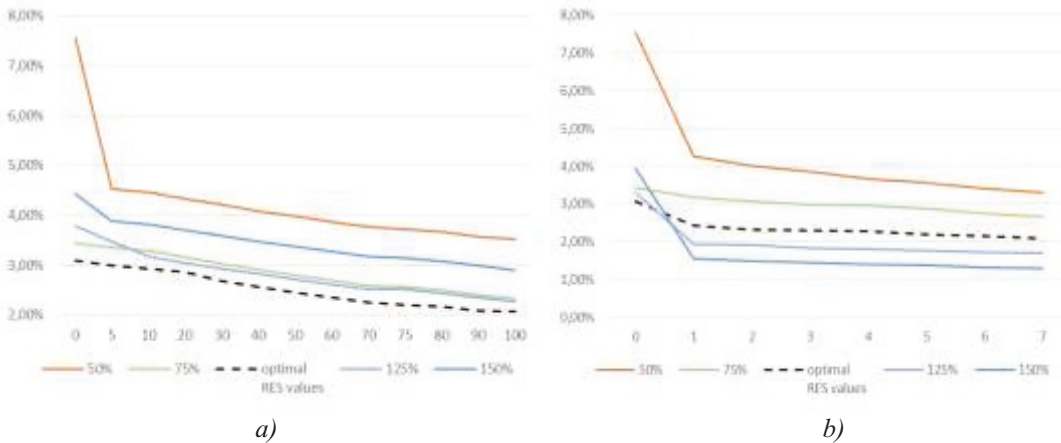

Fig. 5. Sensitivity analysis for battery storage size and unused energy amount (a) Central battery storage; (b) Distributed battery storage

It can be seen that the slowly decreasing trend is present in both cases and the biggest additional value of battery is observable at the first addition of battery capacity. It is interesting to observe that battery has a greater effect for smaller capacity of RES because it enables the better utilization of  $\mu$ CHP units

electricity production which is forced to produce more electricity. Since electrical and thermal outputs are connected at certain simulation periods waste of energy occurs. Additionally, the distributed battery storage enables higher level of RES integration but also all the households distributed batteries altogether have a bigger total capacity and total investment costs. The optimal installed values for a series of small 3 kWh batteries increases to a total 300 kW of installed wind and 138 kW installed PV. This is the reason why the sensitivity analysis for higher installed capacities returns better operation indicators since the control algorithm has even more resources it can use to avoid the waste of heat and totally eliminate curtailment of wind and cover almost 100% of electricity demand from the RES.

Results of the model incorporating rolling horizon predictive control are demonstrated for one winter day (24 hours). The simulations include demand and renewable energy resources forecast error. The control algorithm in every time step gathers the most recent forecasts and based on them, current state of the microgrid and announced day-ahead exchanges optimizes the microgrid operation. The goal is to follow the contracted day ahead exchanges while at the same time balancing and alleviating the impact of the unpredictable RES production.  $\mu$ CHP unit dispatch for an observed winter day is depicted on Figure 6. The results are presented for operation with and without storage. In case no storage is available it can be seen that  $\mu$ CHP units are following the heat demand which shows that EE price was high enough to justify the use of cogeneration. If storage is available bigger production in periods of high EE prices can be observed while it is less costly to burn natural gas. This reduces total emissions and costs. On the other hand, when the electricity is cheap it is used to produce and store heat and electricity for upcoming periods. As it was already shown on the yearly operation the storage capacities enable the microgrid to utilize its resources more efficiently.

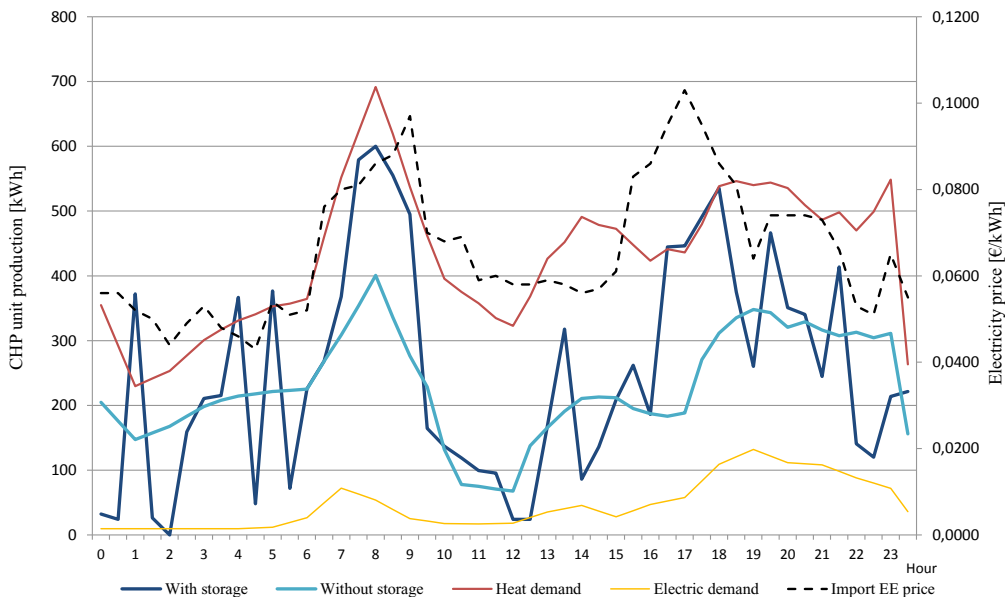

Fig. 6.  $\mu$ CHP unit operation in the daily simulation governed by the adaptive rolling horizon unit commitment algorithm

## 7. Conclusion

This paper presents a possibility to deal with the RES integration problem on a local level, inside the microgrid system. The prerequisite for that is a design of a satisfactory control algorithm that can provide enough flexibility. In accordance, the paper presents the detailed MILP model of a residential microgrid



consisting of 300 households and that has included all the important distributed generation technologies,  $\mu$ CHP, EHP; RES and with special highlight how storage technologies effect the operation. The paper differentiates two different simulation types. The first that was explained in more detail is the yearly operation simulation that is used for the dimensioning of microgrid elements and for general evaluation what an impact they have on microgrid flexibility. The paper proposes waste of energy to be an indicator of operation that shows how flexible microgrid is in responding to fluctuations in RES generation. The second series of simulations give a glimpse of results obtained from the daily operation of microgrid entity that participates on the day-ahead market and is governed by the adaptive rolling horizon control algorithm. It is shown that the usage of proposed algorithm increases efficiency of the distributed generation utilization.

## 8. Copyright

Authors keep full copyright over papers published in Energy Procedia.

## Acknowledgements

The work of the authors is a part of the IRES-8 and BIL-IRES-8 projects - Instigation of Research and Innovation Partnership on Renewable Energy, Energy Efficiency and Sustainable, Energy Solutions for Cities funded by European Union.

## References

- [1] M. G. Pollit, The future of electricity (and gas) regulation in a lowcarbon policy world, *Energy Journal*, vol. 29, pp. 63–94, 2008.
- [2] P. Siano, Assessing the Impact of Incentive Regulation for Innovation on RES Integration, *IEEE Transactions on Power Systems.*, vol. 29, pp. 2499–2508, 2014.
- [3] L. Baringo and A. J. Conejo, Wind power investment within a market environment, *Applied Energy*, vol. 88, no. 9, pp. 3239–3247, 2011.
- [4] A. Piccolo and P. Siano, Evaluating the impact of network investment deferral on distributed generation expansion, *IEEE Transactions on Power Systems*, vol. 24, no. 3, pp. 1559–1567, 2009.
- [5] R. Cossent, T. Gómez, and P. Frias, Towards a future with large penetration of distributed generation: Is the current regulation of electricity distribution ready? Regulatory recommendations under a European perspective, *Energy Policy*, vol. 37, no. 3, pp. 1145–1155, 2009.
- [6] N. Hatzigryriou, H. Asano, R. Iravani, and C. Marnay, , *Microgrids*, *IEEE Power & Energy Magazine*, 2007.
- [7] H. Pandzic, I. Kuzle and T. Capuder, Virtual power plant mid-term dispatch optimization, *Applied Energy*, vol 101, pp. 134-141, 2011.
- [8] E. Olivares, A. Mehrizi-Sani; A.H. Etemadi; C.A. Canizares, R. Iravani,; M. Kazerani, A. H. Hajimiragha; O. Gomis-Bellmunt; M. Saadifard, R. Palma-Behnke, G.A. Jimenez-Estevez, and N. D. Hatzigryriou, *Trends in Microgrid Control*, *IEEE Transactions on Smart Grid*, vol. 5, pp. 1905-1919, 2014.
- [9] M. Hakimi, S. M. Moghaddas-Tafreshi, Optimal Planning of a Smart Microgrid Including Demand Response and Intermittent Renewable Energy Resources, *IEEE Transactions on Smart Grid*, Vol. 5, pp. 2889-2900, 2014.
- [10] K. Dietrich, J.M. Latorre, L. Olmos, A. Ramos, Demand Response in an Isolated System With High Wind Integration, *IEEE Transactions on Power System*, vol. 27, pp. 20-29, 2012.
- [11] E. Lannoye, D. Flynn and M. O'Malley, Evaluation of power system flexibility, *IEEE Transactions on Power Systems*, vol. 27, pp. 922-931, 2012.
- [12] Group of authors: „Flexibility in 21st Century Power Systems“, *National Renewable Energy Laboratory*, 2014.
- [13] N. Troy, E. Denny, and M. O'Malley, Base-loadcycling on a system with significant wind penetration, *IEEE Transactions on Power Systems*, vol. 25, pp. 1088-1097, 2010.
- [14] T. Capuder and P. Mancarella, Techno-economic and environmental modelling and optimization of flexible distributed multi-generation options, *Energy*, vol. 71, pp. 516-533, 2014.

- [15] .M. Guerrero, J. C. Vasquez, J. Matas, L. G. Vicuña, and M. Castilla, Hierarchical Control of Droop-Controlled AC and DC Microgrids—A General Approach Toward Standardization, IEEE Transactions on industrial electronics, vol. 58, pp. 158-172, 2011.
- [16] R. Ambrosio and S.E. Widergren, A framework for addressing interoperability issues, IEEE PES General Meeting, pp. 1–5., 2007.
- [17] N. Holjevac, T. Capuder and I. Kuzle, Adaptive control for evaluation of flexibility benefits in microgrid system, Energy, vol 52., pp. 487-504, 2015.
- [18] R. Jablko, C. Saniter, R. Hantisch and S. Holler, Technical and Economical Comparison of micro CHP systems, 2005 International Conference on Future Power Systems, pp. 1-6, Amsterdam, Netherlands, 2005.



### **Biography**

Ninoslav Holjevac is a PhD student at the University of Zagreb Faculty of Electrical Engineering and Computing. He is working at the Department of Energy and Power Systems as a research and teaching assistant. Professional interests include microgrid operation optimization, distribution network reliability and planning and multi energy systems.

**Publication 4 - Modelling Aspects of Flexible Multi-Energy Microgrids**

Holjevac, Ninoslav, Capuder, Tomislav; Kuzle, Igor; Zhang, Ning; Kang, Chongqing, "Modelling Aspects of Flexible Multi-Energy Microgrids", *2018 Power Systems Computation Conference (PSCC 2018)*, Dublin, Ireland, pp. 1-7, 2018.

DOI: 10.23919/PSCC.2018.8442468

- 7 pages

# Modelling Aspects of Flexible Multi-Energy Microgrids

Ninoslav Holjevac\*, Tomislav Capuder, Igor Kuzle  
Faculty of Electrical Engineering and Computing  
University of Zagreb, Zagreb, Croatia  
{ninoslav.holjevac, tomislav.capuder, igor.kuzle}@fer.hr

Ning Zhang, Chongqing Kang  
Department of Electrical Engineering  
Tsinghua University, Haidian, Beijing, China  
{ningzhang, cqkang}@tsinghua.edu.cn

**Abstract**— The paper presents a corrective receding horizon mixed integer linear programming (MILP) model of multi-energy microgrid (MEM). The operational behavior of local, aggregated generating units, renewable energy sources and customers is investigated through different modelling assumptions and multiple MEM system configurations/layouts. The results clearly show how operational points of multi-energy units, also of the MEM as a single entity, depend on modelling assumptions, in particular, those of converting device efficiencies. These approximations, often used in MEM planning models or matrix Energy Hub concepts, have negligible impact when it comes to long term analyses. However they result in significantly different flexibility indicators in short term operational time frame when compared to the more accurate models. This paper elaborates how these assumptions affect MEM behavior in market driven environment and demonstrates MEM capability to respond to intra-day disturbances caused by variability and uncertainty inherent to the production of the renewable energy sources (RES).

**Index Terms**—Multi-Energy Systems, Microgrids, Flexibility, Corrective scheduling

## I. INTRODUCTION

Integrating renewables, coordination of various load types, shift towards local energy concepts and emissions reduction goals are changing the concept of how efficient and optimal energy supply is provided [1]. Incentives and general goals of the European Union to increase the share of zero-emission generation are enabling and supporting this transition [2], [3]. Multi-energy modelling concepts provide framework for analyses beyond specific energy carrier and allow analyses and optimization of energy systems utilizing different energy vectors [4], [5], namely electricity, heating/cooling energy and fossil fuels. Exploiting synergies that might arise from interaction of different energy vectors and energy sources in district multi energy systems could unlock additional operational flexibility that is often not available when operation of only individual energy vectors is considered. These characteristics of the multi-energy systems are starting to gain recognition and entering into the focus of the academic and research societies.

Many strategic and planning concepts (including *Clean Energy for all Europeans* [6]) define future energy systems through shift in paradigm where primary supply comes from

central generation (*macrogrid*) to the concept of distributed multi-energy systems (*microgrids*) and small scale multi-generation systems [7], [8]. The grid will consist of numerous microgrids interoperating and providing solutions on the local level. This also means that a significant share of operational flexibility, alleviating issues of renewable generation integration, will come from the distribution level through integration of technologies capable of responding to different price signals. In future energy systems, characterized by more variable and more uncertain production and consumption, a desirable characteristic of multi-energy microgrid (MEM) will be its flexibility, both within the microgrid level and as a service to the upstream system, macrogrid level [9]. The renewable energy sources (RES) growing penetration increases the stochastic element related to the generation side while adding to demand fluctuations of new consumers [10], such as electric heating and electric vehicles (EV) and decrease the overall predictability of demand. This creates a challenge of efficiently integrating these low carbon technologies [11] and, at the same time, finding the optimal control that maximizes the utilization of their flexibility.

The multi-energy systems (MES) in general consist of energy storage, distribution infrastructure and the most important component, energy converters. Operational aspects of modelling different multi-energy concepts (for example Energy Hub [12], [13]) often neglect the fact that the relationship between energy input and output is not linear as efficiency tends to decrease in lower loading operation. Thus, nominal or averaged efficiency values (e.g. constant efficiency) can lead to representative models for energy conversion processes and flexibility assessment that can return inconsistent results. While these assumptions might not give incorrect values in the planning time horizon (longer-term simulations), in short-term assessment of operational flexibilities they might over-estimate (or underestimate) the available intra-day MEM flexibility to respond to market signals. As such they are manifested as significantly large differences in the exchange possibilities for a specific time steps, different exchange volume for specific time steps and, what is more important, often include different margins of operation close to minimum or maximum output power which can lead to significant cost differences. In this context, the paper provides a comprehensive analysis of these modelling

---

*This work was supported in part by the Croatian Environmental Protection and Energy Efficiency Fund under the project Microgrid Positioning (uGRIP) from the ERA Net Smart Grids Plus funding scheme and project FENISG- Flexible Energy Nodes in Low Carbon Smart Grid funded by Croatian Science Foundation under project grant No. IP 2013-11-7766.*



heating mode which is assured with following constraint on binary variables:  $H_{i,j}^{EHPbin} + C_{i,j}^{EHPbin} \leq 1$  and has a limited maximum output power. Ground source EHP have higher COP compared to smaller air-water heat pumps used in household and their COP is less variable.

2. *Combined Cooling, Heat and Power units (CCHP)*: The production of heat and power are defined for each time step  $t$  as useful energy extracted from the fuel input  $F_t^{CCHP}$  depending on thermal and electrical efficiencies parameters. These values are changing depending on the loading of the unit:  $E_t^{CCHP} = F_t^{CCHP} \cdot \eta^{echp\_e} + H_t^{binCCHP} \cdot \eta^{echp\_e'}$ . Ramping constraints limit the change of power output:  $-ramp \leq H_t^{CCHP} - H_{t-1}^{CCHP} \leq ramp$ . Startup binary logic is considered, assumed mode of operation is heat/cooling following.
3. *Micro CHP ( $\mu$ CHP)*: The  $\mu$ CHP unit output of heat and power are coupled. Set of equations is quite similar to CCHP units. The output is modelled with variable efficiency depending on loading conditions which resembles commercial units. Small, micro, units considered in this analysis (installed thermal capacity of 8 kW) have no ramping constraints relevant for time step of 15 minutes (rolling horizon simulation step advance) since they can adjust their output in under 120 seconds in full range of installed capacity.
4. *Storage*: Energy storage systems, both thermal energy storage (TES) and battery energy storage, are modeled as first-order discrete time model. This means the model accounts for the energy losses in charging and discharging processes ( $\lambda_i^{TES}$ ). Thermal storage process is defined as:  $C_i^{TES} = (1 - \lambda^{TES} / \tau) \cdot C_{i-1}^{hs} - H_i^{TES} + H_i^{CCHP\_TES}$ . Battery storage behavior is expressed as:  $C_i^{BAT} = (1 - \lambda^{BAT} \cdot \tau) \cdot C_{i-1}^{BAT} + E_i^{BAT\_ch} \cdot \eta_{BAT}^{ch} + E_i^{BAT\_dch} / \eta_{BAT}^{dch}$ . Bounds on the storage capacity and on the power exchanged with it, as well as limits on total number of daily charging and discharging cycles are also considered. Detailed explanations are provided later in the paper, focusing on two modelling cases: household level units and centralized district level units;
5. *Flexible load*: The availability of flexible response of consumers is approximated by flexible segment of total demand/appliances as percentage variable ( $p^{flex}$ ). Total amount of energy that is being “transferred” is limited at every time step ( $C_{i,j}^{flex}$ ). The response is expressed as:  $-p^{FLEX} \cdot E_{i,j}^{d-1} \leq \star E_{i,j}^{flex} \leq p^{FLEX} \cdot E_{i,j}^{d-1}$ ,  $C_{i,j}^{flex} \leq C_{i-1,j}^{flex} - E_{i,j}^{flex}$ .
6. *Chillers*: Chillers operate in-between their maximum output and minimum output. Absorption chiller uses heat to meet the cooling demand:  $Cool_i^{ABC} = H_i^{CCHP\_ABC} \cdot COP^{ABC}$ , while electric chiller uses electricity to meet the cooling demand:  $Cool_i^{EC} = E_i^{EC} \cdot COP^{EC}$ .
7. *Other units*: Other units, such as household auxiliary boiler, PV panel production, wind turbine production

units, diesel generator unit, demands (electric, heating and cooling) etc. are modelled similarly as in [14].

The variety of models available in literature deal with different aspects of multi energy modelling in different level of details. For example:

- nonlinear dependency between input fuel and output power (resembling real-world units) is the focus of research in [16], [17] while CHP unit output modelling in accordance to operational region can be found in [18];
- detailed energy storage models can be found in [19], explaining aspects of stratified model and including the more detailed physical model into the optimization;
- universal modelling of multi-energy systems using standardized matrix approach [20];
- distribution network (heating and electricity) constraints consideration [21];

None of the above papers captures all described aspects (all units), however they all attempt to elaborate on finding the optimal model by making a trade-off between sufficient precision of the results and computational burden of the algorithm. The novelty of this paper is in giving clear insight into how short and long term operational flexibility is connected with modelling assumptions and different MEM configurations.

### III. RECEDING HORIZON CORRECTIVE SCHEDULING PROBLEM FORMULATION

To clearly define different aspects of MEM flexibility in daily operation, corrective scheduling algorithm with receding horizon is developed based on model predictive control (MPC) scheme. The core of the MPC central controller is the representative mathematical model of the real system that is being controlled (in this case MEM system) which gives the desired operation of the MEM system as a result of optimization process. The system responds through the receding horizon corrective algorithm to different external signals (e.g. energy and balancing prices) and is susceptible to different sources of uncertainty (e.g. wind and solar energy production, forecast errors, demand fluctuations, etc.) and therefore adjusts its outputs over the planning horizon. Detailed description of the MPC control can be found in literature [22], [23] and [24].

Objective function of the proposed MILP algorithm is a cost minimization with a 24-hour horizon, describing day-ahead market participation of the multi-energy microgrid. The objective function, modelled by Eq. (1), consists of 3 segments which are further broken down into 3 equations for easier explanation:

1. Eq. (2) represents initial operational cost based on day-ahead prices. It gives total operational cost and MEM schedule 12 hours ahead of the delivery (through simple deterministic optimization of available resources). The resulting values are used as references for contracted exchanges of energy between MEM and the system for every half-hour of the next day (day-ahead plan). Part *I* of Eq. (2) is fossil fuel cost, part *II* is electricity exchange cost/revenue, part *III* models penalization of wind curtailment and waste of heat, *IV* and *V* are start-up and

constant costs of generation unit and diesel back-up generator while  $VI$  part are emission costs. It is worth to note that  $E_t^{imp0}, E_t^{exp0}$  mark the initial/contractual exchange plan.

2. Eq. (3) represents the mismatch cost that stems from the difference between contractual exchanges and realized exchanges. At the initial, day-ahead, optimization stage MEM made scheduling decisions based on the available information. Since these are subject to uncertainties and variabilities (such as wind and PV production) during real-time operation there will be deviations from the original schedule. MEM acts as balancing group (BG) in the market and is responsible for any and all deviations cause by its BG member. To avoid being penalized for imbalances, MEM uses “fresh” information and through the corrective scheduling redispaches its resources. In case MEM does not have inner flexibility to balance out these deviations it will have to buy them (or sell) under balancing market prices (here they are modelled as market clearing price modification factors  $M^{sell}$  and  $M^{buy}$ );
3. Eq. (4) represents the updated plan for the remaining of the daily cycle taking into account current operational points of units, updated forecasts and initial reference plan.

By defining the objective in this way the master program that emulates the MEM uncertain surrounding at every time step iteratively calls the MILP optimization of MEM operation and gains benefits over the whole planning horizon.

$$COST = \sum_{t=1}^{24\tau+1-S} \{ [\text{predicted (PRE)}] + [\text{mismatch (MIS)}] \} + \sum_{t=24\tau+1-S}^{24\tau} [\text{"updated" predicted costs (UPD)}] \quad (1)$$

$$PRE = \sum_{t=1}^{24\tau+1-S} \left( F_t^{ng} \cdot c^{ng} + F_t^{CCHP} \cdot c^f + F_t^D \cdot c^d + (E_t^{imp0} \cdot c_t^{mcp} - E_t^{exp0} \cdot c_t^{mcp}) + (P \cdot E_t^{w\_cur} + P \cdot H_t^{waste}) + (H_t^{binCCHP} \cdot c_{const}^{CCHP} + H_t^{suCCHP} \cdot c_{start}^{CCHP}) + (E_t^{bind} \cdot c_{const}^D + E_t^{suD} \cdot c_{start}^D) + (emiss_t \cdot c^{emiss}) \right) \quad (2)$$

$$MIS = \sum_{t=1}^{24\tau+1-S} \left( short_t^{imp} \cdot M^{sell} \cdot c_t^{mcp} + long_t^{imp} \cdot M^{buy} \cdot c_t^{mcp} + short_t^{exp} \cdot M^{buy} \cdot c_t^{mcp} - long_t^{exp} \cdot M^{sell} \cdot c_t^{mcp} \right) \quad (3)$$

$$UPD = \sum_{t=24\tau+1-S}^{24\tau} \left( F_t^{ng} \cdot c^{ng} + F_t^{CCHP} \cdot c^f + F_t^D \cdot c^d + E_t^{imp} \cdot c_t^{mcp} - E_t^{exp} \cdot c_t^{exp} + P \cdot E_t^{w\_cur} + P \cdot H_t^{waste} + H_t^{binCCHP} \cdot c_{const}^{CCHP} + H_t^{suCCHP} \cdot c_{start}^{CCHP} + (E_t^{bind} \cdot c_{const}^D + E_t^{suD} \cdot c_{start}^D) + emiss_t \cdot c^{emiss} \right) \quad (4)$$

As it can be seen from the illustration (Fig. 2) the initial schedule, and therefore operational costs, are realized in a certain percentage surrounding, reference costs would be equal to final realized costs. In each time step the costs is composed of several segments; segment of the daily costs associated with the realized costs in the passed time steps, incurred mismatch/balancing cost and a portion of predicted costs using the most current unit statuses and forecasts for future/unrealized time steps.

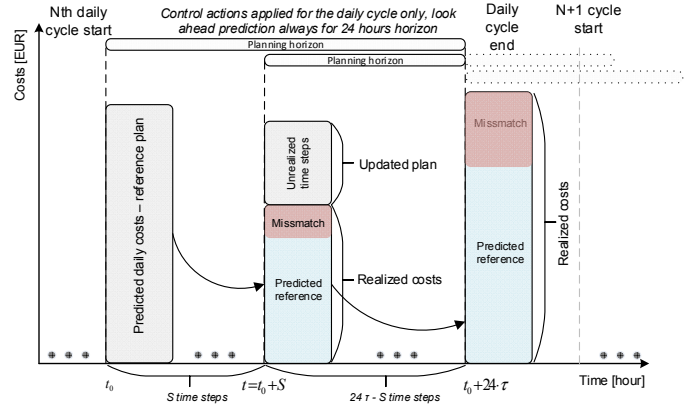

Figure 2. Illustration of the receding horizon corrective scheduling algorithm

Optimization and scheduling results of MEM system described in Section II driven by receding horizon corrective scheduling algorithm (utilizing model predictive control) are shown in the following Section IV. It is important to notice the differences in operating points as well available inner MEM flexibility depending on the level of MEM modelling details and MEM layout.

## IV. RESULTS

### A. Flexibility aspects for annual MEM operation

For both Section IV A and Section IV B, the results are shown for a series of simulations of different MEM configurations/layouts, with the main focus being on the following two configuration layouts:

*Layout 1)* entirely distributed layout with no large central units;

*Layout 2)* centralized layout where district level CCHP, EHP and storage are used.

Additional configurations are a mix of the two abovementioned layouts:

*Layout 3)* district CCHP unit with scattered household EHP units;

*Layout 4)* district level EHP with scattered household  $\mu$ CCHP units.

*Layout 5)* distributed layout with additional district level energy storage unit.

All layouts have the same installed capacity of RES (wind turbine and rooftop PV panels). Dominantly centralized layouts (Layout 2 and Layout 3) also have a backup diesel generator unit in addition to chillers for cooling energy production (absorption and electric chillers). The table below (Table II) summarizes the layout designs with all the modelled elements they include.

TABLE II. MULTI ENERGY MICROGRID SYSTEM PROPOSED LAYOUTS

Unit type	MEM layout				
	L-1	L-2	L-3	L-4	L-5
CCHP - central	-	✓	✓	-	-
μCHP - household	✓	-	-	✓	✓
EHP - central	-	✓	-	✓	-
EHP - household	✓	-	✓	-	✓
Thermal storage - central	-	✓	✓	-	✓
Thermal storage - household	✓	-	-	✓	✓
Battery storage - central	-	✓	✓	-	-
Battery storage - household	✓	-	-	✓	✓
Chillers	-	✓	✓	-	-
Backup diesel	-	✓	✓	-	-
Auxiliary boiler - household	✓	-	-	✓	✓
RES	✓	✓	✓	✓	✓

Optimization is run for an entire year period in 15 minute time steps and total costs, emissions and flexibility metric indicators (unused heating energy and curtailed wind) are analyzed and discussed. Fig. 3. depicts the values of operation indicators for different MEM system layouts.

A general conclusion arises that none of the layouts outperforms the others in all 4 metrics chosen as benchmarks. For example, Layout 1 (distributed configuration) has the highest total operation costs and emissions. This is particularly interesting when compared to centralized district Layout 2, however this conclusion is intuitive as district level units usually have higher conversion efficiency than smaller, micro units. On the other hand, Layout 1 outperforms all other layouts in terms of flexibility indicators, wasted heat or curtailed RES. The two root layouts, distributed Layout 1 and centralized district Layout 2 show the specter of results. The smaller units while providing better flexibility (accommodating higher shares of RES production with better flexibility indicators) operate with higher costs and lower efficiencies results in higher emissions. Bigger units on the other hand bigger units provide less flexibility but at lower costs and emissions. Furthermore, it is interesting to observe the relation between Layout 1 and Layout 5 (dominantly distributed layouts) which differ in the availability of additional central storage system. Benefits from adding storage system are present in form of costs and emissions reduction and increased margin for RES uncertainty compensation. The additional benefit from making the central storage available to scattered μCHP units of Layout 1 ranges around 7% for cost reduction, 11% for emissions reduction and around 2 percent for added flexibility in form of larger amount of RES production absorbed with less curtailed energy. The Layout 3 and Layout 4 provide the mix of

It is important to note that the RES production represent the amount of accommodate energy produced depending on available flexibility. The absolute total of RES production is the same for all layouts since the installed RES capacity is not changed.

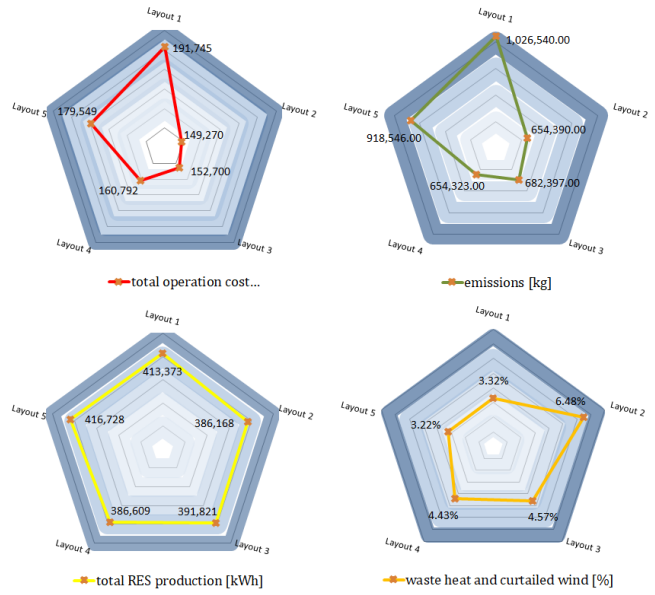

Figure 3. Operation indicators (costs, emissions, RES production and curtailment) for different MEM system configurations

In the above analyses, for all layouts, conversion efficiencies are modelled as constant values, which is a common assumption in many models (e.g [25], [26]). However, such modelling approaches might over or underestimate realistically available flexibility of MEM. To quantify this, results of both modelling approaches (constant efficiency approximation and realistic loading dependent efficiency values) of MEM Layout 2 are shown in Table III. It can be argued that operational cost differences of around 5% might be acceptable for planning purposes, however this was further used as an indicator that sever differences in operating points depending on the modelling approach might have high impact in daily operation planning.

TABLE III. COMPARISSON BETWEEN TWO MODES OF EFFICIENCY MODELLING

Operation indicator	MEM Layout 2 - constant efficiency	MEM Layout 2 - variable efficiency	$\Delta$ [%]
Total cost [EUR]	193,340.00	204,892.00	5.97
Emissions CO <sub>2</sub> [kg]	713,954.00	900,388.00	26.11
RES production [kWh]	389,389.00	410,885.00	5.52
Curtailment [kW] <sup>a</sup>	89,401.20	84,165.00	-5.86

a. Percent of total energy produced

An additional interesting aspect that can be noticed when looking at the operating points is that in average lower efficiency of EHP and CCHP units (in loading dependent



efficiency modelling) manifests more flexible response to fluctuations compared to higher efficiency units consequently, having different signals on the available flexibility. For example, a surplus of electricity produced by CCHP unit (which is lower at a lower efficiencies) is needed to be used in a larger portion in household EHP units of a lower efficiency to achieve the same result as when using more efficient units.

### B. Flexibility aspects for daily MEM operation

Results shown in Table III suggest that modelling operation by approximating unit conversion efficiency with constant values will result in incorrect knowledge of real-time operational points of MEM units and, consequently, give incorrect estimates of available inner flexibility of MEM [27]. To analyze the impact of these modelling approximations and their value for additional available operational flexibility [28], [29] several daily simulations are cast by corrective receding horizon MILP algorithm described in Section 2. The importance of correct knowledge of available inner MEM flexibility is manifested through the need of redispatching MEM units due to variability and uncertainty caused by imprecise forecasts on a day ahead market. To mitigate these forecast imprecisions by corrective optimization, central MEM controller should have the correct knowledge of the available unit flexibility to properly position itself at the intra-day market and buy/sell the remaining needed energy.

When the operational points of units in every time step are observed for different modelling of efficiency (Fig. 4.) it can be seen that available flexibility range (upward and downward) is significantly different. The upward range is defined as current operation point plus the ramp-up change of output up to a max power limit. Similarly, downward range are operational point the unit can reach in next simulation step limited by the ramp-down and capped by minimum output power.

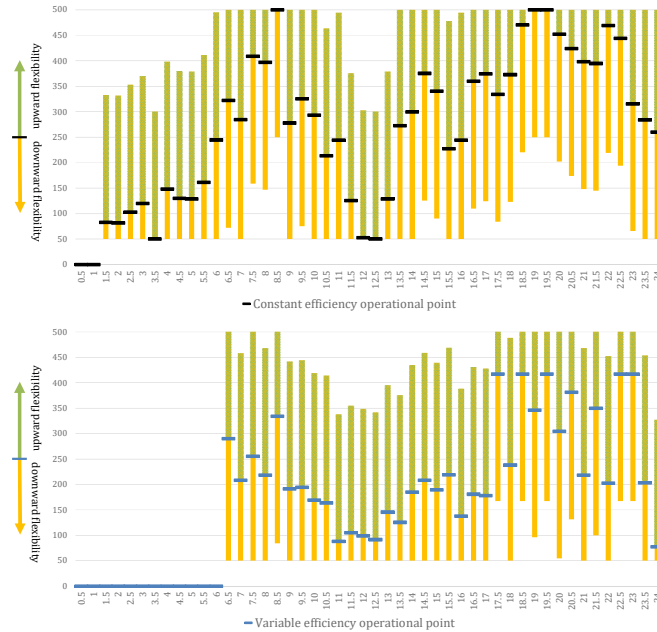

Figure 4. Available flexibility depending on the efficiency model used (constant versus variable efficiency); MEM layout 2

Difference in start-up times (unit is offline for first 6 hours in variable efficiency simulation) to the difference in available flexibility amounts (interconnected with difference in operational point) can be observed which can lead to unprecise information about the real status and capabilities of units.

When the value of applying corrective algorithm is evaluated it is important to understand the operational aspects of such receding horizon algorithm. As shown in Fig. 2. the algorithm always looks ahead and applies corrective actions when needed. It always considers the initial/contractual plan of exchanges but searches to optimize the costs and environmental impact. The change of planned operational points throughout the whole horizon as the time progresses in the daily cycle is depicted on figure below (Fig. 5.). For the depicted scenario (a typical winter day) it can be seen that the algorithm adjusts the operation and changes the plans significantly.

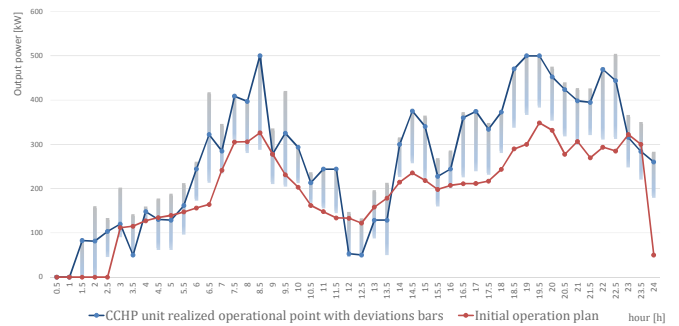

Figure 5. The operational point of the generation unit (CCHP) throughout the whole daily cycle (with deviation range bars) compared to the initial operation plan based on the reference run

Additionally, in the later stages of the day (towards the end of the daily cycle) adjustments of the receding horizon corrective algorithm are in average of greater magnitude compared to the earlier stages and in average towards the end of the planning horizon the difference compared to the initial operation plan are greater. This is interrelated with the nature of the prediction that is usually done more than 24 hours ahead of the plan realization and that in average is less accurate the more distant is the plan of realization.

As was shown through simulation results this paper provides the theoretical background and simulation results of the presented control and optimization framework. The practical implementation and use is possible and in real operation similar savings and improvements could be obtained. Preliminary requirements list show that with current communication infrastructure all prerequisites are met. Additionally, computation burden is not a constraining factor since each simulation cycle concludes within seconds range. Therefore, the implementation of a modified version of model predictive guided control is planned to be implemented on the real test site of the laboratory microgrid network that will incorporate all the relevant units.

## V. CONCLUSION

The paper develops a multi-energy microgrid optimization model that incorporates flows of different energy vectors:

heating, cooling, electricity and fossil fuel. Through annual and daily optimization horizon it evaluates the operation of different MEM configurations in uncertain surroundings through different flexibility indicators (e.g. mismatch from day-ahead contractual electricity import/export). It clearly shows how different MEM layouts behave in terms of the financial (costs) and environmental (emissions) aspects and from the operational aspect (flexibility) and demonstrated that none of the analyzed layouts (different combinations of centralized and decentralized multi-energy units and RES) outperforms others in all selected benchmarking metrics. It further analyzes the impact of efficiency modeling (constant efficiency vs. variable efficiency depending on loading) through annual and, more importantly, daily operation of the MEM system governed by the receding horizon corrective scheduling algorithm. A simple version of the flexibility map is given for MEM that in every moment gives information how much flexibility can be provided and points to moments where extra cost are induced. These results show distinctive importance of efficiency modelling for the flexibility analysis. Furthermore, the way the receding horizon scheduling algorithm operates was described and the amounts of adjustments were presented.

To obtain even more precise results the non-linear and more detailed model for the efficiency of all units could be incorporated as well as network physical constraints (power and heat flow equations). This could provide unsurpassed level of detail but the computational efficiency and the added value of these extra levels of details need to be investigated.

#### REFERENCES

- [1] S. Clegg and P. Mancarella, Integrated Electrical and Gas Network Flexibility Assessment in Low-Carbon Multi-Energy Systems, *IEEE Transactions on Sustainable Energy*, vol. 7, no. 2, pp. 718-731, 2016.
- [2] P. Siano, Assessing the Impact of Incentive Regulation for Innovation on RES Integration, *IEEE Transactions on Power Systems*, vol. 29, pp. 2499–2508, 2014.
- [3] D.F. Dominković, I. Bačeković, B. Čosić, G. Krajačić, T. Pukšec, N. Duić and N. Markovska, Zero carbon energy system of South East Europe in 2050, *Applied Energy*, vol. 184, pp. 1517-1528, 2016.
- [4] P. Mancarella, MES (multi-energy systems): an overview of concepts and evaluation models. *Energy*, vol. 65, pp. 1–17, 2014.
- [5] M. Qadrdan, M. Cheng, J. Wu, et al. Benefits of demand-side response in combined gas and electricity networks. *Applied Energy*, vol 192, pp. 360-369, 2017.
- [6] Clean Energy for All Europeans, European Commission, Brussels, 30<sup>th</sup> Nov 2016. , available online (accessed 06<sup>th</sup> Mar 2018) - <https://ec.europa.eu/energy/en/topics/energy-strategy-and-energy-union/clean-energy-all-europeans>
- [7] G. Chicco and P. Mancarella, Matrix Modelling of Small-scale Trigenation Systems and Application to Operational Optimization”, *Energy*, vol. 34, pp. 261–273, 2009.
- [8] T. Capuder and P. Mancarella, Techno-economic and Environmental Modelling and Optimization of Flexible Distributed Multi-Generation Options, *Energy*, vol. 71, pp. 516-533, 2014.
- [9] T. Capuder and P. Mancarella, “Assessing the Benefits of Coordinated Operation of Aggregated Distributed Multi-Energy Generation,” in *Power System Computation Conference (PSCC) 2016*, pp. 1–7, 2016.
- [10] Y. Wang, N. Zhang, Q. Chen, D. S. Kirschen, P. Li and Q. Xia, "Data-Driven Probabilistic Net Load Forecasting with High Penetration of Invisible PV," *IEEE Transactions on Power Systems*, vol. PP, no. 99, in press, 2017.
- [11] B Morvaj, R Evins, J Carmeliet, Comparison of individual and microgrid approaches for a distributed multi energy system with different renewable shares in the grid electricity supply, *Energy Procedia*, vol. 122, pp. 349-354, 2017.
- [12] T. Krause, G. Andersson, K. Frohlich, et al. A general model for energy hub economic dispatch. *Applied Energy*, vol 190, pp. 1090-1110, 2017.
- [13] Y. Wang, N. Zhang, Z. Zhou, C. Kang, D. Kirschen, Mixed-integer linear programming-based optimal configuration planning for energy hub: Starting from scratch, *Applied Energy*, in press, 2017.
- [14] N. Holjevac, T. Capuder, N. Zhang, I. Kuzle and C. Kang, Corrective receding horizon scheduling of flexible distributed multi-energy microgrids, *Applied Energy*, vol. 207, pp. 176-194 2017.
- [15] N. Holjevac, T. Capuder and I. Kuzle, Defining Key Parameters of Economic and Environmentally Efficient Residential Microgrid Operation, *Energy Procedia*, vol. 105C, pp. 999-1008, 2017.
- [16] N. Good, P. Mancarella, Flexibility in multi-energy communities with electrical and thermal storage: A stochastic, robust approach for multi-service demand response, *IEEE Transactions on Smart Grid*, Vol. PP, Issue: 99, pp. 1-1, 2017.
- [17] A. Parisio, C. Wiezorek, T. Kyntaja, J. Elo, K. Strunz and K. H. Johansson, Cooperative MPC-based Energy Management for Networked Microgrids, *IEEE Transactions on Smart Grid*, Volume: PP, Issue: 99, 2017.
- [18] X. Chen, C. Kang, M. O'Malley and Q. Xia. Increasing the flexibility of combined heat and power for wind power integration in China: modeling and implications. *IEEE Trans Power Syst.* 2015; 30(4), pp.1848–1857
- [19] T. Schütz, H. Harb, R. Streblov, D. Müller, Comparison of models for thermal energy storage units and heat pumps in mixed integer linear programming, *The 28th international conference on Efficiency, Cost, Optimization, Simulation and Environmental Impact of Energy Systems*, 2015.
- [20] Y. Wang, N. Zhang, C. Kang, D. S. Kirschen, J. Yang and Q. Xia, Standardized Matrix Modeling of Multiple Energy Systems, *IEEE Transactions on Smart Grid*, vol. PP, no. 99, pp. 1-1, 2017.
- [21] B Morvaj, R Evins, J Carmeliet, Optimising urban energy systems: Simultaneous system sizing, operation and district heating network layout, *Energy*, vol 116, pp. 619-636, 2016
- [22] N. Holjevac, T. Capuder and I. Kuzle, Adaptive control for evaluation of flexibility benefits in microgrid system, *Energy*, vol 52, pp. 487-504, 2015.
- [23] I. Kuzle, N. Holjevac and T. Capuder, Model predictive control for scheduling of flexible microgrid systems, *9th Conference on Sustainable Development of Energy, Water and Environment Systems-SDEWES*, pp. 473-494A, 2014.
- [24] V. Lešić, A. Martinčević, M. Vašak, Modular energy cost optimization for buildings with integrated microgrid, *Applied Energy*, Vol. 197, pp. 14-28, 2017
- [25] V. Verda, F. Colella, Primary energy savings through thermal storage in district heating networks, *Energy*, vol. 36, pp. 4278–4286., 2011.
- [26] G. Papaefthymiou, B. Hasche, C. Nabe, Potential of Heat Pumps for Demand Side Management and Wind Power Integration in the German Electricity Market, *IEEE Trans. Sustain. Energy*, vol. 3, pp. 636–642, 2012.
- [27] S. Sučić and T. Capuder, Automation of flexible distributed multi- generation systems by utilizing optimized middleware platform, *Applied energy*, vol 169, pp. 542-554, 2016.
- [28] P. Mancarella and G. Chicco, "Integrated energy and ancillary services provision in multi-energy systems," *2013 IREP Symposium Bulk Power System Dynamics and Control - IX Optimization, Security and Control of the Emerging Power Grid*, Rethymno, pp. 1-19., 2013.
- [29] P. Mancarella, G. Chicco, T. Capuder, “Assessing distributed multi-energy system capability to provide power system services”, *SDEWES 2017*, pp. 1-14, 2017.

**Publication 5 - Model for Defining the Potential and Value of Multi-Energy Microgrid Services to the Low Carbon Power System**

Holjevac, Ninoslav, Capuder, Tomislav; Kuzle, Igor. "Model for Defining the Potential and Value of Multi-Energy Microgrid Services to the Low Carbon Power System Operation", *11th Mediterranean Conference on Power Generation, Transmission, Distribution and Energy Conversion (MEDPOWER 2018)*, Dubrovnik, Croatia, pp. 1-6, 2018.

- 6 pages

# Model for Defining the Potential and Value of Multi-Energy Microgrid Services to the Low Carbon Power System Operation

Ninoslav Holjevac<sup>1\*</sup>, Tomislav Capuder<sup>1</sup>, Igor Kuzle<sup>1</sup>

<sup>1</sup>University of Zagreb Faculty of Electrical Engineering and Computing, Unska 3, 10000 Zagreb, Croatia  
\*ninoslav.holjevac@fer.hr

**Keywords:** multi-energy systems, bi-level modelling, mixed-integer programming

## Abstract

Multi-energy system and more specifically, multi-energy microgrids (MEM) are expected to have a significant role in the future, low-carbon power systems. Their ability to provide both services to its customers and to the upstream system by means of local integration of distributed energy resources, provision of aggregation and energy storage services is very valuable. In this paper a bi-level approach to modelling is presented to inspect the behaviour of multi-energy microgrid that are interconnected with the upstream system through the exchange of prices signals. The MEM is defined as a market participant that can trade the energy. The energy trading and settlement is done in the upper level of the model where the energy prices are defined. In the lower level of the problem the MEM daily optimal scheduling of resources is done considering the dependent decision of the connection to the upper level. With the usage of duality theorem, the bi-level problem is converted into the single level problem that can be solved with available solver. The proposed model has been demonstrated on the simple illustrative example and the numerical results obtained show the validity of such approach.

## 1 Nomenclature

### 1) Sets and indices

$t, n, g, b, l$	hours indices from set $T$ buses indices from set $N$ generators indices from set $G$ generator offer blocks from set $B$ lines indices from set $L$
$p, m, d, s, h$	Load indices from set $P$ microgrid indices from set $M$ indices from set $N$ aggregates indices from set $D$ RES source indices from set $S$ battery indices from set $H$
2) Inputs	
$sus_l$	Susceptance of line $l$
$pf_l^{\max}$	Line $l$ transmission capacity [MW]
$\lambda_{g,b}^G$	Generator $g$ production block $b$ price on bus $n$ [EUR/MW]
$\lambda_n^P$	Load price on bus $n$ [EUR/MW]
$g_{g,b}^{\max}$	Generator block max production [MW]
$p_p^{\max}$	Load on bus $n$ [MW]
$\lambda^d, \lambda^{start}, \lambda^c$	Aggregate $d$ variable, fixed and startup costs [EUR/kW], [EUR]
$p_d^{\max}, p_d^{\min}$	Aggregate min and max power [kW]
$D(t)$	Microgrid demand in hour $t$ [kW]

$\lambda^G(t),$	Purchase price, selling price: (dual $\alpha_n(t)$ ) [EUR/kWh]
$\lambda^D(t)$	
$\eta_h^{dis}, \eta_h^{ch}$	Discharge and charge efficiency of battery unit $h$ [%]
$soc_h^{\max}$	Battery capacity [kWh]
$ch_h^{\max}, dis_h^{\max}$	Battery $h$ max and min charge and discharge capacity [kWh]
$S_s(t)$	RES production at time $t$ [kW]
3) Variables	
$x_h^{ch}(t), x_h^{dis}(t)$	Charging state binaries
$q_h^{ch}(t), q_h^{dis}(t)$	Charging/discharging power of a battery $h$ in an hour $t$ [kW]
$y_d(t), x_d(t)$	Diesel aggregate binary variable
$soc_h(t)$	State of charge of battery $h$
$q_m^k(t), q_m^p(t)$	Microgrid $m$ bought/sold energy [MWh]
$x_m^k(t), x_m^p(t)$	Microgrid import/export binaries
$P_s^i(t)$	RES source $s$ used energy in hour $t$ [MW]
$P_d(t)$	Aggregate $d$ production in hour $t$ [MW]
$P_p(t)$	Microgrid demand covered in hour $t$ [MW]
$g_{g,b}(t)$	Generator $g$ block $b$ production [MW]
$pf_l(t)$	Transmitted power through line $l$ [MW]
$\theta_n(t), \theta_r(t)$	Busbar power angle, reference busbar [rad]

## 2. Introduction

### 2.1 Motivation

In the modern world the consumers are accustomed to a high availability and standard of the energy services. The electrical energy specifically is integrated into all aspect of everyday activities. The power system that is responsible for the delivery of different energy vectors needs to maintain the balance even under the growing uncertainty circumstances [1]. The distributed resources while providing great opportunities also present obstacles for the everyday operation. With the liberalization of the power and energy sectors the operation becomes even more profit driven and through the development of new concepts and technologies new participants get the chance to take part in the energy markets. One of those potential new players are microgrids, more specifically multi-energy microgrids (MEM) [2] that are distributed locally and are directly linked and made of different customer-level entities. The advantage of such microgrids is their coupling of different energy carriers (e.g. heat and electricity). This inherently means the energy converters and energy storages to change energy patters are also present. The flexibility of MEM to swap energy usage between carriers provides a great opportunity. Therefore, with the increasing competition in the power market sector it is important to enhance the rates of participation of such MEM entities and increase their potential interaction with the system. To this aim this paper presents a model that considers the participation of a multi-energy microgrid in the daily operation power system as whole.

### 2.2 Motivation

In the modern world the consumers are accustomed to a high availability and standard of the energy vectors delivered to them in the surrounding dominated with the growing increase in renewable energy sources (RES) shares. As such, multi-energy systems (MES), more specifically MEM, can help accommodate more renewable energy and can increase the utilization efficiency of primary energy sources, renewable energy sources included [3]. The multi-energy systems can locally integrate larger numbers of smaller production units and consumers. This means their impact on the market interactions will be increased. Depending on the influence single, or multiple multi-energy entities have on the marker interactions there is a need to investigate the optimal participation of all the entities. The layer structure can be defined:

- the first layer is presented with different energy converters (micro combined heat and power plants ( $\mu$ CHP, energy storage etc.) and consumers;
- the second layer presenting their integration into a multi-energy system (e.g. MEM) through the local energy network;
- the third layer being the integration of multiple multi-energy systems;
- the final layer is presented through the marker where all the players optimize their profit in a competitive environment.

The model described here considers two layers of the problem, the internal multi-energy system operation and external market participation. The multi-energy system is interacting with the market with the goal of maximizing the profit. The objective function of the market structure is to maximize the social welfare through the minimization of the energy procurement costs. The multi-energy system determines its daily energy production and balance based on the energy prices on which it can (“price maker”) od cannot (“price taker”) have influence. The interaction between two levels of the problem through the market price signal creates the non-linearity. The bi-level problem is transformed into a single level mathematical program with equilibrium constraints (MPEC) through the means of the duality theorem. This creates a single stage mixed integer linear program (MILP) that can be solved using the available solvers.

### 2.3 State-of-the-art and literature overview

The idea of integral modelling of the multi-energy systems stems from the energy hub framework [4] approach to model the energy vectors flows inside the described nodes that consist of energy carriers, energy converters and energy storage utilizing the optimization problem to guarantee the optimal result [5]. Several other works have dealt with finding the solution for the optimal power flows of the interconnected energy vectors of the multi-energy systems. In [6] the industrial hub was modelled, while the optimal power flows in the residential community level microgrid are investigated in [7] and [8] investigating different aspect of the multi-energy microgrids modelling. Additionally, the matrix modelling structure approach has been successfully applied in [9]. Many authors of the literature in the field propose different approaches to mitigate the intermittency of the renewable energy sources by means of unlocking the inherent flexibility of the coupled optimization of different energy vectors. In [10] the multi agent approach has been applied while in [11] multilayer approach was used to model the interaction between the market players and in [12] MILP model was used to investigate different modelling aspects of multi-energy microgrids. In [13] similar bi-level modelling approach was used for different investment and longer-term analyses.

### 2.4 Paper contributions and structure

In short, the paper contribution can be expressed as stated in the following bullets:

- Modelling of the decision-making process of the multi-energy system through the proposed bi-level structure model.
- Transformation of the nonlinear bi-level problem by means of the duality theorem into a single level optimization problem.

The layout of the paper is as follows. In Section 3, modelled system with its constraints is described. The dual format of proposed bi-level problem and transformation procedure for transforming the problem into a single level problem that can be solved with commercial solvers is given in Section 4. In

Section 5 illustrative case study results are given. Finally concluding remarks are presented in Section 6.

### 3 Multi-energy system modelling

In this paper, as was mentioned in the introduction, the problem of the interaction between two levels of the market participants is modelled. Figure below (Fig. 1) depicts the structure of the formulated bi-level problem. The upper level problem segment deals with the optimization of the daily operational plan of the multi-energy microgrid system while the lower level of the proposed bi-level model represents the market model with the daily clearing process and formulation of the energy prices.

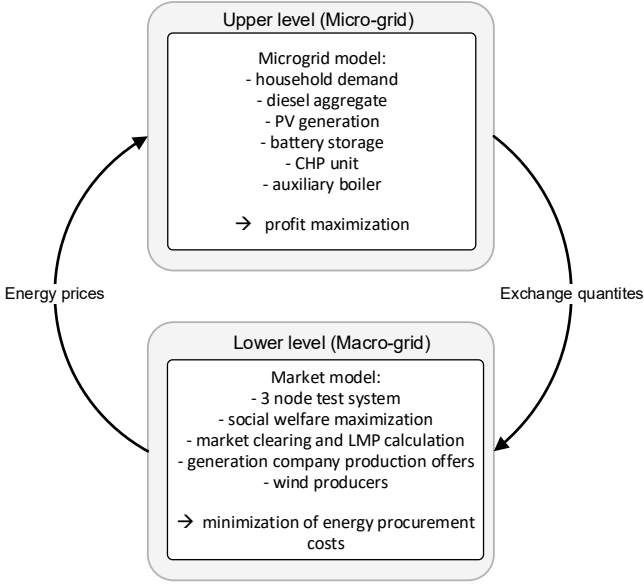

Fig. 1 General structure of the proposed bi-level problem: “microgrid” – upper level problem and “macrogrid” – lower level problem

The MEM is defined as a market participant that can trade the energy. The energy trading and settlement is done in the lower level of the model where the energy prices are defined. In the upper level of the problem the MEM daily optimal scheduling of resources is done considering the dependent decision of the connection to the upper level. With the usage of duality theorem, the bi-level problem is converted into the single level problem that can be solved with available solver.

Simplified multi-energy model compared to the one used in previous work of authors [14] was modelled in the upper level. It consists of production unit, renewable energy sources generation, loads and energy storage (Fig. 2). The optimization model simulates the optimal operational positioning of the multi-energy system over a 24-hour period that can through the point of common coupling (PCC) bi-directionally exchange the energy (import/export). Simultaneously, it simulates the market clearing and price formulation process in the lower level. It defines the market price for each 24-hour segment and considers the local marginal prices. It assumes a DC power flow formulation that does not regard the reactive power flows and power losses. The DC power flows have satisfactory precision for the

proposed modelling approach and are linear which is convenient for the solving process. The case study presented consists of 3 bus illustrative system (Fig. 2) with the multi-energy microgrid being connected to bus 2.

#### 3.1 Upper level problem (microgrid)

The objective function of the multi-energy microgrid is profit maximization. The exchange and communications with the rest of the system is expressed through the marginal price  $\alpha_n(t)$  multiplied by the exported or imported quantities ( $q_m^k(t), q_m^p(t)$ ). The microgrid optimally positions its operation over a 24-hour horizon, minimizes the operation costs of the auxiliary aggregates while satisfying the demand (Eq.(1)).

$$PROFIT = \max \sum_{t=1}^T \left[ \alpha_n(t) \cdot (P_{imp}^m(t) - P_{exp}^m(t)) + \sum_{d=1}^D \lambda^d \cdot P_d(t) + \lambda^{start} \cdot y_{d\_start}(t) + \lambda^c \cdot y_d(t) \right] \quad (1)$$

In the energy equilibrium equation (Eq. (2)) the battery energy storage, auxiliary aggregates, RES production and demand are included.

$$P_s^i(t) + P_d(t) + q_h^{dis}(t) + q_m^k(t) = D_m(t) + q_m^p(t) + q_h^{ch}(t) \quad \forall t \in T \quad (2)$$

The upper objective function is solved with respect to the following microgrid components constraints ((3)-(6)).

The battery state of charge ((3), regulation of its simultaneous charging and discharging and maximum charging power (4) are defined as following:

$$soc_h(t) = soc_h(t-1) + q_h^{ch}(t) \cdot \eta_h^{ch} - \frac{q_h^{dis}(t)}{\eta_h^{dis}} \quad \forall h \in H, \forall t \in T \quad (3)$$

$$\left[ \begin{array}{l} 0 \leq soc_h(t) \leq soc_h^{\max} \\ x_h^{ch}(t) + x_h^{dis}(t) \leq 1 \\ q_h^{dis}(t) \leq dis_h^{\max} \cdot x_h^{dis}(t) \\ q_h^{ch}(t) \leq ch_h^{\max} \cdot x_h^{ch}(t) \\ q_h^{dis}(t), q_h^{ch}(t) \geq 0 \end{array} \right] \quad \forall h \in H, \forall t \in T \quad (4)$$

The RES available production must be lower than the available resource:

$$P_s^i(t) \leq P_s^{\max}(t) \quad \forall s \in S, \forall t \in T \quad (5)$$

Auxiliary aggregate has its operational limits and binary logic defined as following:

$$\left[ \begin{array}{l} P_d(t) \leq P_d^{\max} \cdot x_d(t) \\ P_d(t) \geq P_d^{\min} \cdot x_d(t) \\ y_d(t) = x_d(t) - x_d(t-1) \end{array} \right] \quad \forall d \in D, \forall t \in T \quad (6)$$

The exchange can in each hour be either import or export which is assured with the following constraint:

$$\left[ x_m^k(t) + x_m^p(t) \leq 1 \right] \quad \forall m \in M, \forall t \in T \quad (7)$$

#### 3.2 Lower level problem (macrogrid)

The lower level objective function represents the power system flows and market clearing process. The objective is to maximize the social welfare (8).

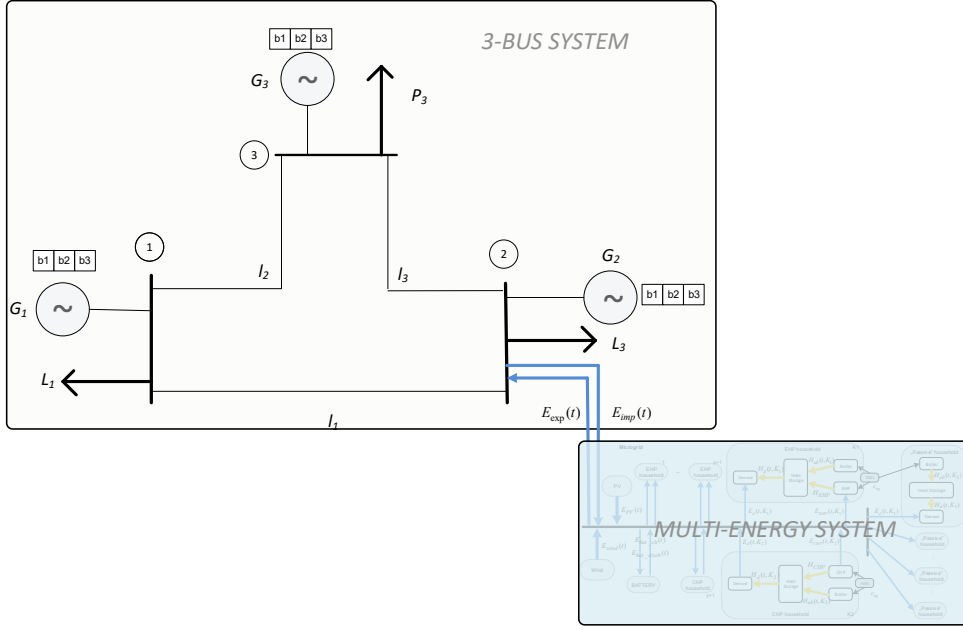

Fig. 2 Modelled illustrative example including the upper level (MEM) and lower level (3-bus system) problems

$$SOCIAL\_WELFARE = \left\{ \begin{array}{l} \max \sum_{n \in N} \sum_{p \in P} \lambda_n^p \cdot p_p(t) + \sum_{m \in M^n} q_m^k(t) \cdot 100 - \\ \sum_{b \in B} \sum_{g \in G} \lambda_b^g \cdot g_{g,b}(t) - \sum_{m \in M^n} q_m^e(t) \cdot 0 \end{array} \right\} \quad (8)$$

The microgrid export and import modifiers ensure that the microgrid when it has surplus available to be sold wants to participate and sell (bids the lowest price) and when it needs to import energy to satisfy the demand it bids the high price to ensure all the customers' needs are satisfied.

The lower level problem is transformed through its dual to allow the solving.

Local marginal prices equation:

$$\sum_{l \in L^n} pf_l(t) + \sum_{b \in B} \sum_{g \in G} \lambda_b^g \cdot g_{g,b}(t) + \sum_{m \in M^n} q_m^p(t) = \sum_{n \in N} \sum_{p \in P} p_p(t) + \sum_{m \in M^n} q_m^k(t) : \alpha_n(t) \quad \forall n \in N \quad (9)$$

Set of equations (10) represents the constraints of transmission lines with corresponding dual variables listed.

$$\left[ \begin{array}{l} pf_l(t) = sus_l \cdot (\theta_s - \theta_m) \quad : \beta_l(t) \\ pf_l(t) \leq pf_l^{\max} \quad : \gamma_l(t) \\ y_d(t) = x_d(t) - x_d(t-1) \quad : \delta_l(t) \end{array} \right] \quad \forall l \in L \quad (10)$$

Generator production blocks are limited with max capacity (11).

$$g_{g,b}(t) \leq g_{g,b}^{\max} \quad : \mu_{g,b}(t) \quad \forall b \in B, \forall g \in G \quad (11)$$

Microgrid exchange limits are defined with equation set:

$$\left[ \begin{array}{l} q_m^k(t) \leq x_g^k(t) \cdot K \quad : \varphi_m^k(t) \\ q_m^p(t) \leq x_g^p(t) \cdot K \quad : \varphi_m^p(t) \end{array} \right] \quad \forall m \in M \quad (12)$$

The power angle limits on the system buses and the reference busbar are set with the equation set (13).

$$\left[ \begin{array}{l} -\pi \leq \theta_n(t) \leq \pi \quad : \eta_n^{\max}(t), \eta_n^{\min}(t) \\ \theta_n(t) = 0 \quad : z(t) \text{ reference bus} \end{array} \right] \quad \forall n \in N \quad (13)$$

Exchange quantities are positive variables, demand is a positive variable, transmission line power is unlimited variable (can be plus or minus depending on the flow direction) and the power angle is also unlimited variable.

### 3.3 Dual of the lower level problem

The equivalent dual problem consists of primal constraints, dual constraints and final duality equation [15]. In accordance to the duality theory [16] new objective function (14) is obtained with the constraints (15)-(18).

$$SW = \min \left\{ \begin{array}{l} \sum_{l \in L} pf_l^{\max} \cdot \gamma_l(t) - \sum_{l \in L} pf_l^{\max} \cdot \delta_l(t) + \sum_{m \in M^n} \mu_{g,b}(t) \cdot g_{g,b}^{\max} \\ + \sum_{n \in N} \left[ \pi \cdot (\eta_n^{\max}(t) - \eta_n^{\min}(t)) + \sum_{g \in G} \kappa_p(t) \cdot d_n^{\max} \right] \\ + \sum_{m \in M} K \cdot \left[ \varphi_m^k(t) \cdot x_m^k(t) + \varphi_m^p(t) \cdot x_m^p(t) \right] \end{array} \right\} \quad (14)$$

Generator (15), consumption (16), lines (17) constraints sets:

$$\sum_{g|o(g)=n} \alpha_n(t) + \mu_{g,b}(t) \geq \sum_{b \in B} -\lambda_{g,b}^G \quad \forall g \in G, \forall b \in B \quad (15)$$

$$\sum_{p|o(p)=n} \alpha_n(t) + \kappa_p(t) \geq \sum_{n \in N} \lambda_n^P \quad \forall n \in N, \forall p \in P \quad (16)$$

$$\left[ \begin{array}{l} \sum_{l|o(l)=n} \alpha_n(t) + \beta_l(t) + \gamma_l(t) + \delta_l(t) = 0 \quad \forall l \in L \\ - \sum_{l|o(l)=n} sus_l \cdot \beta_l(t) + \eta_n^{\max}(t) + \eta_n^{\min}(t) = 0 \quad \forall n \in N \\ - \sum_{l|o(l)=n} sus_l \cdot \beta_l(t) + z(t) = 0 \quad n = \text{reference bus} \end{array} \right] \quad (17)$$

Microgrid exchange constraints set (18):

$$\begin{aligned}
& - \sum_{m|o(m)=n} \alpha_n(t) + \phi_n^k(t) \leq 100 \quad \forall m \in M \\
& - \sum_{m|o(m)=n} \alpha_n(t) + \phi_n^p(t) \leq 0 \quad \forall m \in M
\end{aligned} \tag{18}$$

Final equivalent objective function of the lower level model is expressed as in (19).

$$\left. \begin{aligned}
& \sum_{n \in N} \sum_{p \in P} \lambda_n^p \cdot p_p(t) + \sum_{m \in M^n} q_m^k(t) \cdot 100 - \\
& \sum_{b \in B} \sum_{g \in G} \lambda_b^g \cdot g_{g,b}(t) - \sum_{m \in M^n} q_m^e(t) \cdot 0 \\
& = \sum_{l \in L} p_l^{\max} \cdot \gamma_l(t) - \sum_{l \in L} p_l^{\max} \cdot \delta_l(t) + \sum_{m \in M^n} \mu_{g,b}(t) \cdot g_{g,b}^{\max} \\
& + \sum_{n \in N} \left[ \pi \cdot (\eta_n^{\max}(t) - \eta_n^{\min}(t)) + \sum_{g \in G} \kappa_p(t) \cdot d_n^{\max} \right] \\
& + \sum_{m \in M} K \cdot \left[ \phi_m^k(t) \cdot x_m^k(t) + \phi_m^p(t) \cdot x_m^p(t) \right]
\end{aligned} \right\} \tag{19}$$

### 3.4 Linearization

This MILP model is not linear, but it can be linearized similarly as shown in [13] and in [15]. It is done using the KKT (Karush-Kuhn-Tucker) conditions with the Lagrange multipliers.

## 4 Results

The proposed model has been demonstrated on the simple illustrative example and the numerical results obtained show the validity of such approach. Bilevel optimization model for microgrid participation as a price influential entity showed that there is an importance in allowing such new market entities to participate. In the described approach the microgrid was the only player that was reacting to the market situation and had the information about other influential participants. In reality it can be assumed this problem to be a cooperative game in which the tendency is to reduce the overall procurement costs.

In general, the microgrid can influence the prices (Fig. 3) particularly in periods of the day when there is not enough local RES production.

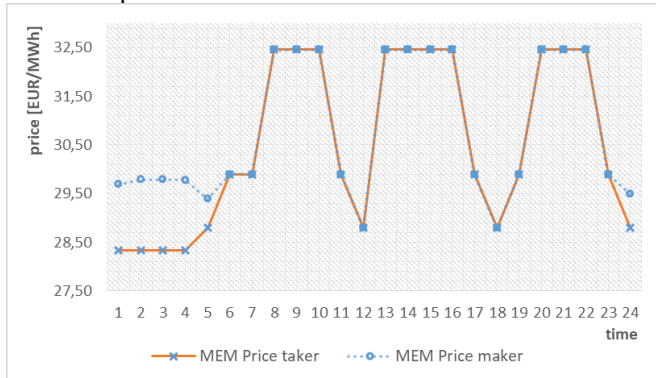

Fig. 3 Electricity prices for each 24-hour period depending on the MEM participation on the energy market

As was explained in the section 3 the microgrid in hours when it requires energy to be bought from the market

positions itself in high-price ranges to ensure the covering of all the demand. This can lead to the clearing process to find the intersection between the offer curves and demand curves in a little higher prices range. On the other hand since microgrid is maximizing its profit it will not reduce the electricity price since that would lead to reduction of its profit.

## 5 Conclusion

The paper presented the bi-level model with the multi-energy system/microgrid optimization of profit being the upper level problem and the market clearing and market participation being the lower level problem. The initial mathematical model was transformed into the mathematical problem with equilibrium constraints. Results reveal an interconnected effect of local and wholesale equilibrium prices with the increasing share of the multi-energy systems participating.

## 6 Acknowledgements

This work has been supported by Croatian Science Foundation and Croatian TSO (HOPS) under the project Smart Integration of RENEwables - SIREN (I-2583-2015) and is a part of the H2020 project CROSSBOW-CROSS BOrder management of variable renewable energies and storage units enabling a transnational Wholesale market (Grant No. 773430). This document has been produced with the financial assistance of the European Union. The contents of this document are the sole responsibility of authors and can under no circumstances be regarded as reflecting the position of the European Union.

## 7 References

- [1] Moreno R, Street A, Arroyo JM, Mancarella P. "Planning low-carbon electricity systems under uncertainty considering operational flexibility and smart grid technologies", *Phil. Trans. R. Soc.*, vol. 375: 20160305, 2017.
- [2] P. Mancarella, "MES (multi-energy systems): AN overview of concepts and evaluation models," *Energy*, vol 65, pp. 1-17, 2014.
- [3] T. Capuder, P. Mancarella, "Techno-economic and environmental modelling and optimization of flexible multi-generation options," *Energy*, vol. 71, pp. 516-533, 2014.
- [4] M. Geidl, G. Koeppl, P. Favre-Perrod, B. Klockl, G. Andersson, and K. Frohlich, "Energy hubs for the future," *IEEE Power and Energy Magazine*, vol. 5, pp. 24-30, 2007.
- [5] M. Geidl and G. Andersson, "Optimal Power Flow of Multiple Energy Carriers," *IEEE Transactions on Power Systems*, vol. 22, pp. 145-155, 2007.



- [6] Paudyal, S.; Canizares, C.A.; Bhattacharya, K., "Optimal Operation of Industrial Energy Hubs in Smart Grids," *IEEE Transactions on Smart Grid*, vol. 6, no. 2, 2015.
- [7] Holjevac, Ninoslav; Capuder, Tomislav; Kuzle, Igor. Adaptive Control for Evaluation of Flexibility Benefits in Microgrid Systems, *Energy*, vol. 92, Part 3, pp. 487-504, 2015.
- [8] Holjevac, N, Capuder, T, Zhang, N, Kuzle, I, Kang, C, "Corrective receding horizon scheduling of flexible distributed multi-energy microgrids", *Applied Energy*, vol. 207, pp. 176-194, 2017.
- [9] Yi Wang, Ning Zhang, Chongqing Kang, Daniel S. Kirschen, Jingwei Yang, Qing Xia, "Standardized Matrix Modeling of Multiple Energy Systems", *IEEE Transactions on Smart Grid*, early access, 2018
- [10] Mao, M, Jin, P, Hatziargyriou, N.D.; Chang, L, "Multiagent-Based Hybrid Energy Management System for Microgrids," *IEEE Transactions on Sustainable Energy*, vol. 5, no. 3, pp. 938-946, 2014.
- [11] Maziar Yazdani-Damavandi, Nilufar Neyestani, Miadreza Shafie-khah, Javier Contreras and Jo~ao P. S. Catal~ao, "Strategic Behavior of Multi-Energy Players in Electricity Markets as Aggregators of Demand Side Resources using a Bi-level Approach", *IEEE Transactions on Power Systems*, Volume: 33, Issue 1, pp. 397-411, 2018.
- [12] N Holjevac, T Capuder, I Kuzle, N Zhang, C Kang, "Modelling Aspects of Flexible Multi-Energy Microgrids", 2018 Power Systems Computation Conference (PSCC), pp.1-7, Dublin, Ireland, 2018.
- [13] Luburić, Zora; Pandžić, Hrvoje; Plavšić, Tomislav; Teklić, Ljupko; Valentić, Vladimir, "Role of energy storage in ensuring transmission system adequacy and security", *Energy*, Vol. 156, pp. 229-239, 2018.
- [14] N. Holjevac, T. Capuder, I. Kuzle, "Defining key parameters of economic and environmentally efficient residential microgrid operation", *Energy Procedia*, vol. 105, pp. 999-1008, 2017.
- [15] Pandžić, H., Kuzle, I., „Energy Storage Operation in the Day-Ahead Electricity Market“. *IEEE 2015 12th International Conference on the European Energy Market (EEM)*, Lisbon, 2015.
- [16] Conejo, A.J., Castillo, E., Mínguez, R., Garcia-Bertrand, R., Netherlands, Springer-Verlag Berlin Heidelberg, 2006.

**Publication 6 - Model Predictive Control for Scheduling of Flexible Microgrid Systems**

Kuzle, Igor, Holjevac, Ninoslav; Capuder, Tomislav, "Model Predictive Control for Scheduling of Flexible Microgrid Systems", *Digital Proceedings of the 9th Conference on Sustainable Development of Energy, Water and Environment Systems (SDEWES 2014)*, Venice, Italy, pp. 1-20, 2014.

- 20 pages

# Model Predictive Control for Scheduling of Flexible Microgrid Systems

Igor Kuzle

University of Zagreb Faculty of Electrical Engineering and Computing  
e-mail: igor.kuzle@fer.hr

Ninoslav Holjevac\*

University of Zagreb Faculty of Electrical Engineering and Computing  
e-mail: ninoslav.holjevac@fer.hr

Tomislav Capuder

University of Zagreb Faculty of Electrical Engineering and Computing  
e-mail: tomlav.capuder@fer.hr

## ABSTRACT

Microgrids, groups of loads and generators in the same location with centralized control, have the ability to balance the variability and the forecast error of the renewable sources (RES) within them, thus reducing the need for the conventional reserve. The main goal of this paper is to explore the influence of the microgrid components on its ability to operate independently from the distribution grid. A deterministic model using mixed integer linear programming (MILP) is developed to simulate the microgrid operation over one year period and used to determine the optimal microgrid parameters with respect to the amount of unused energy.

In the second part of this paper a developed model is expanded with model predictive control (MPC) approach to capture the behaviour of the microgrid connected to the rest of the distribution grid, modelling the uncertainties of forecasting RES production by stochastic programming. The model is capable of evaluating the impact of variable energy prices and the impact of energy balancing tariffs depending on the amount of balancing energy needed on the operation of flexible units such as electric heat pumps (EHP), micro Combined Heat and Power plants ( $\mu$ CHP) and heat storage (HS).

## KEYWORDS

Flexible units, Microgrids, Mixed Integer Linear Programming (MILP), Model Predictive Control (MPC), Renewable Energy Sources (RES), Uncertainty

---

\* Corresponding author: [ninoslav.holjevac@fer.hr](mailto:ninoslav.holjevac@fer.hr)

## 1. INTRODUCTION

Integration of renewable energy sources (RES) today is largely driven by governmental incentives, especially for RES on a small domestic scale. As the share of RES increases, the concept of incentives becomes unsustainable and the need to develop new approaches becomes inevitable. Traditionally, there has been a separation between the production and consumption of electricity where consumption has been regarded a passive part with very little capabilities for control. Therefore any generation mismatch caused by variations in RES generation had to be compensated by other generating units. Today the development is shifting towards enabling the flexibility from the consumer, ranging from flexible demand to distributed generation. The range of controllable and RES technologies at the low voltage level covers a wide range of units: photo-voltaic units (PV), wind power plants (WPP), electric heat pumps (EHP), micro combined heat and power units ( $\mu$ CHP), thermal energy storage (HS), battery storage (BS) etc. Aggregating these technologies creates a market entity capable of not only isolated operation but also interaction with the electric system.

Any such system could be integrated with the rest of power grid's control system by means of aggregation and market mechanism. Although ideas of virtual power plants and standalone microgrids are not new [1], there is still a lack of models capable of representing the behaviour and scheduling of such clusters of units. A good model must provide robust response of microgrid to fluctuations of connected RES and, if needed, has to ensure stand-alone operation with minimum to no interaction with the rest of the electrical grid.

The methodology for decision-making on local microgrid level is not simple to find and has many key factors that have to be included. Microgrid comprises of both dispatchable units (e.g. distributed generators) needed to balance the microgrid and uncontrollable units such as RES whose production cannot be precisely estimated. Additionally, flexible loads (FL), energy storage systems (EES) and connection to the rest of the system have to be modelled in order to find optimal control approach. There are several methods found in literature that tackle the problem of finding the best control algorithm. In [2] Sanseverino *et al.* look for a solution of optimal operation of a microgrid using a non-dominated sorting algorithm that includes forecast error. Different approach using MILP (Mixed Integer Linear Programming) for a mid-term virtual power plant dispatch optimization was investigated in [3] by Pandžić *et al.* where uncertainty of the wind and solar power generation is settled using storage in order to provide flexible operation. Day ahead planning horizon is more commonly used when operation of microgrid is considered [4]. Furthermore, complex and computationally demanding approaches such as multiagent modelling presented by Want *et al.* in [5] or evolutionary strategies presented by Basu in [6] do not guarantee global optimality of the solution.

MILP approach coupled with Model Predictive Control (MPC) has recently proved to be an efficient approach since it is based on future predictions as well as present state of the system. This combination provides a good mechanism to deal with uncertainty of predictions. Optimization centred around battery storage is presented in [7] by Malysz *et al.* where battery is used to maximize economic benefits for both the customers and utility operators. Perkovic *et al.* [8] used receding horizon model predictive control for smart management of residential type microgrid while taking into account Plug-in Electric Vehicles (PEV) as energy storage with the goal of maximizing profit. Energy management system using rolling horizon strategy for an isolated renewable-based microgrid is presented by Marietta *et al.* in [9]. Another MPC control algorithm which minimizes the operation cost, tested on a real microgrid, and proves the feasibility of proposed approach was described by Parisio *et al.* in [10].

With respect to different or multi objective functions, the available literature proposes several approaches and possibilities. As stated before, genetic algorithms can incorporate multi-objective optimization and consider both, for example, economic benefits and emission reductions, as in example by Deng *et al.*[11], but the final result is not guaranteed to be the global optimum as it is the case with MILP. Many optimization algorithms set minimization of operational costs or maximization of profit as objective functions which, in most cases, are dual functions. Recently, approach that minimizes emissions and emissions cost has been presented in [12], proposed by Ren *et al.*, trying to reduce environmental impacts of energy production. It is important to notice that there are currently no integrated models including all the important elements (PEV, FL, battery and heat storage,  $\mu$ CHP etc.) and providing a comprehensive study of operational costs, energy usage, energy curtailment, losses, equipment degradation information etc. The focus of this paper is on defining the flexibility that can be gained by optimally coupling heat storage,  $\mu$ CHP, EHP and flexible demand in microgrid operation.

## 2. MAIN CONTRIBUTIONS

In this paper control-oriented approach for microgrid operation is developed. Two models are developed, deterministic and rolling unit commitment incorporating MPC. These models are used to simulate daily operation of a microgrid for a period of one year. The microgrid consists of 300 households (each modelled by a specific heat and electricity demand profile), multiple DG units ( $\mu$ CHP, EHP, boiler and heat storage), and household installed RES units, in particular solar and wind.

In all the simulations certain assumptions were made:

- microgrid optimization and operation is primarily market driven and voltage and frequency stability are assumed to be controlled on the lower level and are not considered;
- microgrid consists of the following elements: PV arrays, wind turbines,  $\mu$ CHP units, EHP units, flexible and inflexible loads, heat storage, and boiler units. The concept relays only on units widely adopted by the consumers and thus does not include BS or PEV. It should be noted that the model can easily be expanded to include additional technologies;
- central controller is assumed to have all the required information about the present state of the microgrid (boiler, EHP and  $\mu$ CHP operational points, house heat storage unit capacity, market energy prices, RES production);
- energy exchanged with the grid is assumed to be bought/sold at day-ahead market;
- microgrid is small enough to act as a price taker and does not influence the formation of prices on the market;
- connection with the distribution grid is unconstrained;
- flexible consumers are not compensated for rescheduling their output;
- sampling time is constant ( $\Delta T\tau = t_k - t_{k-1}$ ) and the ration between power and energy is therefore also constant.

The first contribution of the paper is defining the value of different flexible components, such as EHP,  $\mu$ CHP and Flexible Load (FL), on microgrids ability to operate in the off grid mode. A mathematical model based on Mixed Integer Linear Programming (MILP) is developed to simulate the off grid operation over one year period, determining the optimal parameters with respect to the amount of unused energy on microgrid level. This series of simulations was done with deterministic input data. A comparison of deterministic model simulation off-grid and on-grid is also given. Determined optimal sizes of installed wind aggregates and PV units for

given microgrid configuration are afterwards used to study how much flexibility can be gained by altering heat storage capacity, flexible demand percentage and percentage of specific controllable DG unit installed with consumers. The flexibility is evaluated as the yearly amount of unused energy; curtailed RES electricity and wasted heat.

The second contribution of the paper is the rolling unit commitment model incorporating MPC algorithm optimizing the microgrid operation on a daily basis considering the uncertainties inherent to the RES production and demand forecasting. Adding MPC improves the system's ability to react to prediction errors since the controller takes into account a series of future moments instead of making decision just based on current status of the system. The developed model minimizes day ahead scheduling error of the microgrid as well as the operational cost based on penalizing export/import balancing energy cost and total fuel cost.

It should be noticed that, through a number of analyses, the paper clearly recognizes benefits of coupling and coordinated operation of  $\mu$ CHP and EHP units, supported with HS as heat buffer, in order to compensate for the fluctuating nature of RES production and to minimize, or if possible totally exclude, balancing interaction with distribution network. This way microgrid can operate as independent entity at any time needed, follow the scheduled import/export plan and compensate for unpredictable fluctuations in RES production.

### 3. MICROGRID SYSTEM COMPONENTS AND MODELING

Basic concept of the modelled microgrid is shown on Figure 1. As it can be seen the microgrid consists of heat and electricity consumers (households), electricity producers ( $\mu$ CHP), heat producers (EHP,  $\mu$ CHP and auxiliary boilers) and buffers decoupling heat and electricity demand - heat storages (HS). The possibility of direct electrical energy storage is not modelled, even though the heat storage in combination with  $\mu$ CHP and EHP units can provide a certain ability to change the electrical power output [13], [14]. All microgrid components are modelled using CPLEX solver FICO Xpress [15]. Data manipulation and results extraction was done using MatLab 2013.

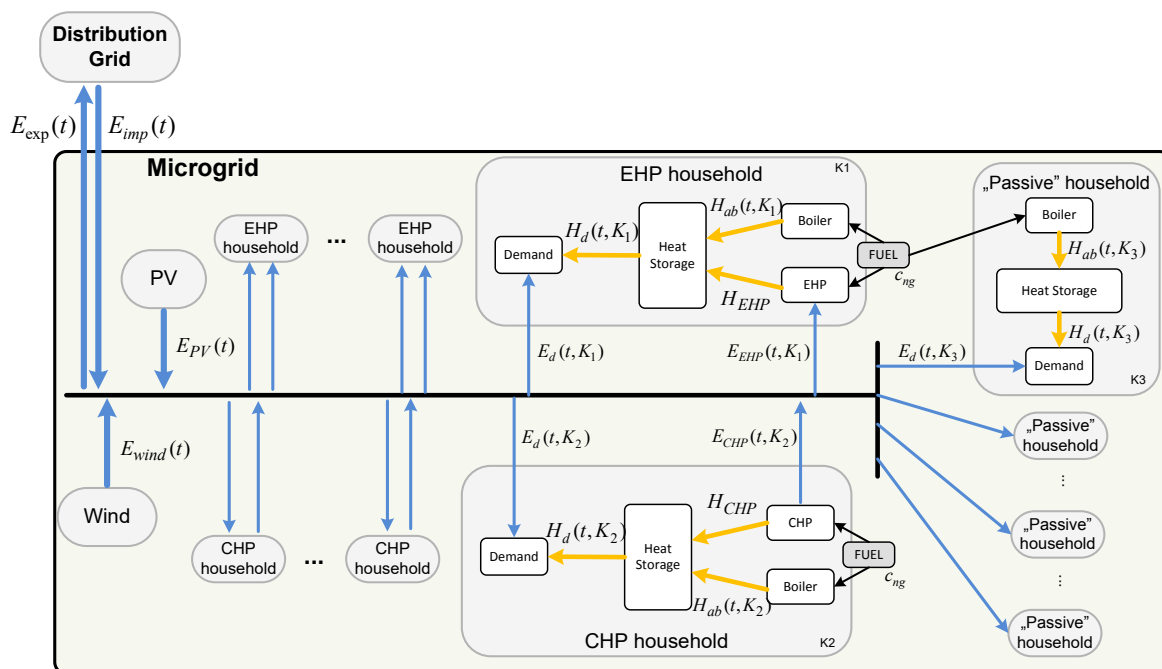

Figure 1. Schematic of a microgrid

In tables 1, 2 and 3 a list of indices, input and decision variables is given for easier understanding of the mathematical formulation parameters used in optimization problem formulation.

Table 1. Parameters of the optimization model

<b>Parameter</b>	<b>Description</b>
$K$	Total number of households
$i$	Counter referring to $i$ -th household
$t$	Current simulation step
$T_{\max}$	Time horizon of the simulation [hour]
$\tau$	Simulation time step duration [hour]
$c_{ng}(t)$	Natural gas supply price [€/kWh]
$P$	Penalty factor for waste heat and wind energy
$H_{chp\_max}(t,i)$	Maximum heat production of $\mu$ CHP unit [kWh]
$\eta_{chp\_e}(t,i)$	Electric efficiency of $\mu$ CHP unit
$\eta_{chp\_t}(t,i)$	Thermal efficiency of $\mu$ CHP unit
$H_{ehp\_max}(t,i)$	Maximum heat production of EHP unit [kWh]
$COP(t,i)$	Coefficient of performance of EHP unit
$H_{ab\_max}(t,i)$	Maximum thermal output of a boiler unit[kWh]
$\eta_{ab}(t,i)$	Boiler efficiency
$H_{hs\_max}(t,i)$	Maximum heat storage capacity [kWh]
$\eta_{hs}(t,i)$	Heat storage efficiency
$P_{flex}$	Percentage of total electrical load defined as flexible
$C_{flex\_max}(t)$	Maximum capacity of flexible load being rescheduled [kWh]

Table 2. Forecasts (inputs of the optimization algorithm)

<b>Parameter</b>	<b>Description</b>
$H_d(t,i)$	Heat demand of $i$ -th household [kWh <sub>t</sub> ]
$E_d(t,i)$	Electricity demand of $i$ -th household [kWh <sub>e</sub> ]
$E_{wind}(t)$	Standardized per 1 kWh installed power hourly wind production [kWh]
$E_{PV}(t)$	Standardized per 1 kWh installed power hourly PV production [kWh]
$c_{imp}(t)$	Import electricity price [€/kWh]
$c_{exp}(t)$	Export electricity price [€/kWh]

Table 3. Decision variables of the optimization model

Parameter	Description
$H_{chp}(t,i)$	Heat production of $\mu$ CHP unit [kWh]
$H_{hs}(t,i)$	Heat flow through heat storage [kWh]
$C_{hs}(t,i)$	Heat storage capacity at simulation step t [kWh]
$H_{ab}(t,i)$	Heat production of a boiler unit [kWh]
$E_{flex}(t)$	Flexible loads being rescheduled [kWh]
$E_{wind\_gen}(t)$	Used wind energy [kWh]
$E_{wind\_curt}(t)$	Curtailed wind energy [kWh]
$X_{wind}$	Installed wind power [kW]
$X_{PV}$	Installed PV power [kW]
$E_{imp}(t)$	Imported energy from the grid [kWh]
$E_{exp}(t)$	Exported energy to the grid [kWh]
$F(t)$	Total fuel energy used [kWh]

### 3.1 Micro Combined Heat and Power unit ( $\mu$ CHP)

A number of households with larger heat consumption use  $\mu$ CHP units as main heat source.  $\mu$ CHP units are modelled with peak power of  $8 \text{ kW}_t$  and technical minimum of  $1,6 \text{ kW}_t$ . The coefficient  $\tau$  is used since technical min/max constraints are expressed in kWh values. This way the model is able to capture different time step resolutions which usually depend on the market structure and settlement periods in the observed market. In all simulations in this paper a 0,5 hour time step is considered.

$$H_{chp\_min}(i) \cdot \tau \leq H_{chp}(t,i) \leq H_{chp\_max}(i) \cdot \tau \quad (1)$$

It is assumed that  $\mu$ CHP units can adjust their output fast enough and no ramp constraints have been introduced. Production of electrical energy of  $i$ -th  $\mu$ CHP unit in every time step:

$$E_{chp}(t,i) = H_{chp}(t,i) \cdot \frac{\eta_{chp\_e}(t,i)}{\eta_{chp\_t}(t,i)} \quad (2)$$

Fuel consumption of all CHP units is:

$$fuel_{chp\_total}(t) \leq \sum_i^K \frac{H_{chp}(t,i)}{\eta_{chp\_t}(t,i)} \quad (3)$$

### 3.2 Electric Heat Pump unit (EHP)

A number of households have EHP as main heat source. EHP is modelled with its peak heat power of  $10 \text{ kW}_t$  and coefficient of performance COP which varies throughout the year. Assumed EHP type is air-water and is therefore dependent on the outdoor temperature and temperature difference. Households that have no EHP have the  $H_{chp}(t,i)$  equal to 0.



$$H_{ehp}(t,i) \leq H_{ehp\_max}(t,i) \cdot \tau \quad (4)$$

Heat production of EHP unit in every time step and household is:

$$E_{ehp}(t,i) = \frac{H_{ehp}(t,i)}{COP(t,i)} \quad (5)$$

### 3.3 Auxiliary boiler (AB) and heat storage (HS)

All households are equipped with gas boiler which is being used when heat demand is too large to be covered by primary heat sources (EHP or  $\mu$ CHP) or when optimization algorithm dispatches it under right circumstances. Boiler has peak power of 10 kW<sub>t</sub> and efficiency of fuel conversion is 85%:

$$H_{ab}(t,i) \leq H_{ab\_max}(t,i) \cdot \tau \quad (6)$$

$$fuel_{ab\_total}(t) \leq \sum_i^K \frac{H_{ab}(t,i)}{\eta_{ab}(t,i)} \quad (7)$$

Additionally all households have a simple water tank, or heat storage with the capacity  $C_{hs\_max}$  of 6 kWh. To store that amount of heat, assuming water temperature difference of 30 to 35 °C, approximately 150 liters of water are needed. Heat losses on hourly bases are assumed to be 4%, which corresponds to losses of 2% every half an hour. Heat storage has constraints due to its charge/discharge time:

$$H_{hs}(t,i) \leq C_{max\_hs}(t,i) \cdot \tau \quad (8)$$

Storage capacity limit and behaviour are described with following inequalities:

$$C_{hs}(t,i) \leq C_{hs\_max}(t,i) \quad (9)$$

$$C_{hs}(t,i) = \eta_{hs}(t,i) \cdot C_{hs}(t-1,i) - H_{hs}(t,i) \quad (10)$$

### 3.4 Heat demand

Daily heat demand is modelled with 5 different curves which are evenly assigned among all households (Figure 2). The heat consumption profiles are extracted from data available for United Kingdom [16]. Heat demand throughout the year is modelled with seasonal variations each with its 5 different heat demand profiles.

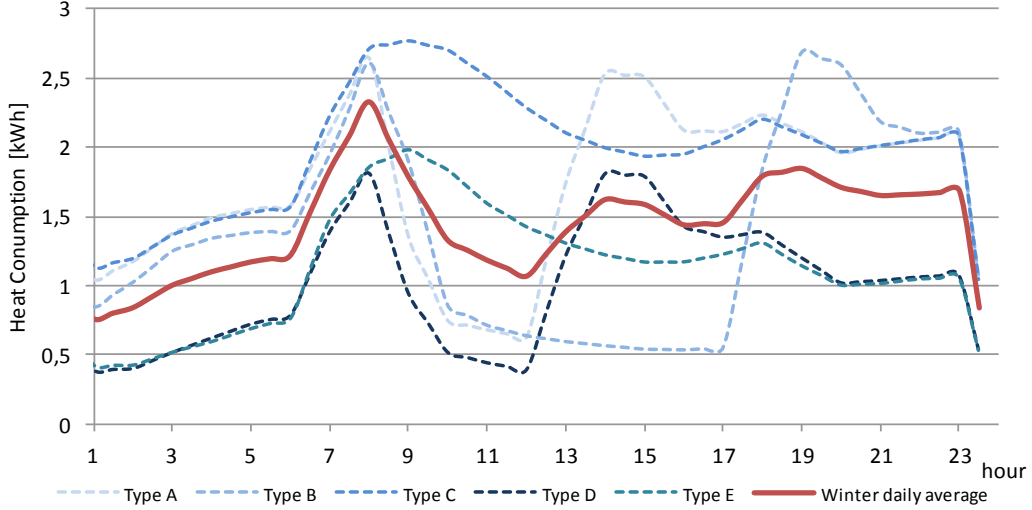

Figure 2. Daily heat consumption for different household types for a winter day

Heat demand of each household is modelled with following inequality:

$$H_d(t,i) \leq H_{chp}(t,i) + H_{ehp}(t,i) + H_{ab}(t,i) + H_{hs}(t,i) \quad (11)$$

To ensure the safe microgrid operation under all circumstances waste of heat is allowed:

$$H_{waste}(t) \leq \sum_{i=1}^K H_{chp}(t,i) + H_{ehp}(t,i) + H_{ab}(t,i) + H_{hs}(t,i) \quad (12)$$

### 3.5 Flexible electrical load

A simple model to represent demand side management is incorporated by defining a percentage of total electrical demand that can provide flexible response. Initially the percentage  $p_{flex}$  is set to be 15% of  $E_d(t)$  at any give period:

$$-p_{flex} \cdot E_d(t) \leq E_{flex\_total}(t) \leq p_{flex} \cdot E_d(t) \quad (13)$$

$E_{flex}(t)$  is positive for load reduction and negative for load increase.

The information about the total amount of shiftable loads that are being rescheduled at every time step is modelled using flexible load maximum capacity:

$$-C_{flex\_max}(t,i) \leq C_{flex}(t,i) \leq C_{flex\_max}(t,i) \quad (14)$$

$$C_{flex}(t,i) \leq C_{flex}(t-1,i) - E_{flex}(t,i) \quad (15)$$

### 3.6 Renewable energy sources

Input data for RES modelling are measured hourly values over a one year period [17] depicted on Figure 3. The input data is standardized for 1 kW of installed wind or solar power.

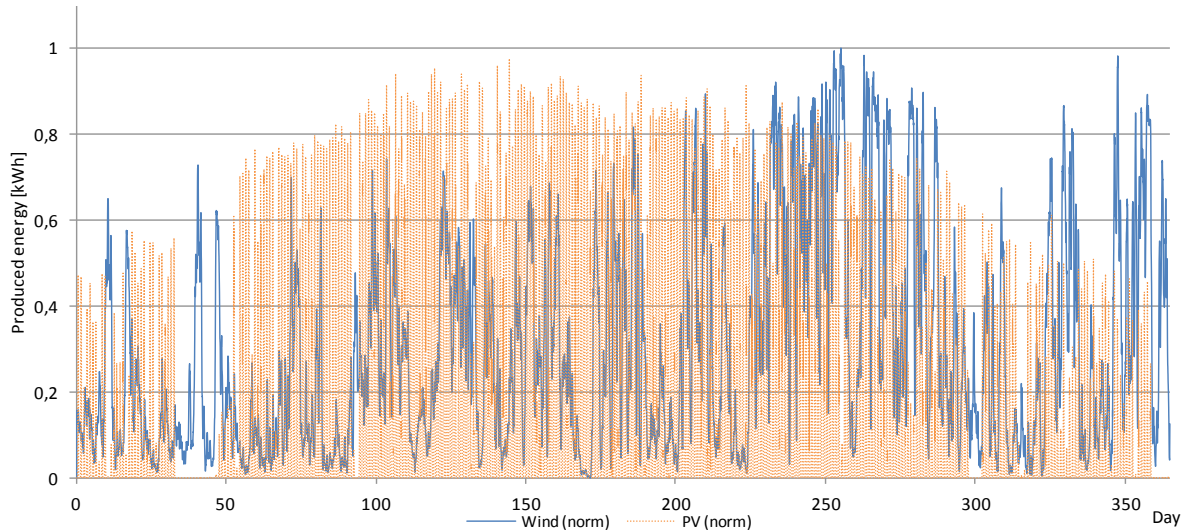

Figure 3. Standardized wind and solar production

One of the goals of deterministic model is to determine optimal installed values of wind turbines and PV and therefore their production is defined as deterministic input data ( $E_{wind}(t), E_{PV}(t)$ ) multiplied with their installed capacity:

$$E_{wind\_real}(t) = E_{wind}(t) \cdot X_{wind} \quad (16a)$$

$$E_{PV\_real}(t) = E_{PV}(t) \cdot X_{PV} \quad (16b)$$

The correlation between consumption and PV production is much better than one with wind production. Therefore only wind curtailment is introduced:

$$E_{wind\_curt}(t) + E_{wind\_gen}(t) = E_{wind\_real}(t) \quad (17)$$

### 3.7 Electrical demand

Similarly to heat demand electrical demand is on a daily basis represented with 3 different load consumption profiles (winter, spring/autumn, summer) depicted on Figure 4.

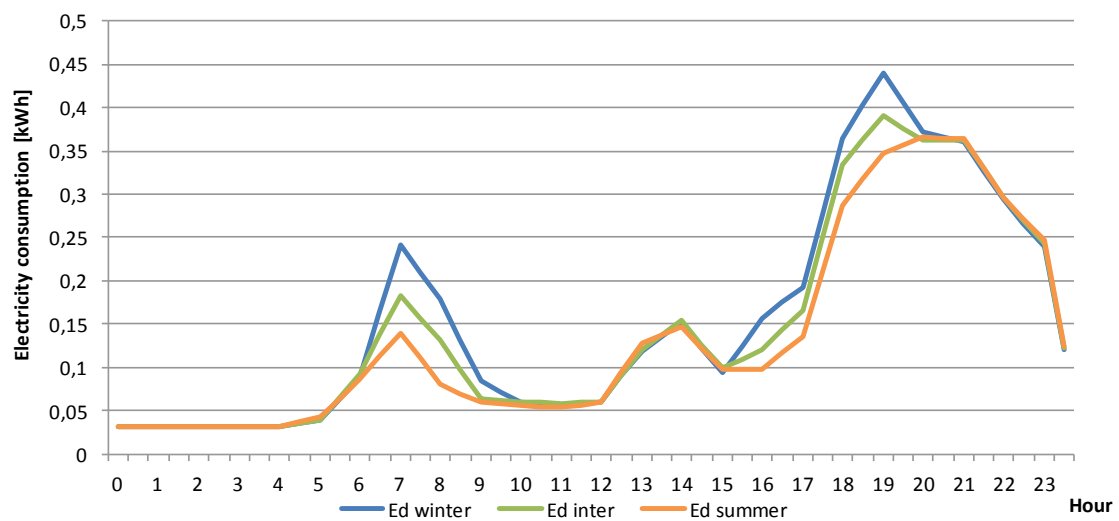

Figure 4. Electrical demand profile for 3 different seasons

Equilibrium between electricity production and consumption must be achieved at every time step:

$$E_d(t,i) + E_{\text{exp}}(t) + \sum_{i=1}^K E_{\text{ehp}}(t,i) = E_{\text{imp}}(t) + E_{\text{pv\_real}}(t) + E_{\text{wind\_gen}}(t) + \sum_{i=1}^K E_{\text{chp}}(t,i) + \sum_{i=1}^K E_{\text{flex}}(t,i) \quad (18)$$

### 3.8 Cost function

Total fuel used is equal to fuel used by boiler and CHP units:

$$F(t) = \text{fuel}_{\text{chp\_total}}(t) + \text{fuel}_{\text{ab\_total}}(t) \quad (19)$$

Day ahead market prices are taken from the European electricity market (EEX) [18]. Minimization of total microgrid operation cost is the objective function of the optimization model:

$$\text{COST} = \sum_{t=1}^{T_{\text{max}}} \left( F(t) \cdot c_{\text{ng}}(t) + E_{\text{imp}}(t) \cdot c_{\text{imp}}(t) - E_{\text{exp}}(t) \cdot c_{\text{exp}}(t) + P \cdot E_{\text{wind\_curt}}(t) + P \cdot H_{\text{waste}}(t) \right) \quad (20)$$

Penalty factor  $P$  is used to highlight the importance of avoiding energy waste and losing potential wind production. Factor 300 was used in off-grid simulation of a deterministic model when optimal RES installed values were determined.

## 4. DETERMINISTIC MODEL RESULTS

The deterministic model described in the preceding section is run for  $i_{\text{max}} = 17520$  steps representing half an hour periods during one year time. All parameters are shown in the following table (Table 4).

Table 4. Simulation parameters initial values

Parameter	Unit	Value
Simulation time $T_{\text{max}}$	[hour]	8760
Simulation time step duration $\tau$	[hour]	0,5
Number of households $K$	--	300
Penalty factor for unused energy $P$	--	300
Natural gas price $c_{\text{ng}}$	[€/kWh]	0,025
Household heat storage capacity $C_{\text{hs\_max}}$	[kWh <sub>t</sub> ]	6
Flexible load share $p_{\text{flex}}$	[%]	15
Maximum flex load capacity $C_{\text{flex\_max}}$	[kWh]	50
Electric efficiency of $\mu$ CHP unit $\eta_{\text{chp\_e}}$	--	0,38
Thermal efficiency of $\mu$ CHP unit $\eta_{\text{chp\_t}}$	--	0,55
Maximum thermal output of CHP unit $H_{\text{chp\_max}}$	[kWh <sub>t</sub> ]	8
Maximum thermal output of EHP unit $H_{\text{ehp\_max}}$	[kWh <sub>t</sub> ]	10
Share of households with CHP based heating	[%]	45
Share of households with EHP based heating	[%]	45
Share of households with only boiler based heating	[%]	10

Parameter	Unit	Value
Coefficient of performance of EHP unit $COP(t)$	--	3,5 summer 3 inter 2,5 winter
Maximum thermal output of a boiler unit $H_{ab\_max}$	[kWh <sub>t</sub> ]	10
Boiler efficiency $\eta_{ab}$	--	0,85
Maximum heat storage capacity $C_{hs\_max}$	[kWh <sub>t</sub> ]	6
Heat storage efficiency $\eta_{hs}$	--	0,98
Heat storage discharge/charge rate per time step $E_{hs\_max}$	[kWh <sub>t</sub> ]	$C_{hs\_max} \cdot \tau$

Off-grid operation is simulated where  $E_{imp}(t)$ ,  $E_{exp}(t)$  are equal 0.

Optimal values of installed wind and solar power were calculated:

- $X_{wind\_opt} = 65 kW$  and  $X_{PV\_opt} = 113 kW$ .

These calculated values are later used as input parameters (reference) in MPC model.

As described before high penalty factor  $P$ , in the objective function for waste energy, achieves that only 0,31% (12.989 kWh) of total energy spent has to be spilt (Figure 5). Heat waste occurs in off-grid mode when there is not enough electrical energy (EE) production to cover the demand (little to no wind or sun); in those cases  $\mu$ CHP units have to produce more and consequently increase heat production which is not needed and cannot be stored in HS. Additionally, similar case happens when there is a surplus of electrical energy (high wind and sun generation) so optimization algorithm increases EHP heat production to balance the microgrid. Wind is curtailed in periods when there is a surplus of EE and there is no option of it being indirectly stored (indirectly in HS).

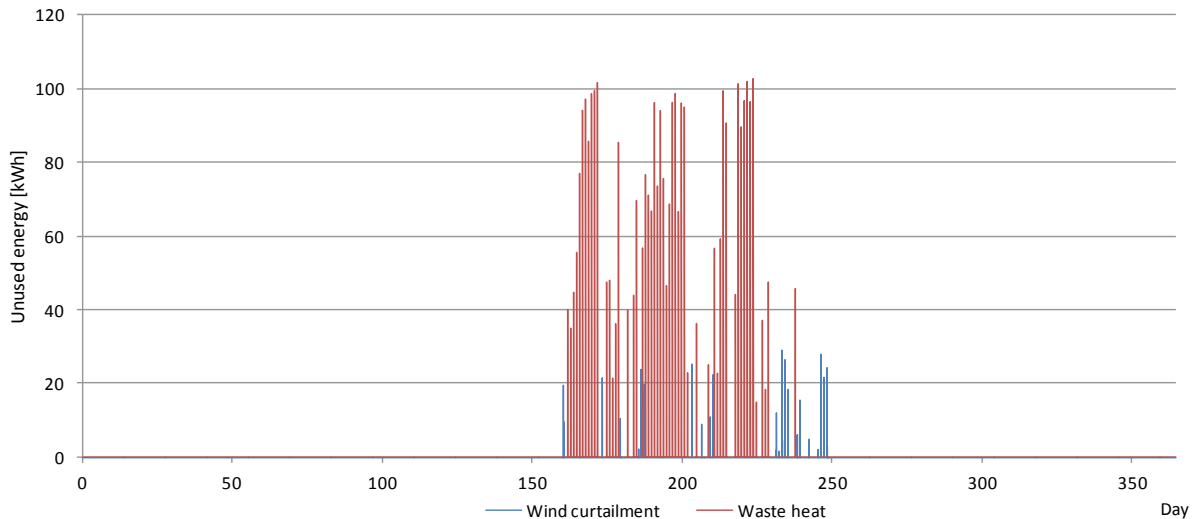

Figure 5. Curtailed wind energy and surplus of produced heat energy

Sensitivity analysis of the change in installed wind and solar capacity was performed in order to show how non optimal values increase the total amount of curtailed wind and surplus of heat energy (Figure 6). While one parameter was being changed the other was set at the optimal value.

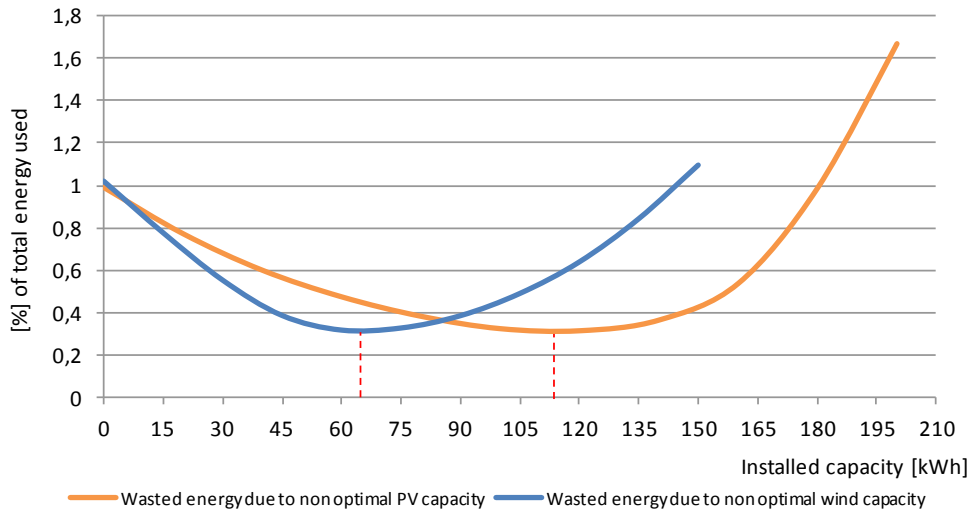

Figure 6. Connection between installed RES capacity and unused energy

The possibility of storing heat energy is one of the elements that provide flexibility in grid operation. With large enough storage units  $\mu$ CHP units do not have to follow the demand exactly. Furthermore, larger storage capacity can compensate for the non optimally dimensioned microgrid elements like installed power of RES. The results of the sensitivity analysis depicted on Figure 7. shows dependency of storage size and total unused energy from RES. Installing a storage unit of 12 kWh<sub>t</sub> (6 kWh<sub>t</sub> is initial storage size) in every household can reduce total unused energy below 0,31% margin for 50% more RES that calculated as the optimal values.

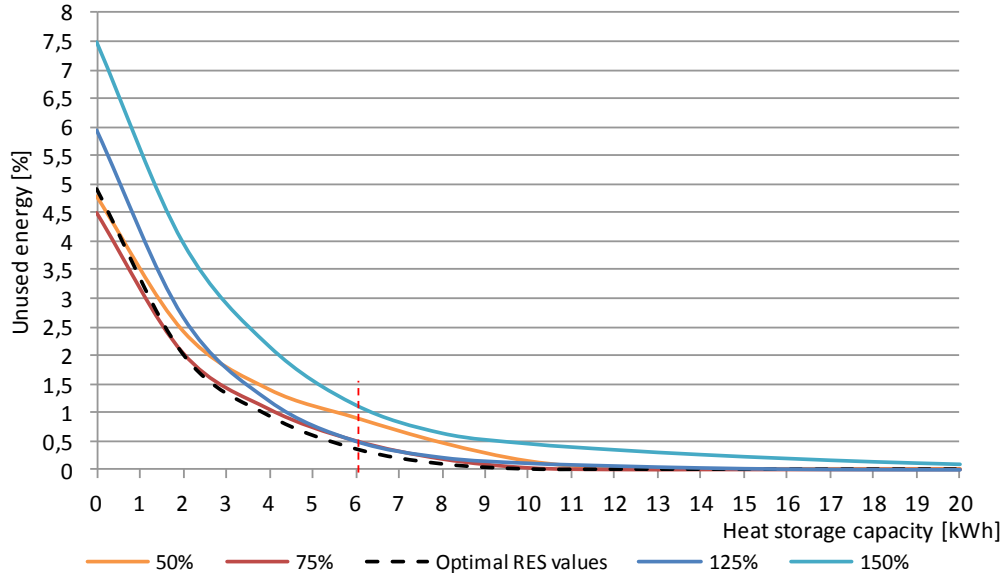

Figure 7. Connection between HS capacity and unused energy

Similar analysis was conducted for flexible load share. Reference is the simulation with optimal values (Figure 8).

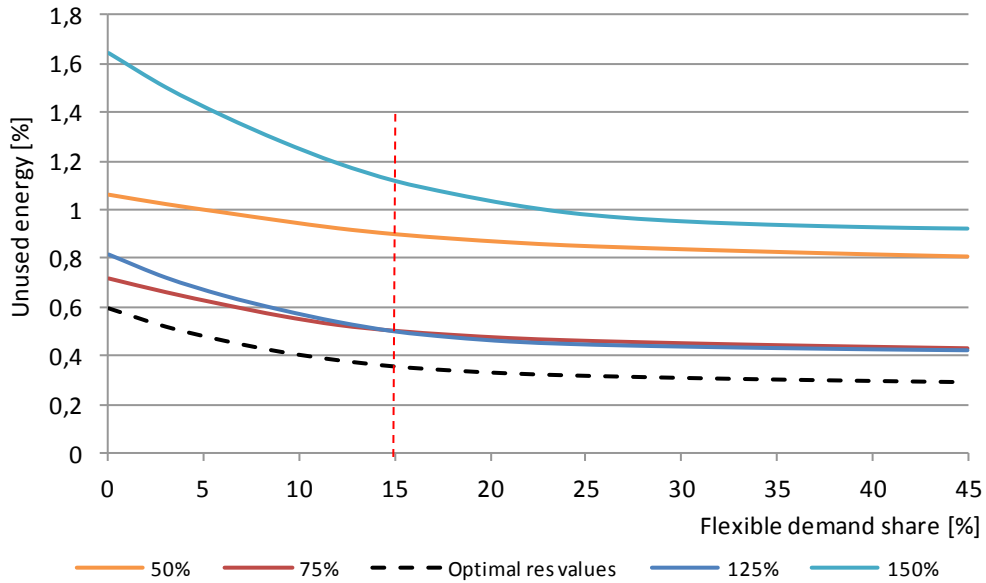

Figure 8. Connection between flexible demand share and unused energy

Flexible demand has smaller influence on the unused energy compared to heat storage capacity. The differences in unused energy for different FL shares are not stressed and curves get to the saturation point quickly.

Interesting information is provided by the analysis conducted to determine what impact different ratios of heating types ( $\mu$ CHP/EHP) has on the amount of unused energy.  $\mu$ CHP and EHP units complement each other in operation as seen in the wasted energy analysis, and together can provide a certain amount of flexibility. Results (Figure 9.) show that the least value of unused energy is achieved if 60% of households have  $\mu$ CHP and 40% EHP based heating. Boiler based household heating type share is set to 0 during this sensitivity analysis meaning each household has either EHP or  $\mu$ CHP installed.

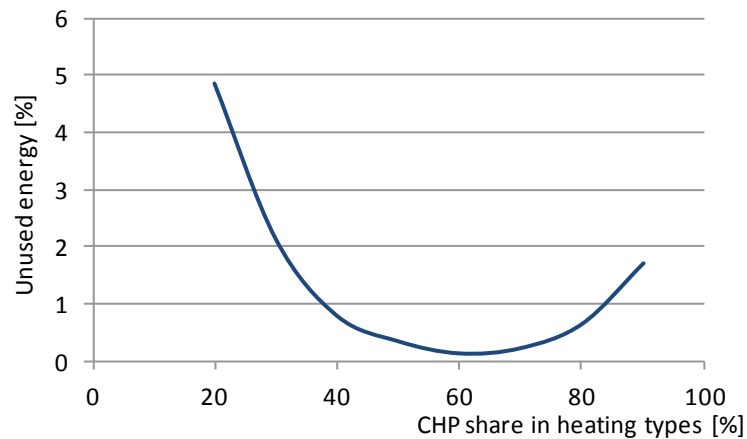

Figure 9. Impact of CHP share in heating types on unused energy

For a  $\mu$ CHP share of 10% in the off-grid mode the units have to be pushed to operate at their maximum point in order to produce enough EE and this results in a lot of wasted heat. As the share moves beyond 60% there is not enough EHP electrical demand to balance periods of high RES generation and energy is wasted again.

#### 4.1 On-grid simulation

The results have shown that the modelled microgrid can operate independently with very little unused energy. In case there is a connection with the rest of the distribution system the microgrid can exchange electrical energy with the system and its operation is driven by market signals. Results of an on-grid operation are shown in Table 5.

Table 5. On-grid and off-grid operation comparison

<b>Microgrid operation indicator</b>	<b>Off-grid <math>P = 300</math></b>	<b>Off-grid <math>P = 1</math></b>	<b>On-grid <math>\forall P^{**}</math></b>
Total energy produced [kWh]	4.190.934	4.192.833	4.177.944
Total EE used [kWh <sub>e</sub> ]	764.926	764.926	764.926
Total heat used [kWh <sub>t</sub> ]	3.559.675	3.559.675	3.413.018
Wind curtailment [kWh]	1.301	1.333	0,00
Wasted heat [kWh]	11.689	13.557	0,00
Imported EE [kWh]	0,00	0,00	266.934
Exported EE [kWh]	0,00	0,00	547.112
<b>Unused energy [%]*</b>	<b>0,31</b>	<b>0,36</b>	<b>0,00</b>
<b>Boiler production [kWh]</b>	<b>453.621</b>	<b>453.697</b>	<b>87.756</b>
<b>Boiler fuel cost [€]</b>	<b>13.341</b>	<b>13.344</b>	<b>2.581</b>
<b>TOTAL COST [€]</b>	<b>99.320</b>	<b>99.625</b>	<b>68.477</b>

\* Percentage of total energy used

\*\*Value of penalty factor  $P$  has no effect on on-grid operation mode.

In case when the microgrid operates connected to the rest of the system there is no unused energy. Additionally the boilers are forced to produce much less heat compared to off-grid mode where they are used to balance the heat production and demand. Consequently amount of fuel and the operational cost in boilers is reduced drastically.

The operational cost results presented in Table 5 do not take emissions into account. Additionally, investment costs could be introduced to get more precise information about the profitability of installing different microgrid units (battery storage, heat storage, RES, greater flexible load share, plug-in electric vehicles integration etc.). These expansions are a part of future work.

#### 5. THE ROLLING UNIT COMMITMENT MODEL INCORPORATING MPC

If a microgrid operates connected to the rest of the system, it participates in the energy market and its operation will be driven by market signals. In order to simulate dynamic behaviour of a microgrid the paper observes the microgrid as a single market entity/player. As such it has to ensure self balancing and comply with the contracted exchange schedule at the day ahead market. To be able to do that it has to consider forecasting errors and be able to reschedule, changing the operating points of flexible units as new information on uncertainty parameters becomes available. For this reason the extension of previously described deterministic model is made. The main goal was to investigate in what amount forecast uncertainties impact the microgrid operation and is the microgrid flexible enough to compensate the stochastic nature of RES installed. It is expected and desired that microgrid has at least neutral impact on grid (respecting proposed export/import schedules). All production and consumption variations should be balanced internally with controllable microgrid elements that can provide flexibility.



## 5.1 Model Predictive Control (MPC) framework

The results of a deterministic model have shown that the modelled microgrid can operate independently with very little unused energy in deterministic environment. In case there is a connection with the rest of the distribution system the microgrid can exchange electrical energy and energy waste is avoided. This interaction is even more important in stochastic environment where the need for balancing energy grows due to forecast errors.

The MILP unit commitment control algorithm employs MPC to minimize the impact of forecast errors. MPC is a control method which is used for discrete control; during one simulation step control signals do not change. The MPC concept and developed unit commitment algorithms flowchart are depicted on Figure 10.

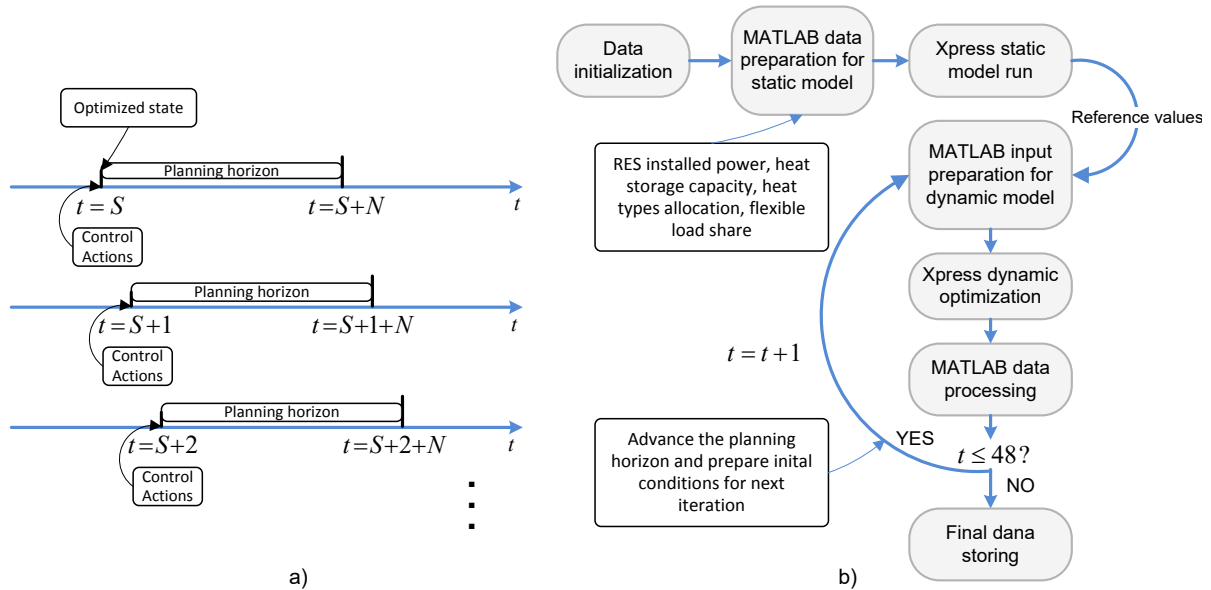

Figure 10. a) MPC rolling horizon concept b) Flowchart of the MPC optimization model

At every time step  $t$  the algorithm estimates the next  $N$  system states and reaches an optimal desired state. Control actions are applied and the state stays unchanged until the start of a new iteration. At the start of next time step  $t + 1$  again  $N$  system states are estimated based on new forecasts that include realized input data for preceding iteration. In the developed model the horizon is 24 hours because the microgrid participates in its day-ahead market.  $S \in [1, 48]$  represents the current time period of the ongoing day. During one day, 48 half an hour time steps are simulated and in each, according to planning horizon, optimal state is specified. The solution to the optimization problem determines the power levels throughout the whole planning horizon considering the forecast uncertainty.

## 5.2 MPC model formulation

When introducing a stochastic element to the model, a range of error is defined for each forecasted data series. The bases for this were predictions from the deterministic model that were modified by random number generator of normal distribution with standard deviation linearly increasing with the distance from current time step. That way maximum error occurs at the end of planning horizon (24 hours ahead). Additionally, for PV production 10% possibility to lose 90% of current power was added. Figure 11 shows how the forecast error increases towards the end of planning horizon. Figure 12. depicts RES production for a single day.

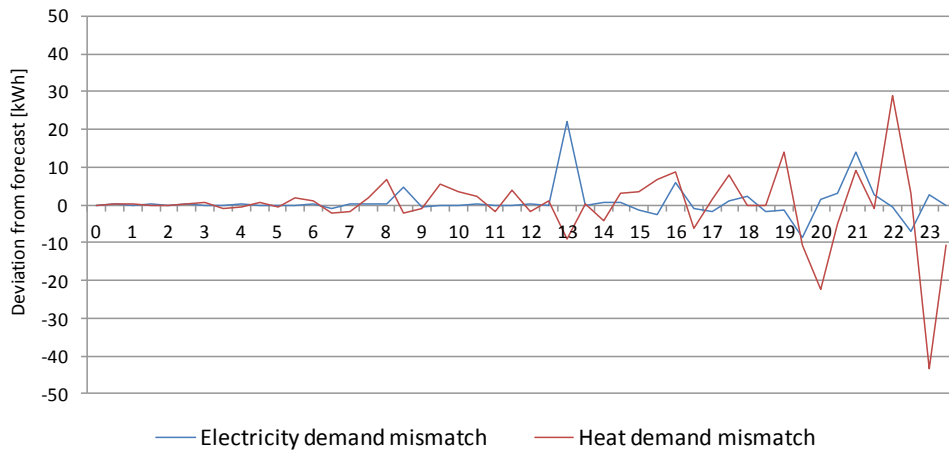

Figure 11. Mismatch between realized and forecasted heat and electricity production

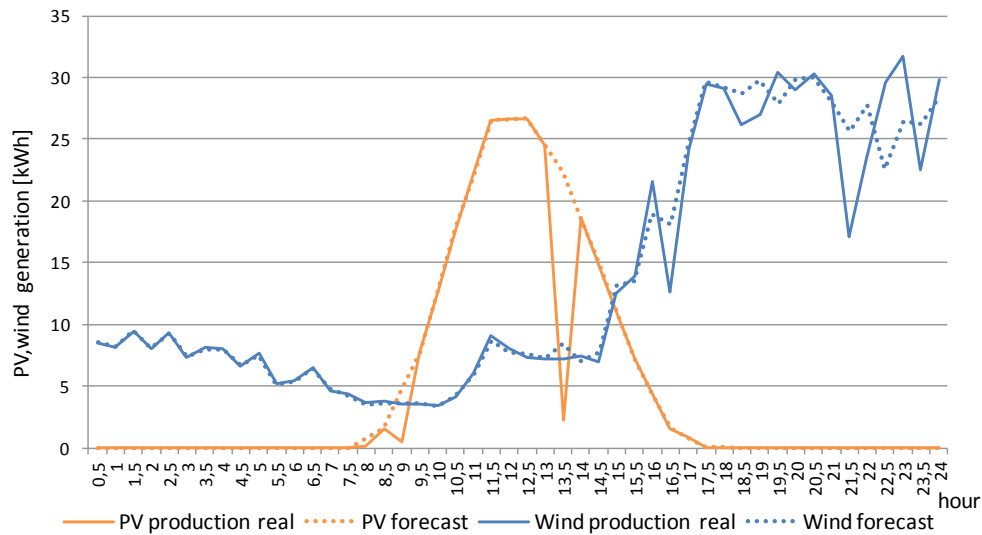

Figure 12. Forecasted and realized RES production for first planning horizon ( $S = 0$ )

Proposed microgrid operation is modelled in the following way:

1. Controller collects forecast data ( $E_d, H_d, E_{pv}, E_{wind}$ ) and estimates optimal microgrid operation. The planned import/export schedule is then sent to the distribution system operator (DSO);
2. In the first hour of the day controller acquires updated forecasts (for planning horizon) and accordingly deploys rolling unit commitment MPC model and adjusts control variables (operational set points of flexible units) to minimize operational cost. The mismatch from initially contracted exchange with the system is penalized;
3. In the next hour (next iteration) optimization is run again with updated forecast and planning horizon is shifted forward;
4. Step 2 and step 3 are repeated until the end of the day.

Additional cost, coming from the forecast error, can be divided in two main components: (i) mismatch compensation for not following the announced and contracted import/export schedule with the market; (ii) fuel cost increase (e.g. more frequent boiler use). Total cost function is updated as the rolling horizon moves to the end of the day, making adjustments

and taking into account the mismatch compensation for the realized periods and estimating costs from current hour till the end of the day (Equation 21). The final operational cost at the end of the day is calculated based on actual, adjusted operating points. Therefore objective function being minimized is:

$$\begin{aligned}
COST = & \sum_{t=1}^{24 \cdot \tau^{-1} - S} \left[ F(t) \cdot c_{ng} + E_{imp0}(t) \cdot c_{imp}(t) - E_{exp0} \cdot c_{exp}(t) + P \cdot E_{wind\_curt}(t) + P \cdot H_{waste}(t) \right] + \dots \\
& \dots + \left[ \begin{aligned} & (-)short_{imp}(t) \cdot (1-M) \cdot c_{exp}(t) + long_{imp}(t) \cdot (1+M) \cdot c_{imp}(t) + \\ & short_{exp}(t) \cdot (1+M) \cdot c_{imp}(t) - long_{exp}(t) \cdot (1-M) \cdot c_{exp}(t) \end{aligned} \right] + \dots \\
& \dots + \sum_{t=24 \cdot \tau^{-1} + 1 - S}^{24 \cdot \tau^{-1}} \left[ F(t) \cdot c_{ng} + E_{imp}(t) \cdot c_{imp}(t) - E_{exp} \cdot c_{exp}(t) + P \cdot E_{wind\_curt}(t) + P \cdot H_{waste}(t) \right]
\end{aligned} \tag{21}$$

$S$  marks how many iterations have passed from the start of the day,  $E_{imp0}, E_{exp0}$  mark scheduled import/export of EE. Variable  $short_{imp}$  is defined for negative mismatch in import,  $short_{exp}$  for negative mismatch in export,  $long_{imp}$  for positive mismatch in import and  $long_{exp}$  for positive mismatch in export. The planned exchange is based on day ahead market prices  $c_{imp}, c_{exp}$ . Differences resulting from microgrids incapability to balance the uncertainty and variability of RES are penalized by a percentage  $M$  reducing price for both import and export. Penalty percentage  $M$  used in the simulations is 25%.

### 5.3 Results of the model incorporating MPC

Total operating cost from the deterministic model is the reference value. MPC model achieves only 2% worse result (Figure 13.). Compared to the per-hour management where analysis is based solely on the state in the current hour and decisions are made not considering the future planning horizon MPC achieves 7% better results. To elaborate; if there was no microgrid controller capable of adjusting the operation of flexible units, the microgrid acts as a variable source from the system perspective. Incapable of communicating intra-day exchange with the system it constantly, throughout the day, creates an imbalance and practically acts as an uncontrollable market entity, very similar to RES units.

On secondary axis increase in total costs compared to the reference deterministic model is shown. Cumulatively costs with in case no MPC is used are increased 8%.

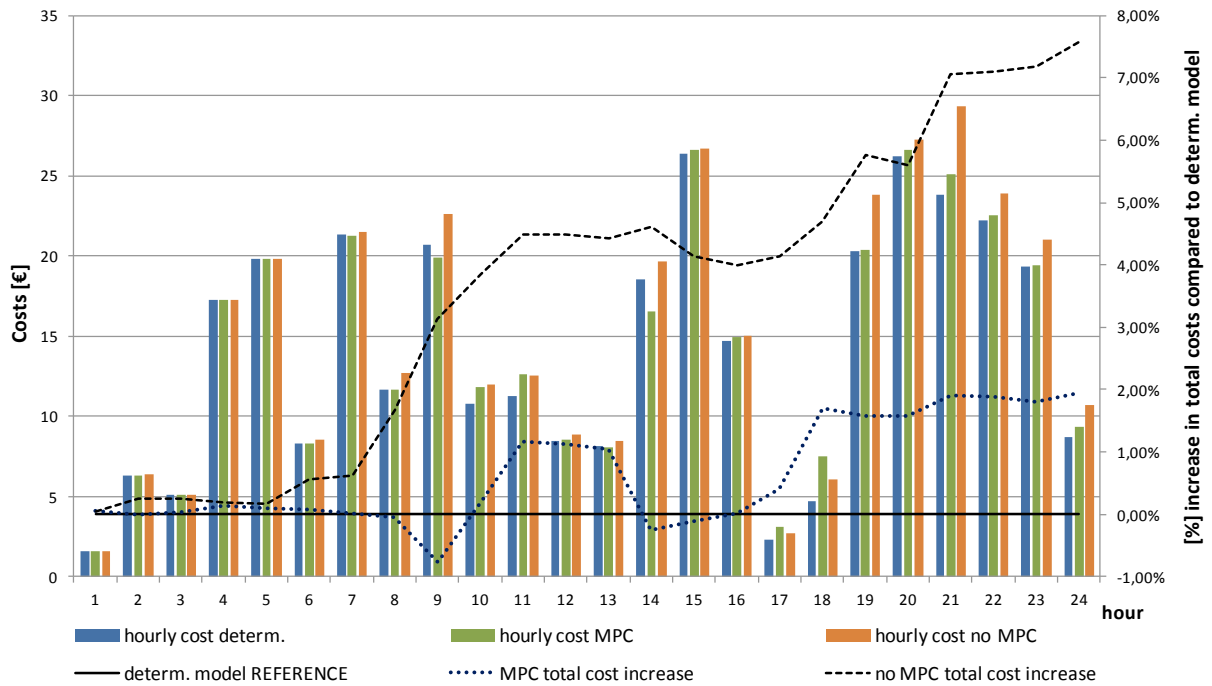

Figure 13.  $\mu$ CHP unit dispatch in the MPC model with and without heat storage

In case no MPC is implemented boiler unit needs to be used much more frequently to balance the heat demand (Figure 14.). It is important to note that MPC model also uses high penalty factor to inhibit the waste of energy.

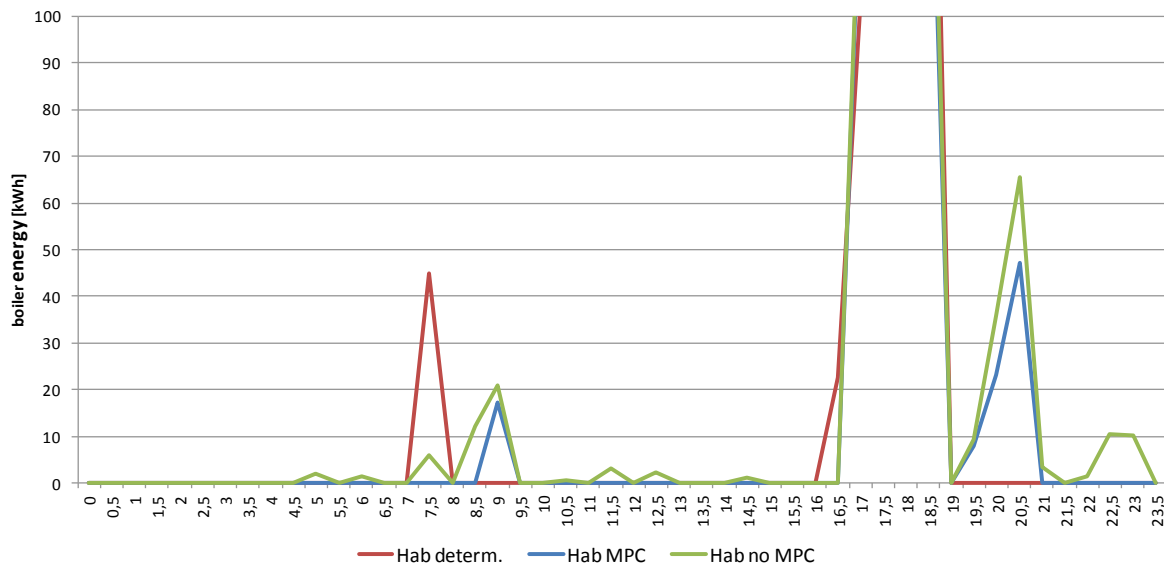

Figure 14. Boiler unit operation

To investigate if microgrid is capable to totally neutralize the RES forecast error penalty factor  $M$  was changed. The amounts of imported and exported energy were observed (Figure 15.) and their difference from planned values. The optimization problem was run 50 times for every value of  $M$  and averaged import and export values were taken.

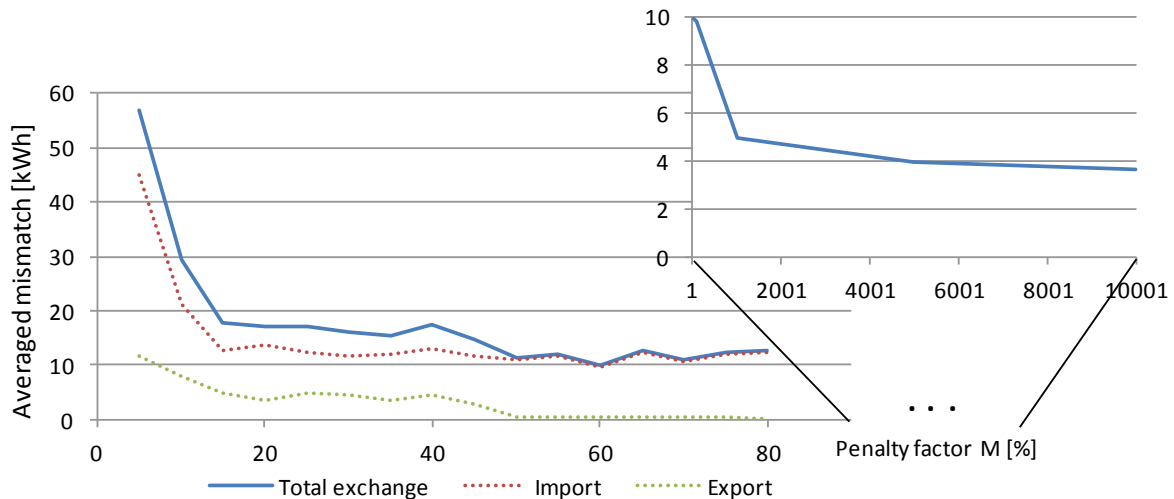

Figure 15. Averaged energy mismatch depending on the penalty factor

Already a small penalty factor reduces the amount of not planned exchange energy. Furthermore, imported part is smaller and can be reduced to 0 which means microgrid can more easily compensate surplus of energy produced by its components. Exported amount saturated around 10 kWh value which represents only 0,4% of daily used energy. Even with drastically increased penalty factors that totally inhibit the exchange of energy microgrid could not achieve perfect error compensation.

## 6. CONCLUSION AND FUTURE WORK

A novel concept based on MILP for modelling and optimization of microgrid operation has been presented. Deterministic model was developed to investigate what impact different units have on microgrids ability to operate in the off grid mode. It was shown that defining optimal sizes of installed wind and PV in a microgrid means very little of energy has to be wasted. Additionally, it was shown that capacity of heat storages and ratio of CHP to EHP units will units has bigger impact than flexible loads on the amount of wasted heat and curtailed wind.

To potentially compensate inevitable disturbances and forecast errors, model predictive control with rolling horizon was developed simulating market driven behaviour of system connected microgrid. The MPC strategy achieves better results (lower costs) than simple deterministic day ahead unit commitment strategy. It was shown that, with implemented MPC strategy, microgrid can almost totally balance the RES uncertainty by intraday adjustment of operational set points of flexible units.

Further work will focus on how a microgrid can achieve complete independence from distribution grid under stochastic framework. As it can be concluded from the work presented including battery storage systems seems to a valuable source of flexibility in off grid operation. However it should be taken into account that economics behind installing them only for energy arbitrage will not be sufficient to justify them. In term, more detailed model capable of addressing frequency flexibility is needed. Adding emissions and emissions cost to the model will also be one of the goals with a goal of defining decarbonisation potential of the microgrids.

## ACKNOWLEDGMENT

This work has been supported by the European Community Seventh Framework Programme under grant No. 285939 (ACROSS).

## REFERENCES

- [1] Hatziargyriou, N., Asano, H., Iravani, R. and Marnay, C., "Microgrids", *IEEE Power & Energy Magazine*, 2007.
- [2] E. R. Sanseverino, M. L. Di Silvestre, M. G. Ippolito, A. De Paola, G. Lo Re, "An execution, monitoring and replanning approach for optimal energy management in microgrids", *Energy*, vol. 36, pp. 3429-3436, Apr. 2011.
- [3] H. Pandzic, I. Kuzle, T. Capuder, "Virtual power plant mid-term dispatch optimization", *Applied Energy*, vol 101, pp. 134-141, 2011.
- [4] Molderink, A., Bakker, V., Bosman M., Hurink, J., and Smit, G., "On the effects of MPC on a domestic energy efficiency optimization methodology," *IEEE EnergyCon 2010.*, pp. 120-125, 2010
- [5] Wang, L., Wang, Z., Yang, R., "Intelligent multiagent control system for energy and comfort management in smart and sustainable buildings." *IEEE Trans Smart Grid*, vol 3, pp. 605-17., 2012
- [6] Basu, A., "Microgrids: Planning of fuel energy management by strategic deployment of CHP-based DERs - an evolutionary algorithm approach", *Electric Power and Energy Systems*, vol 44, pp.326-336., 2013
- [7] Malysz, P., Sirouspour, S., Emadi, A., "MILP-based Rolling Horizon Control for Microgrids with Battery Storage", *Industrial Electronics Society, IECON 2013*, pp. 2099-2104, 2013
- [8] Perković, L., Ban, M., Krajačić, G., Duić, N., "Receding horizon model predictive control for smart management of microgrids under the day-ahead electricity market", *SDEWES 2013 Conference, Dubrovnik, Croatia, 2013*
- [9] Marietta, M., Grealls, M., Guerrero, J. M., "A Rolling Horizon rescheduling Strategy for Flexible Energy in a Microgrid", presented at *IEEE Energycon 2014*
- [10] Parisio, A., Rikos, E., Tzamalīs, G., Glielmo, L., "Use of model predictive control for experimental microgrid optimization", *Applied Energy*, vol 115, pp. 37-46, 2014
- [11] Deng, Q., Gao, X., Zhou, H., and Hu, W., "System modeling and optimization of microgrid using genetic algorithm," *2nd Int. Conf. Intelligent Control and Information Processing*, pp. 540-544, 2011.
- [12] Ren, H, Gao, W., "Economic and environmental evaluation of micro CHP systems with different operating modes for residential buildings in Japan", *Energy and Buildings 2010*; vol 42., pp. 853-61.
- [13] Mancarella, P., "Cogeneration systems with electric heat pumps: Energy shifting properties and equivalent plant modelling", *Energy Conversion and Management, Vol 50*, pp. 1991-1999, 2009.
- [14] Arteconi, A., Hewwit, N.J., Polonara, F., "State of the art of thermal storage for demand side management", *Applied Energy, Vol 93*, pp. 371-389, 2012
- [15] "FICO Xpress", April 2014, [online - <http://www.fico.com/>]
- [16] "Demand Profile Generators", University of Strathclyde, April 2014, [online - <http://www.strath.ac.uk/esru/>]
- [17] "Egauge", April 2014, [online - [www.egauge.net/](http://www.egauge.net/)]
- [18] "EEX", April 2014, [online - [www.eex.com/](http://www.eex.com/)]

**Publication 7 - Beijing Subsidiary Administrative Center Multi- Energy Systems: An Optimal Configuration Planning – under review**

Huang, Wujing, Zhang, Ning, Kang, Chongqing, Capuder, Tomislav, Holjevac, Ninoslav, Kuzle, Igor, “Beijing Subsidiary Administrative Center Multi- Energy Systems: An Optimal Configuration Planning”, Electric Power System Research, 2019, under review, submitted March 2019.

- *9 pages*

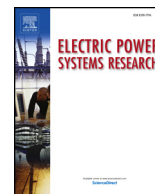

## Beijing subsidiary administrative center multi-energy systems: An optimal configuration planning



Wujing Huang<sup>a</sup>, Ning Zhang<sup>a,\*</sup>, Chongqing Kang<sup>a</sup>, Tomislav Capuder<sup>b</sup>, Ninoslav Holjevac<sup>b</sup>, Igor Kuzle<sup>b</sup>

<sup>a</sup> Department of Electrical Engineering, Tsinghua University, Beijing, China

<sup>b</sup> Faculty of Electrical Engineering and Computing, University of Zagreb, Zagreb, Croatia

### ARTICLE INFO

#### Keywords:

Configuration planning  
Energy hub  
Energy storage  
Multi-energy systems  
Operation simulation  
Renewable energy

### ABSTRACT

Multi-energy systems (MES) contribute to increasing energy utilization efficiency and renewable energy accommodation by coupling multiple energy sectors. Beijing is planning to build a subsidiary administrative center in Tongzhou District. A new MES will be built in this center from scratch to jointly meet electricity, heat and cooling demands. This raises the need for optimizing the configuration of MES from scratch at the planning stage. In this paper, the configuration planning of the MES in Beijing's new subsidiary administrative center is conducted using a two-stage mixed-integer linear programming (MILP) approach based on the energy hub (EH) model. Given the load demand, distributed renewable energy sources, energy prices and candidate system component parameters, the MES configuration planning, equipment selection and capacity planning are jointly managed without limiting the possibility of MES configuration. A sensitivity analysis is performed to show the impacts of load profiles and energy prices on the optimal MES configuration. Operation simulations are carried out based on the obtained optimal planning scheme and another four alternative planning schemes presented by Beijing subsidiary administrative center. The operating cost, CO<sub>2</sub> emission and overall system efficiency of each planning scheme are calculated and compared with each other.

### 1. Introduction

Beijing is planning to build a subsidiary administrative center in Tongzhou, a suburban district in the southeast of Beijing. According to the planning, Beijing municipal government will move from the current city center to this subsidiary administrative center. The new administrative center contains office buildings, commercial buildings and residential buildings covering an area of 6 square kilometers with the floor area of approximately 3.8 million square meters. A new multi-energy systems (MES) will be built in this center from scratch to jointly meet electricity, heat and cooling demands. An MES, in which electricity, fuels, heat, and cooling interact with each other, has obvious advantages compared with traditional energy systems in which energy sectors are treated independently: (1) An MES can accommodate more renewable energy using the flexibility from energy substitution (e.g., allowing heat loads supplied by electricity through EHPs) or from multiple types of energy storage systems. (2) An MES can increase the conversion efficiency and the utilization of primary energy sources including renewable energy sources [1,2].

The construction of the MES in Beijing's new subsidiary

administrative center raises the need for optimizing the configuration of MES from scratch at the planning stage. The configuration of MES denotes the choice of energy generation, conversion and storage equipment and the layout (connection relationships between pieces of individual equipment). MES configuration planning attempts to optimize the choice of equipment, how the pieces are connected, or both. MES configuration planning will majorly determine the cost effectiveness and the greenness of the energy system. Current research on MES configuration planning can be divided into two categories: (1) optimizing equipment size or type for a given MES configuration (planning using a given configuration) [3]. (2) Jointly optimizing the MES configuration and the equipment size or type (planning from scratch). The configuration planning problem of the second category is considered in this paper because the MES in the new subsidiary administrative center should be built from scratch.

To tackle the complex issue of the start from scratch planning model, several approaches have been proposed. Reference [4] presents an approach to optimize the values of elements in the energy hub (EH) coupling matrix rather than use a realistic MES configuration. In another group of approaches, a finite number of MES configurations are

\* Corresponding author.

E-mail address: [ningzhang@tsinghua.edu.cn](mailto:ningzhang@tsinghua.edu.cn) (N. Zhang).

<https://doi.org/10.1016/j.epsr.2019.106082>

Received 25 March 2019; Received in revised form 10 October 2019; Accepted 18 October 2019

Available online 13 November 2019

0378-7796/ © 2019 The Author(s). Published by Elsevier B.V. This is an open access article under the CC BY-NC-ND license (<http://creativecommons.org/licenses/by-nc-nd/4.0/>).



### Nomenclature

AB	Gas-fired auxiliary boiler
CCHP	Combined cooling, heat and power
CERG	Compression electric refrigerator group
CHP	Combined heat and power
CO <sub>2</sub>	Carbon dioxide
EDS	Electricity distribution system
EENS	Expected energy not supplied
EHP	Electric heat pump

ES	Battery
HS	Heat storage
COP	Coefficient of performance
CS	Cooling storage
DHN	District heating network
EB	Electric boiler
LOLP	Loss of load probability
PV	Photovoltaic system
WARG	Water absorption refrigerator group

chosen beforehand, and the operation strategy of each configuration is then optimized [5]. Other research narrows the optimization space of the planning problem by making some assumptions on the MES configuration [6,7]. In this research, the planning of the MES in Beijing's new subsidiary administrative center is conducted using a two-stage mixed-integer linear programming (MILP) approach based on the EH concept [8].

The remainder of the paper is structured as follows. Section 2 introduces the concept of EH layering. Section 3 describes the procedure of MES configuration planning from scratch. Section 4 introduces the basic information of Tongzhou. Section 5 shows the optimization results and sensitivity analysis of the configuration planning of the MES in Beijing's new subsidiary administrative center. Operation simulations are also carried out based on the obtained optimal planning scheme and another four alternative planning schemes presented by Beijing subsidiary administrative center in this section. Section 6 concludes the paper.

## 2. Energy hub layering

The EH concept was introduced as a tool for MES modeling in the project, "Vision of Future Energy Networks". An EH is described as a unit where multiple energy carriers can be converted, conditioned and stored. EHs consume energy at the input ports, which are connected to energy infrastructures from the upper transmission/distribution system (e.g., electricity and gas infrastructures), and provide required energy services (e.g., electricity, heat and cooling) at their output ports [9]. A typical EH is shown in Fig. 1. From the viewpoint of graph theory, the components of an MES (e.g., CHP, CERG, PV, HS and CS) can be seen as vertices, and the energy flows between these components can be seen as directed edges. The EH can therefore be modeled as a directed acyclic graph (DAG).

The configuration of EH can be analyzed using the topological layering of a DAG, in which the set of components is partitioned into subsets called layers. In a layered EH, the set of layers is ordered and each energy flow in EH is directed from a lower layer to a higher layer [10]. Fig. 2 demonstrates the topological layering of the EH shown in Fig. 1. In the layered EH, the energy flow that connects two adjacent layers is called short edge, otherwise it is called long edge [11]. To avoid long edges in the modeling of the EH, placeholder connection components are added to divide long edges into several short edges in this research. In Fig. 2, placeholder connection components have been added.

To model the EH configuration, an  $m \times n$  matrix  $\mathbf{Y}$  is proposed as shown in (1), where  $m$  denotes the number of layers and  $n$  denotes the total number of system components.

$$\mathbf{Y} = \begin{pmatrix} y_{11} & \cdots & y_{1n} \\ \vdots & \ddots & \vdots \\ y_{m1} & \cdots & y_{mn} \end{pmatrix} \quad (1)$$

All elements in matrix  $\mathbf{Y}$  are binary variables:  $y_{ij} = 1$  if system component  $j$  is in layer  $i$  of the EH; otherwise,  $y_{ij} = 0$ . Layering of the EH can be uniquely determined by matrix  $\mathbf{Y}$ .

## 3. MES configuration planning

Based on the concept of EH layering, the procedure for MES configuration planning from scratch can be divided into two stages: (1) optimizing the investment decision on what system components should be invested in for each layer of the EH. (2) Optimizing the connection relationships between the invested system components in each two adjacent layers of the EH.

The stage I aims at jointly minimizing the investment cost and operational cost of the MES. The equivalent annualized investment cost of EH components and distribution transformer capacity is considered. The annual operation cost is calculated according to the energy purchased from the energy distribution system and it is approximated by the weighted sum of several operation scenarios based on their probabilities. The method of scenario reduction based on cluster analysis is utilized to reduce the calculation while guaranteeing the representativeness of scenarios. Scenarios include load scenarios, energy price scenarios and renewable energy output scenarios to fully account for the diversity of system operation conditions.

It should be noted that the efficiency of each system component is affected by its operating condition or environment. The non-constant efficiency makes the first stage problem a MINLP problem. Reference [12] has shown that although the simplification of efficiency would bring a different operation decision, the approximation does not have significant impact on the estimation of the long term operational cost. At the planning stage, constant efficiencies are sufficient for modeling system components. In this regard, the first stage problem becomes a MILP problem.

Optimization results of the first stage problem provide planning decisions for system components in each layer. The connection relationship between each two adjacent layers is optimized during the second stage. The main idea behind the optimization is to first connect each pair of input/output ports pertaining to the same energy type and then cut the redundant directed edges. Stage II aims to find the optimal connection between the system components while maintaining the feasibility and optimality of the optimization results obtained in stage I. The mathematical model of stage II is also a MILP problem.

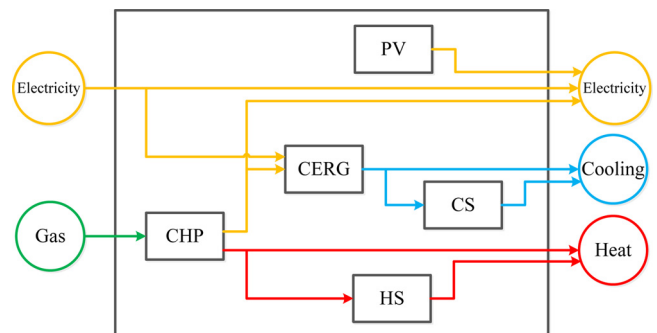

Fig. 1. Energy hub.

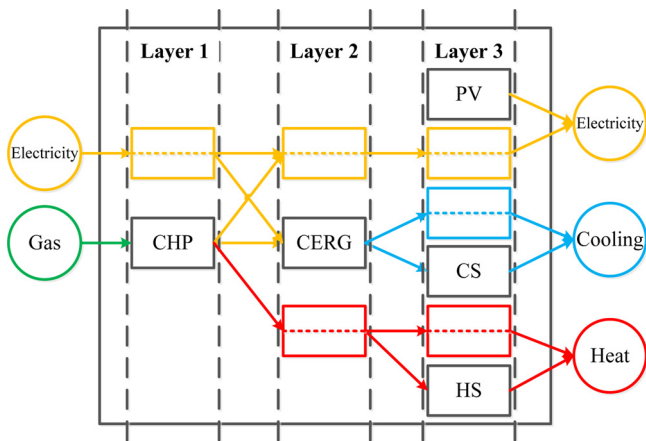

Fig. 2. Layered energy hub.

4. Basic information of Tongzhou

Tongzhou is in the southeast of Beijing as shown in Fig. 3 and the new subsidiary administrative center covers an area of 6 square kilometers with the floor area of approximately 3.8 million square meters.

Basic information of Tongzhou, including load demand, information of distributed renewable energy sources (DRES), energy price and candidate system component parameters, is introduced as follows.

Heat and cooling demands are estimated by calculating the difference between indoor and outdoor temperatures. Beijing municipal

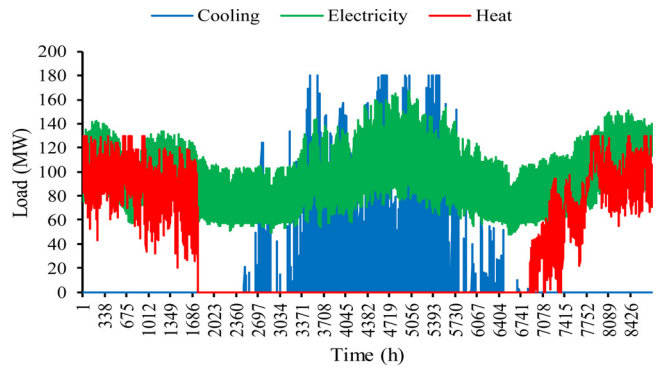

Fig. 4. Projected hourly electricity, heat and cooling demands in Tongzhou subsidiary administrative center in the planning year.

government has set up regulation requiring that the indoor temperature cannot be lower than a threshold temperature 18 °C during the heating period. Therefore, the heat demand is estimated by calculating the difference between the outdoor ambient temperature and 18 °C when the ambient temperature is lower than 18 °C. The cooling demand is calculated similarly assuming that there is a need for cooling when the outdoor ambient temperature is above 26 °C. The hourly ambient temperature is extracted from GEOS-5 and is averaged for the area of subsidiary administrative center using the temperature at the 2 m above the ground in each grid cell [13]. The hourly ambient temperature in 2016 is used to represent the temperature in the planning year. Thus, the heat and cooling demands are calculated by the hourly ambient



Fig. 3. Location of Tongzhou District in Beijing.

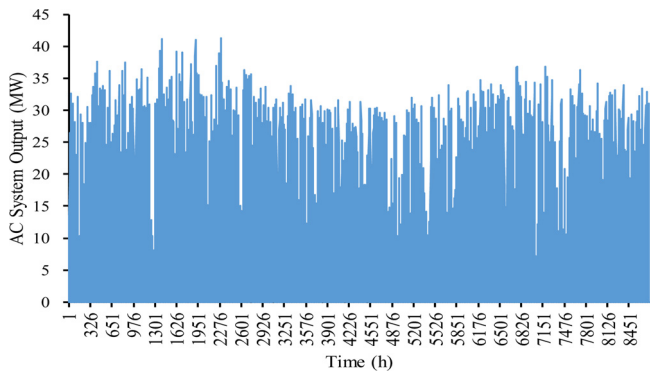

Fig. 5. Annual PV system output data in Beijing.

temperature in 2016. The electricity demand is estimated according to the forecasted maximum load (167.6 MW). Electricity, heat and cooling demands in Tongzhou subsidiary administrative center are shown in Fig. 4, in which heating and cooling season can be easily distinguished.

Concerning the DRES, we take into account the possibility of taking roof PV system as one of the alternative energy resources of the subsidiary administrative center besides the main grid electricity (which is mainly coal based electricity). The maximum potential capacity of the roof PV systems is approximately 46.5 MW, considering the roof area of 380,000 m<sup>2</sup> and the 160 W/m<sup>2</sup> PV modules. The hourly PV system output data in Beijing obtained from the National Renewable Energy Laboratory (NREL) is shown in Fig. 5.

Utilizing the method of scenario reduction, load scenarios and PV component output scenarios are characterized by different patterns for nine selected days in the summer, intermediate and winter seasons with corresponding scenario probabilities. The selected representative load

Table 1

Probabilities of the selected representative scenarios in Tongzhou Subsidiary Administrative Center.

Scenario	Probability	Scenario	Probability	Scenario	Probability
1	0.1115	4	0.3088	7	0.1223
2	0.0815	5	0.1448	8	0.0805
3	0.0570	6	0.0464	9	0.0473

scenarios and PV component output scenarios in Tongzhou subsidiary administrative center and the corresponding scenario probabilities are shown in Fig. 6 and Table 1 respectively.

The price of industrial and commercial gas in Beijing is 3.16 yuan/m<sup>3</sup>. Considering the heating value of gas is approximately 38 MJ/m<sup>3</sup>, the price of industrial and commercial gas in Beijing can be set at 300 yuan/MWh and is considered constant during the yearly analysis period. The price of electricity in Beijing is time-based and can be divided into peak, flat and valley time prices (1322.2 yuan/MWh, 839.5 yuan/MWh, and 381.8 yuan/MWh respectively). In summer, the critical peak price (1440.9 yuan/MWh) is applied to three hours each day during 11:00–13:00 and 20:00–21:00 [13]. The curve of electricity price in Tongzhou subsidiary administrative center is shown in Fig. 7. No thermal/cooling power is directly purchased from outside of the subsidiary administrative center; therefore, the heat/cooling demand should be satisfied by the energy converters in the MES.

The technological and economic parameters of candidate system components, including energy efficiency, rated capacity, investment cost and lifetime, are listed in Table 2 [7,14,15]. Discount rate is set at 10%. Besides, the investment cost of distribution transformer is 32 yuan/(kW-month).

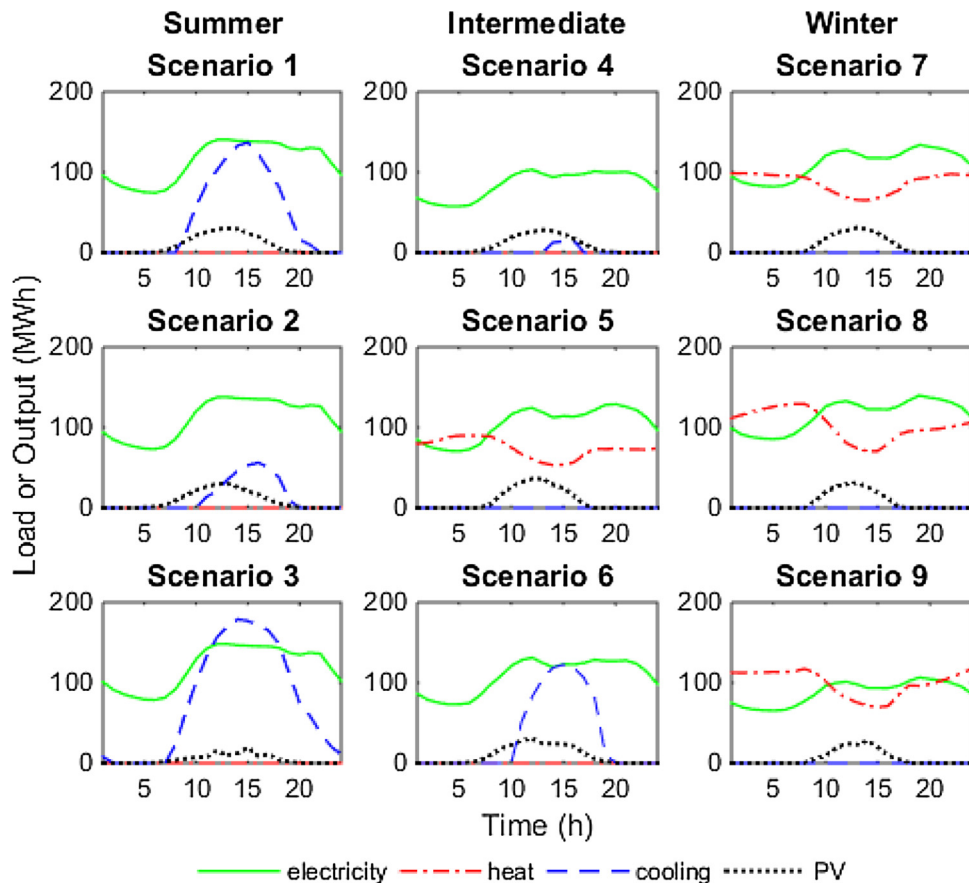

Fig. 6. The selected representative load scenarios and PV component output scenarios in Tongzhou subsidiary administrative center.

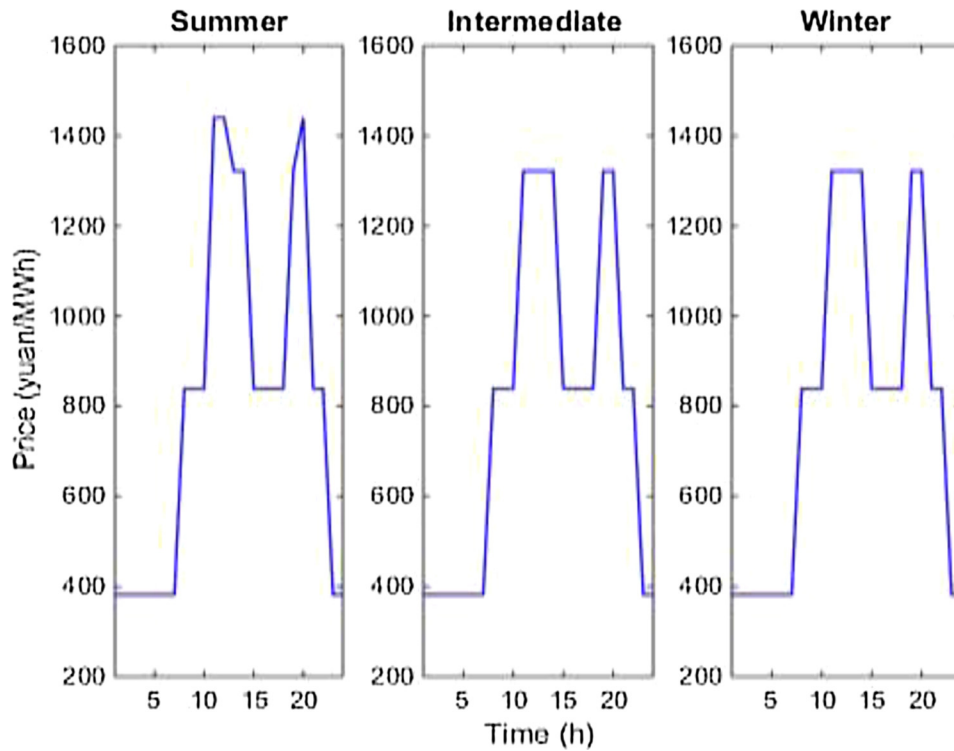

Fig. 7. The curve of electricity price in Tongzhou subsidiary administrative center.

**Table 2**  
Technological and economic parameters of candidate system components.

	Energy efficiency	Unit size capacity	Investment cost <sup>a</sup>	Lifetime (year)	Total number
CHP	El: 0.3 Therm: 0.45	El: 30 MW Therm: 45 MW	7900 yuan/kW	30	6
AB	0.8	20 MW	851 yuan/kW	20	6
CERG	3	40 MW	1200 yuan/kW	20	6
WARG	0.7	20 MW	1228 yuan/kW	20	6
EB	0.9	20 MW	1200 yuan/kW	20	6
EHP	2	30 MW	1200 yuan/kW	20	6
ES	Char./ Disch.: 0.75	10 MW 30 MWh	1782 yuan/kWh	13.5	6
HS	Char./ Disch.: 0.9	6 MW 90 MWh	90 yuan/kWh	20	6
CS	Char./ Disch.: 0.65	3 MW 45 MWh	190 yuan/kWh	20	6
PV	-	15.5 MW	7215 yuan/kW	30	3

<sup>a</sup> Approx. exchange rates: 1 USD = 6.40 CNY, 1 EUR = 7.56 CNY.

## 5. Optimization results and sensitivity analysis

### 5.1. Optimization results

In this study, the MATLAB toolbox YALMIP with the Gurobi solver is used to conduct the MES configuration planning. The optimization result of the MES configuration planning is presented in Fig. 8.

As the optimization result shows, 60 MW CHP, 30 MW EHP, 40 MW CERG, 80 MW WARG, 360 MWh HS, 135 MWh CS and 46.5 MW PV system were chosen as the optimal planning scheme. The electricity demand is satisfied by the purchased electricity, CHP and roof PV system. All roofs were suggested to install PV system because of their low operational cost and low investment cost in China today. Heat demand is satisfied by CHP and EHP. Cooling demand is satisfied by WARG and CERG. CHP and WARG were chosen to avoid purchasing a lot of electricity to meet the demand during peak and flat times. In

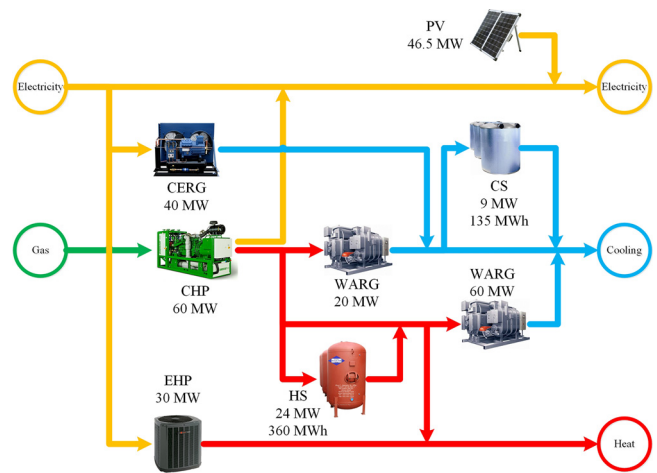

Fig. 8. Optimization result of MES configuration planning.

addition, heat/cooling storage systems were chosen to reduce the heat/cooling cost.

### 5.2. Sensitivity analysis

A sensitivity analysis was performed on the load profiles and energy prices to show the impact of the change of boundary conditions on the investment decision.

#### 5.2.1. Load profiles

In the following analysis, the relative ratio between heat/cooling demand and electricity demand is changed while maintaining the overall energy demand constant. The heat-to-electric ratio is used to present the ratio between heat/cooling demand and electricity demand. Table 3 shows the different investment decisions corresponding to different multipliers for the heat-to-electric ratio. When the multiplier for the heat-to-electric ratio is as low as 0.5, a smaller CHP is selected

**Table 3**  
Different investment decisions resulting from different multipliers for the heat-to-electric ratio.

Multiplier	CHP (MW)	EHP (MW)	CERG (MW)	WARG (MW)	ES (MWh)	HS (MWh)	CS (MWh)
0.25	30	30	0	80	30	360	45
0.5	30	30	40	40	30	180	0
0.75	60	30	40	80	0	540	0
1	60	30	40	80	0	360	135
1.25	60	30	40	120	0	450	135
1.5	60	60	80	100	0	360	45
1.75	60	60	80	100	0	450	0

**Table 4**  
Different investment decisions resulting from different multipliers for the gas price.

Multiplier	CHP (MW)	EHP (MW)	CERG (MW)	WARG (MW)	HS (MWh)	CS (MWh)
0.6	90	0	40	120	540	270
0.7	90	30	40	120	540	270
0.8	60	30	40	100	450	270
0.9	60	30	40	100	360	225
1	60	30	40	80	360	135
1.1	60	30	40	80	360	45
1.3	30	60	40	80	540	45

because of the decreasing heat/cooling demand. Battery is selected to compensate for the reduced CHP capacity. No CERG is selected when the multiplier is as low as 0.25. When the multiplier for the heat-to-electric ratio is as high as 1.5, EHP and CERG with larger capacity are selected because of the increasing heat/cooling demand. The total size

of heat/cooling storage system changes following almost the same trend as the capacity of WARG changing. The size of PV system is always 46.5 MW when the multiplier ranges from 0.25 to 1.75.

5.2.2. Energy prices

Table 4 shows the different investment decisions resulting from the price of gas with different multipliers. When the price of gas reduces to 210 yuan/kWh, larger CHP is selected to generate electricity and produce heat with low operational cost. When gas price reduces to 180 yuan/kWh, EHP is not chosen and the heat is totally produced by CHP. The amount of heat produced by CHP increases with the gas price reducing from 330 yuan/kWh to 180 yuan/kWh; consequently, the size of WARG and HS increase from 80 MW and 360 MWh to 120 MW and 540 MWh respectively. Correspondingly, the size of CS increases from 45 MWh to 270 MWh to cooperate with the larger WARG. CHP with smaller capacity is chosen when the price of gas increases to 390 yuan/kWh. Similarly, the size of PV system is always 46.5 MW when the multiplier ranges from 0.6 to 1.3.

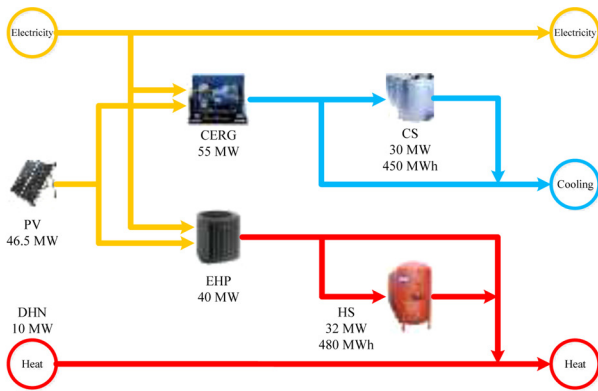

(a) Alternative planning scheme 1 (Focus: PV+HS/CS)

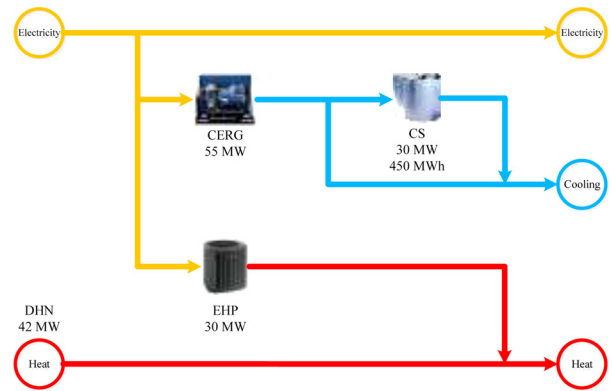

(b) Alternative planning scheme 2 (Focus: DHN)

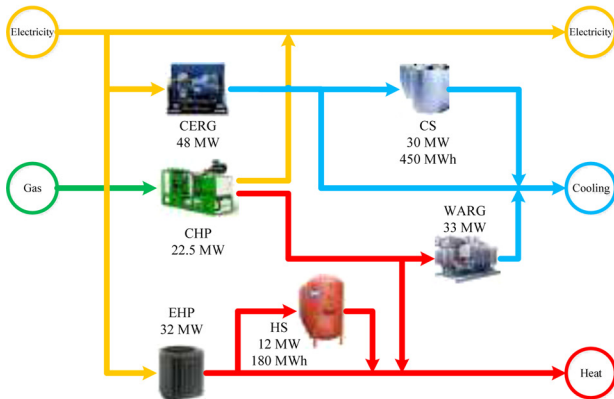

(c) Alternative planning scheme 3 (Focus: CCHP)

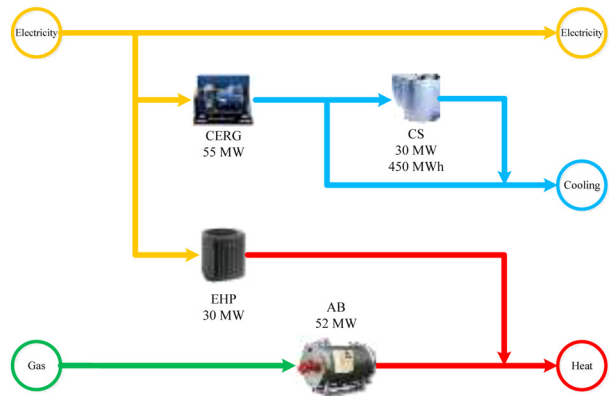

(d) Alternative planning scheme 4 (Focus: AB)

Fig. 9. MES configurations of the alternative planning scheme 1–4 presented by Beijing subsidiary administrative center.

**Table 5**  
Annual operating costs of different planning schemes.

Cost (million yuan)	Optimal planning scheme	Alternative planning scheme 1	Alternative planning scheme 2	Alternative planning scheme 3	Alternative planning scheme 4
Energy cost	696	810	848	823	863
Capacity cost	63	82	85	74	85
Operating cost	759	892	933	897	948

**Table 6**  
Electricity, heat and cooling sources of different planning schemes.

Sources	Optimal planning scheme	Alternative planning scheme 1	Alternative planning scheme 2	Alternative planning scheme 3	Alternative planning scheme 4
Electricity	EDS CHP PV	EDS PV	EDS	EDS CHP	EDS
Heat	EHP HS CHP	EHP HS DHN	EHP DHN	EHP HS CHP	EHP AB
Cooling	CERG CS WARG	CERG CS	CERG CS	CERG CS WARG	CERG CS

### 5.3. Operation simulation

In this part, operation simulations are carried out based on five planning schemes, i.e., the obtained optimal planning scheme as shown in Fig. 8 and another four alternative planning schemes presented by Beijing subsidiary administrative center. These five planning schemes are named optimal planning scheme and alternative planning scheme 1–4, respectively. In addition, the operating cost, CO<sub>2</sub> emission and overall system efficiency of each planning scheme are calculated and compared with each other.

#### 5.3.1. Basic settings

The specific MES configurations of the alternative planning scheme 1–4 presented by Beijing subsidiary administrative center are shown in Fig. 9. These four alternative planning schemes have different focuses:

**Alternative planning scheme 1:** using the PV-generated electricity to produce thermal/cooling power and using the HS/CS to cooperate.

**Alternative planning scheme 2:** purchasing heat from the DHN.

**Alternative planning scheme 3:** using the CCHP, i.e., the CHP and the WARG.

**Alternative planning scheme 4:** using the AB to produce heat.

The annual hourly electricity, heat and cooling demands as shown in Fig. 4, the annual PV system output data as shown in Fig. 5, the curve of electricity price as shown in Fig. 7 and the parameters of the system components as shown in Table 2 are used to perform the operation simulations. The price of gas is also set at 300 yuan/MWh and is considered constant during the yearly analysis period. It is supposed that half of the heat purchased from the DHN comes from burning gas and the other half comes from burning coal. As a result, the price of the purchased heat is set at 201.6 yuan/MWh and is also considered constant during the yearly analysis period.

#### 5.3.2. Operating cost

The annual operating costs, including energy costs and capacity costs, of different planning schemes are summarized in Table 5. The energy costs are caused by purchasing electricity, heat and gas from the distribution systems and the capacity costs are caused by the investment of distribution transformers. The installed capacity of the distribution transformer is determined by its potential peak load.

As shown in Table 5, the optimal planning scheme leads to a lowest

annual energy cost and a lowest annual capacity cost, which further results in a lowest annual operating cost. The alternative planning scheme 1 leads to a relatively low energy cost because the investment of PV can help to reduce the amount of the purchased electricity. The alternative planning scheme 3 also leads to a relatively low operating cost because the gas-fired CHP contributes to avoiding purchasing a lot of electricity during the peak times of the electricity price and significantly reducing the installed capacity of the distribution transformer. The alternative planning scheme 2 and alternative planning scheme 4 both lead to a relatively high operating cost which indicates that neither purchasing heat from the DHN nor producing heat by the AB is a cost-effective way to meet the base load.

#### 5.3.3. Operation pattern

The electricity, heat and cooling sources of different planning schemes are summarized in Table 6.

The operation patterns (i.e., how the demands are satisfied) under the summer and winter representative load scenarios (i.e., the scenario 3 and scenario 8 shown in Fig. 6) and different planning schemes is shown in Fig. 10. Several remarks can be made according to Fig. 10: (1) For the optimal planning scheme, there is not a single source playing a dominant role in satisfying the demands. The CHP mainly works during the peak and flat times of the electricity price while the EHP mainly works during the valley times. The HS stores the heat produced by the CHP and discharges it after the CHP shuts down. (2) For the alternative planning scheme 1–4, the cooling demand is mainly satisfied by the CERG. The HS stores heat produced by the EHP during the valley times of the electricity price and discharge it during the peak times, which is different from that of the optimal planning scheme. (3) The CHP in the alternative planning scheme 4 should work during the valley times of the electricity price because the HS charges thermal power instead of discharging power at these times. (4) The CS discharges cooling power during the peak times of both the electricity price and the cooling demand in all of the five planning schemes. (5) The AB only works when the heat demand exceeds the capacity of the EHP and the electricity price reaches its peak, which also indicates that the AB is not a cost-effective choice for heat supply.

#### 5.3.4. CO<sub>2</sub> emission and overall system efficiency

Given that the CO<sub>2</sub> emissions of the purchased electricity, gas and heat are 890 kg/MWh, 186.2 kg/MWh and 266.8 kg/MWh respectively, the purchased electricity is the major source of the CO<sub>2</sub> emission. The annual CO<sub>2</sub> emissions of different planning schemes are calculated and shown in Table 7. The investments of the CHP and PV both contribute to a reduction in the amount of the purchased electricity, which results in a lowest CO<sub>2</sub> emission for the optimal planning scheme. The alternative planning scheme 1 and alternative planning scheme 3 also lead to relatively low CO<sub>2</sub> emissions for a similar reason.

The efficiency of energy utilization is evaluated by the overall system efficiency, i.e., dividing the total annual demand (including electricity, heat and cooling demands) by the total annual energy input (including the purchased electricity, gas, heat and the PV-generated electricity). The overall system efficiencies of different planning schemes are also calculated and shown in Table 7. The COPs of the CERG and EHP are both greater than 100%; as a result, the alternative planning scheme 1 with the largest CERG and EHP has a highest overall

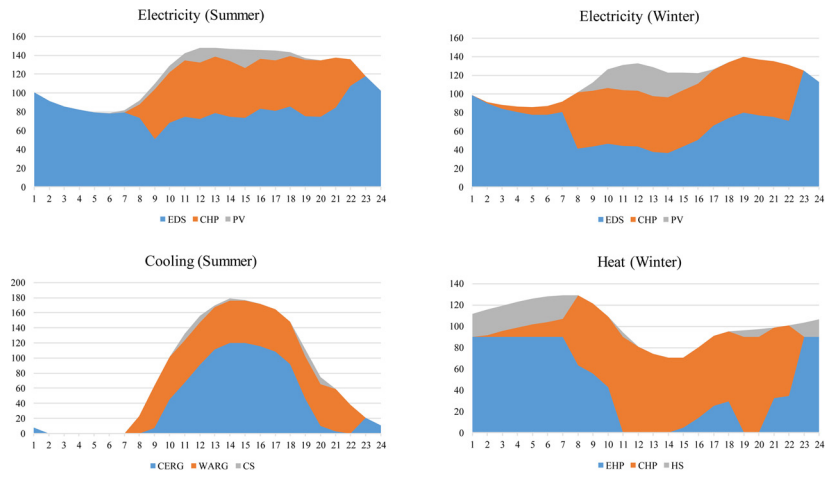

(a) Operation patterns under the optimal planning scheme

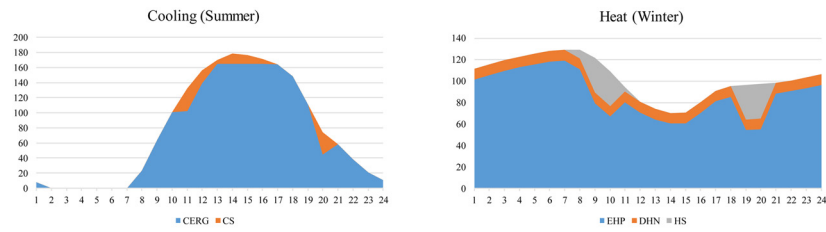

(b) Operation patterns under the alternative planning scheme 1

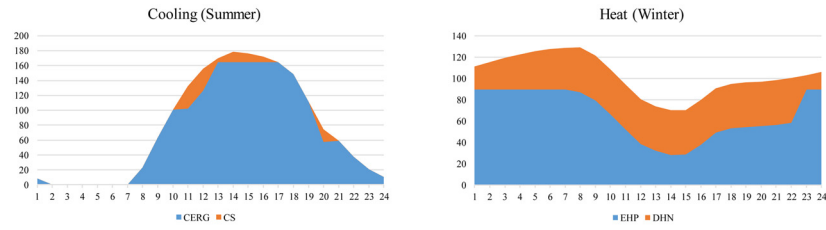

(c) Operation patterns under the alternative planning scheme 2

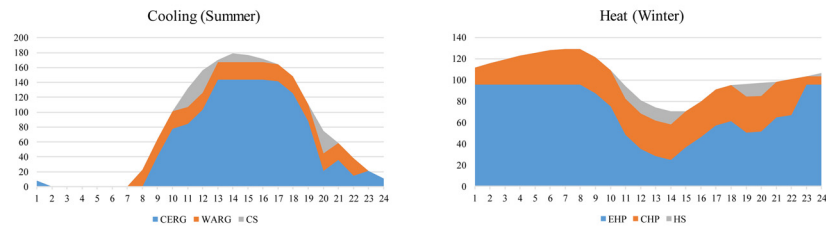

(d) Operation patterns under the alternative planning scheme 3

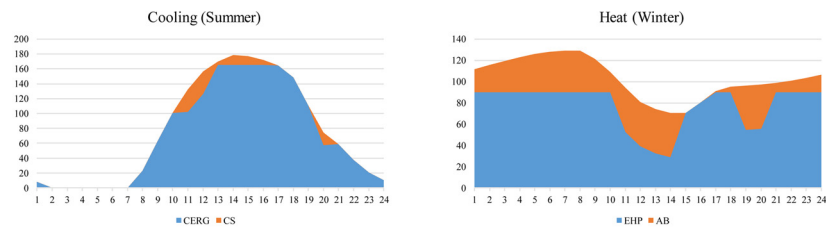

(e) Operation patterns under the alternative planning scheme 4

Fig. 10. Operation patterns under the summer and winter representative load scenarios and different planning schemes.

**Table 7**  
Annual CO<sub>2</sub> emissions and overall system efficiencies of different planning schemes.

	Optimal planning scheme	Alternative planning scheme 1	Alternative planning scheme 2	Alternative planning scheme 3	Alternative planning scheme 4
Emission (million kg)	726	872	907	854	906
Efficiency (%)	94	124	118	109	119

system efficiency. The overall system efficiency of the optimal planning scheme is relatively low; nevertheless, it is 94% which is very close to 100%. The optimal planning scheme has a lowest operating cost but not a highest overall system efficiency, which shows that the economy and efficiency are not the same objective in certain cases, especially for the optimization of MES.

#### 5.4. Discussion

The climate of some cities in different countries, e.g., some European cities, is similar to that of Beijing; therefore, the load patterns of them are also similar. The obtained results can be further applied and extended to these European cities: (1) The roof PV system is a cost-efficient choice and its output power can be fully accommodated when PV penetration reaches 27%. (2) 35% of electricity load and 31% of cooling load are suggested to be satisfied by CHP and WARG, respectively, to avoid purchasing a lot of high price electricity in peak times. (3) 18% of heat load is suggested to be satisfied by heat storage system after the CHP shuts down, which reduces operating cost by using surplus heat produced by CHP. (4) The sizes of CHP, WARG and heat/cooling storage system can be increased according to the sensitivity analysis if the gas price in European cities is lower than that in Beijing.

#### 6. Conclusion

The configuration planning of the MES in the Beijing's new subsidiary administrative center is conducted using a two-stage MILP approach based on the EH concept. Given the load demand, distributed renewable energy sources, energy prices and candidate system component parameters, the MES configuration planning, equipment selection and capacity planning are jointly managed without limiting the possibility of MES configuration. The optimal energy supply configuration of such typical city energy system in north China is obtained and analyzed. In such system, electricity is supplied by coal based main grid electricity, CHP and roof PV system. All roofs were suggested to install PV system because of their low operational cost and low investment cost in China today. Heat is supplied by CHP, EHP and heat storage. Cooling demand is suggested to be satisfied by WARG, CERG and cooling storage. CHP and WARG mainly work in peak and flat times to avoid purchasing high price electricity. Heat/cooling storage systems are chosen to reduce the heat/cooling cost through peak-valley electricity price difference. Sensitivity analysis shows that larger EHP and CERG are chosen when heat/cooling demand increases and smaller CHP is chosen when heat/cooling demand decreases. Moreover, the sizes of CHP, WARG and heat/cooling storage system increase with the gas price decreasing. Operation simulations are carried out based on the obtained optimal planning scheme and another four alternative planning schemes presented by Beijing subsidiary administrative center. The operating cost, CO<sub>2</sub> emission and overall system efficiency of each planning scheme are calculated and compared with each other. The results show that the obtained optimal planning scheme has obvious

advantages in the aspects of economy and emission.

#### Declaration of Competing Interest

The authors declare that they have no known competing financial interests or personal relationships that could have appeared to influence the work reported in this paper.

#### Acknowledgements

This work was supported in part by China-Croatia Inter-Governmental S&T Cooperation Project Flexible Urban systems in mUlti-eneRgy Environment – FUTURE, the Major Smart Grid Joint Project of National Natural Science Foundation of China and State Grid (No. U1766212) and EU-CHINA Research and Innovation Partnership project Instigation of Research and Innovation Partnership on Renewable Energy, Energy Efficiency and Sustainable Energy Solutions for Cities (IRES-8), contract number ICI+/2014/347-910.

#### References

- [1] P. Mancarella, MES (multi-energy systems): an overview of concepts and evaluation models, *Energy* 65 (February) (2014) 1–17.
- [2] T. Capuder, P. Mancarella, Techno-economic and environmental modelling and optimization of flexible distributed multi-generation options, *Energy* 71 (July) (2014) 516–533.
- [3] E.A.M. Ceseña, T. Capuder, P. Mancarella, Flexible distributed multienergy generation system expansion planning under uncertainty, *IEEE Trans. Smart Grid* 7 (January (1)) (2016) 348–357.
- [4] M. Geidl, G. Andersson, Operational and Topological Optimization of Multi-carrier Energy Systems, Presented at Proc. Int. Conf. Future Power Syst. (FPS), (2005) November.
- [5] R. Ooka, K. Komamura, Optimal design method for building energy systems using genetic algorithms, *Build. Environ.* 44 (July) (2009) 1538–1544.
- [6] E. Fabrizio, V. Corrado, M. Filippi, A model to design and optimize multi-energy systems in buildings at the design concept stage, *Renew. Energy* 35 (March (3)) (2010) 644–655.
- [7] Z. Zhou, P. Liu, Z. Li, W. Ni, An engineering approach to the optimal design of distributed energy systems in China, *Appl. Therm. Eng.* 53 (May) (2013) 387–396.
- [8] W. Huang, N. Zhang, J. Yang, Y. Wang, C. Kang, Optimal configuration planning of multi-energy systems considering distributed renewable energy, *IEEE Trans. Smart Grid* 10 (March (2)) (2019) 1452–1464.
- [9] M. Geidl, G. Koepf, P. Favre-Perrod, B. Klockl, G. Andersson, K. Frohlich, Energy hubs for the future, *IEEE Power Energy Mag.* 5 (January/February (1)) (2007) 24–30.
- [10] J. Warfield, Crossing theory and hierarchy mapping, *IEEE Trans. Syst. Man Cybern. SMC-7* (July (7)) (1977) 505–523.
- [11] P. Eades, K. Sugiyama, How to draw a directed graph, *J. Inf. Process.* 13 (4) (1990) 424–434.
- [12] N. Holjevac, T. Capuder, N. Zhang, I. Kuzle, C. Kang, Corrective receding horizon scheduling of flexible distributed multi-energy microgrids, *Appl. Energy* 207 (December) (2017) 176–194.
- [13] Y. Wang, N. Zhang, Z. Zhuo, C. Kang, D. Kirschen, Mixed-integer linear programming-based optimal configuration planning for energy hub: Starting from scratch, *Appl. Energy* 210 (January) (2018) 1141–1150.
- [14] G. Chicco, P. Mancarella, Matrix modelling of small-scale trigeneration systems and application to operational optimization, *Energy* 34 (March (3)) (2009) 261–273.
- [15] F. Lv, H. Xu, S. Wang, National survey report of PV power applications in China – 2016, IEA Photovoltaic Power System Programme, October, 2017 Available: [http://iea-pvps.org/index.php?id=93&elD=dam\\_frontend\\_push&docID=4107](http://iea-pvps.org/index.php?id=93&elD=dam_frontend_push&docID=4107).



---

**LIST OF ABBREVIATIONS**

AB	Auxiliary Boiler
BEES	Battery electrical energy storage
CCHP	Combined Cooling, Heat and Power (trigeneration)
CCHP	Combined Cooling Heat and Power
CHP	Combined Heat and Power
COP	Coefficient of Performance
DSO	Distribution System Operator
EHP	Electric Heat Pump
EV	Electric Vehicles
KKT	Karush-Kuhn-Tucker conditions
$\mu$ CHP	Micro Combined Heat and Power
MEM	Multi-energy Microgrid
MES	Multi-energy System
MILP	Mixed Integer Linear Programming
MPC	Model Predictive Control
MPEC	Mathematical Program with Equilibrium Constraints
PV	Photovoltaic
RES	Renewable Energy Sources
RH-CSA	Receding Horizon Corrective Scheduling Algorithm
TES	Thermal Energy Storage
VPP	Virtual Power Plant
WPP	Wind power plant
WT	Wind turbine

## LIST OF FIGURES AND TABLES

### FIGURES:

Figure 2.1 Schematic illustration of the multi-service perspective. Figure adapted from [5]....	7
Figure 2.2 Example of multi-generation system simplified scheme for trigeneration of electricity, heating and cooling and network interactions .....	7
Figure 2.3 Power system flexibility planning process – traditional process (in orange) and modified process (in green). Figure adapted from [43].....	10
Figure 3.1 Microgrid physical and communication structure showing energy flows with full lines and information and control flows with dashed. Figure adapted from [65]. .....	14
Figure 3.2 Optimization framework utilizing the hierarchical control of two layers .....	15
Figure 3.3 Piecewise linear approximation of the fuel cost function. ....	17
Figure 3.4 Illustration of the KKT conditions for the case of one inequality constraint in the bidimensional space. Figure from [74]. .....	21
Figure 3.5 General structure of the bi-level problem .....	22
Figure 3.6 Basic concept of the model predictive control.....	24

### TABLES:

Table 3.1 Generator parameters and costs – typical values for a thermal power plant unit.....	19
---	----

## BIOGRAPHY

Ninoslav Holjevac was born on 19<sup>th</sup> October 1989 in Zagreb, Croatia. He finished his elementary school and Zagreb and afterwards graduated the middle school XV Gymnasium also in Zagreb. He started his study at the Faculty of Electrical Engineering and Computing, University of Zagreb in 2008. He graduated with honors in 2013. He started the doctoral study at the Faculty of Electrical Engineering and Computing in 2014 where he has been also employed as a research and teaching assistant. He is currently working on two international scientific projects. His research interests are integration of renewable technologies into the electric power system and distribution network planning and optimization. He is involved in educational activities on different courses in the field of power systems. He has participated in teaching and laboratory exercises. He speaks English, German and knows the basics of the Chinese. He is married and a father of 3 kids.

Ninoslav Holjevac is an author and a coauthor of 10 journal papers and 21 conference papers. He worked on more than 80 technical studies. He was the editor of several conference proceedings.

### Journal papers:

1. Holjevac, Ninoslav; Capuder, Tomislav; Zhang, Ning; Kuzle, Igor; Kang, Chongqing, „Corrective receding horizon scheduling of flexible distributed multi-energy microgrids“, *Applied energy*, 207 (2017), 1; 176-194, doi:j.apenergy.2017.06.045
2. Holjevac, Ninoslav; Soares, Catarina; Kuzle, Igor, „Short-term power system hourly load forecasting using artificial neural networks“, *Journal of Energy*, 66 (2017), 1; 241-254.
3. Klarić, Mario; Kuzle, Igor; Holjevac, Ninoslav, „Wind Power Monitoring and Control Based on Synchrophasor Measurement Data Mining“, *Energies*, 11 (2018), 12; 3525, 23, doi:https://.org/10.3390/en11123525
4. Ivanković, Igor; Kuzle, Igor; Holjevac, Ninoslav, „Algorithm for Fast and Efficient Detection and Reaction to Angle Instability Conditions Using Phasor Measurement Unit Dana“, *Energies*, 11 (2018), 3; 1, 21, doi:10.3390/en11030681
5. Wujing, Huang, Ning Zhang, Chongqing, Kang, Capuder, Tomislav, Holjevac, Ninoslav, “Beijing Subsidiary Administrative Center Multi- Energy Systems: An Optimal Configuration Planning”, *Electric Power System Research*, 2019, vol 179, 2020, early access
6. Brezovec, Miljenko; Kuzle, Igor; Krpan, Matej; Holjevac, Ninoslav, “Analysis and Treatment of Power Oscillations in Hydro Power Plant Dubrava, IET Renewable Power Generation, vol. 14, 1; 80-89, 2020.

7. Holjevac, Ninoslav; Capuder, Tomislav; Kuzle, Igor, „Defining Key Parameters of Economic and Environmentally Efficient Residential Microgrid Operation“, *Energy Procedia*, 105 (2017), 999-1008, doi:10.1016/j.egypro.2017.03.438
8. Ivanković, Igor; Kuzle, Igor; Holjevac, Ninoslav, „Wide Area Information-Based Transmission System Centralized Out-of-Step Protection Scheme“, *Energies*, 10 (2017), 5; 633-1, doi:10.3390/en10050633
9. Ivanković, Igor; Kuzle, Igor; Holjevac, Ninoslav, „Multifunctional WAMPAC system concept for out-of-step protection based on synchrophasor measurements“, *International journal of electrical power & energy systems*, 87 (2017), 77-88, doi:10.1016/j.ijepes.2016.11.005
10. Holjevac, Ninoslav; Capuder, Tomislav; Kuzle, Igor, „Adaptive Control for Evaluation of Flexibility Benefits in Microgrid Systems“, *Energy journal*, 92 (2015), Part 3; 487-504 doi:10.1016/j.energy.2015.04.031

### Conference papers:

1. Holjevac, Ninoslav; Zidar, Matija; Kuzle, Igor, Techno-economic assessment and optimization of the energy storage unit in the distribution network. // *IEEE Eurocon 2019*, Novi Sad, Srbija, 2019.
2. Holjevac, Ninoslav; Capuder, Tomislav; Kuzle, Igor, Model for Defining the Potential and Value of Multi-Energy Microgrid Services to the Low Carbon Power System Operation. // *11th Mediterranean Conference on Power Generation, Transmission, Distribution and Energy Conversion*, Dubrovnik, Croatia, 2019.
3. Wujing, Huang; Ning Zhang; Chongqing, Kang; Capuder, Tomislav; Holjevac, Ninoslav; Kuzle, Igor, Beijing Subsidiary Administrative Center Multi- Energy Systems: An Optimal Configuration Planning. // *11th Mediterranean Conference on Power Generation, Transmission, Distribution and Energy Conversion*, Cavtat, Croatia, 2018.
4. Ivanković, Igor; Kuzle, Igor; Holjevac, Ninoslav, Key Performance Indicies for Angle Stability Protection Function in WAMPAC System. // *2018 IEEE Power & Energy Society, General Meeting, Portland, Oregon, USA, 2018*, DOI: 10.1109/PESGM.2018.8586527
5. Holjevac, Ninoslav; Capuder, Tomislav; Kuzle, Igor; Zhang, Ning; Kang, Chongqing „Modelling Aspects of Flexible Multi-Energy Microgrids. // *2018 Power Systems Computation Conference (PSCC)*, Ireland: IEEE, 2018. pp. 1-7 doi:10.23919/pssc.2018.8442468
6. Ivanković, Igor; Kuzle, Igor; Holjevac, Ninoslav, Dynamic Angle Instability Simulation Framework Based on Reference Model Platform. // *18th IEEE International Conference on Environment and Electrical Engineering*, Palermo: IEEE, 2018. pp. 1-6, DOI: 10.1109/EEEIC.2018.8494354

7. Holjevac, Ninoslav; Capuder, Tomislav; Kuzle, Igor, Korekcijsko planiranje kratkoročnog optimalnog pogona jedinica s pomičnim horizontom fleksibilnih više-energijskih mikromreža. // 13. Savjetovanje HRO CIGRE, Šibenik, Hrvatska, 2017. pp. 1-10.
8. Zidar, Matija; Pavić, Ivan; Holjevac, Ninoslav; Jakšić, Dalibor; Radočaj, Tomislav; Kuzle, Igor, Integracija infrastrukture za punjenje električnih vozila u distribucijsku mrežu Karlovca. // 13. savjetovanje HRO CIGRE, Šibenik, Hrvatska: HRO CIGRE, 2017. pp. 1-9.
9. Ivanković, Igor; Kuzle, Igor; Holjevac, Ninoslav, Algorithm for Out-of-Step Condition Detection and Early Warning Using Phasor Measurement Unit Data. // 2017 IEEE 17th International Conference on Environment and Electrical Engineering IEEE, 2017, Milan: 2017.,pp 1-6
10. Pavić, Ivan; Holjevac, Ninoslav; Zidar, Matija; Kuzle, Igor; Nešković, Aleksandar Transportation and Power System Interdependency for Urban Fast Charging and Battery Swapping Stations in Croatia. // MIPRO 2017, Rijeka, Croatia, pp. 1709-1714
11. Martinsen, Thomas; Holjevac, Ninoslav; Bremdal, Bernt; Kuzle, Igor; Guerrero, Josep; Dragicevic, Tomislav; Pavić, Ivan; Shafiee, Qoabad, Improved grid operation through power smoothing control strategies utilizing dedicated energy storage at an electric vehicle charging station. // CIRED 2016, Helsinki, Finland, 2016. pp. 438-443.
12. Holjevac, Ninoslav; Capuder, Tomislav; Kuzle, Igor, Defining Key Parameters of Economic and Environmentally Efficient Residential Microgrid Operation. // The 8th International Conference on Applied Energy – ICAE2016, Beijing, China, 2016.
13. Holjevac, Ninoslav; Capuder, Tomislav; Kuzle, Igor, Ekonomska i okolišna analiza adaptivno upravljane fleksibilne mikromreže. // 5. savjetovanje Hrvatskog ogranka Međunarodne elektrodistribucijske konferencije, Osijek, Croatia, 2016.
14. Pavić, Ivan; Holjevac, Ninoslav; Jurković, Kristina; Kuzle, Igor, Distribution Network Reliability and Asset Management. // International Conference on Condition Monitoring, Diagnosis and Maintenance 2015 / Cigre Romania, Bucharest, 2015. pp. 205-214.
15. Pavić, Ivan; Capuder, Tomislav; Holjevac, Ninoslav; Kuzle, Igor, Role and Impact of Coordinated EV Charging on Flexibility in Low Carbon Power Systems. // IEEE International Electric Vehicle Conference, Florence, Italy, 2014.
16. Morvaj, Boran; Jurišić, Bruno; Holjevac, Ninoslav, Stochastic simulation of the smart grid and demand response implementations on a city-wide scale. // Rijeka: MIPRO, 2013. pp. 1626-1632
17. Jurišić, Bruno; Holjevac, Ninoslav; Morvaj, Boran, Framework for designing a smart grid testbed. // MIPRO, Rijeka, 2013. pp. 1620-1626
18. Kuzle, Igor; Holjevac, Ninoslav; Capuder, Tomislav, Model Predictive Control for Scheduling of Flexible Microgrid Systems. // 9th Conference on Sustainable Development of Energy, Water and Environment Systems - SDEWES, 2014. pp. SDEWES2014.0087-1.

19. Ivanković, Igor; Kuzle, Igor; Avramović, Boris; Holjevac, Ninoslav, Modeli za dinamičke proračune u prijenosnoj mreži. // 13. Simpozij o vođenju EES-a, HRO CIGRÉ, Zagreb, Croatia 2018. str. 1-10
20. Holjevac, Ninoslav; Pavić, Ivan; Zidar, Matija; Kuzle, Igor, Utjecaj pouzdanosti pogona na održavanje i planiranje razvoja distribucijskog sustava. // 5. savjetovanje Hrvatskog ogranka Međunarodne elektrodistribucijske konferencije, Osijek, Croatia, 2016. pp. 1-7.
21. Holjevac, Ninoslav; Kuzle, Igor; Zidar, Matija; Modrovčić, Mladen, Razvoj modela analitičkog hijerarhijskog procesa i njegovo korištenje pri donošenju odluke o prelasku na 20 kV pogonski napon. // 4. savjetovanje Hrvatskog ogranka Međunarodne elektrodistribucijske konferencije, Trogir/Seget Donji, Croatia, 2014.

## ŽIVOTOPIS

Ninoslav Holjevac rođen je 1989. godine. Sveučilišni preddiplomski studij završio je na Fakultetu elektrotehnike i računarstva Sveučilišta u Zagrebu, profil elektroenergetika 2011. godine. Diplomirao je na Fakultetu elektrotehnike i računarstva Sveučilišta u Zagrebu, profil elektroenergetika 2013. godine. 2014. godine započinje doktorski studij na Fakultetu elektrotehnike i računarstva Sveučilišta u Zagrebu. Trenutno je zaposlen kao asistent na Fakultetu elektrotehnike i računarstva. Profesionalni interesi uključuju planiranje razvoja distribucijskih mreža, integracija obnovljivih izvora energije i upravljanje i modeliranje više-energijskih sustava. Trenutno sudjeluje u radu na dva međunarodna istraživačka projekta. Sudjeluje u izvođenju nastave na predmetima profila Energetika te izradi stručnih studija i elaborata za operatore elektroenergetskog sustava i privatne investitore. Bio je tajnik konferencije IEEE Energycon 2014 te predsjednik organizacijskog odbora konferencije IET Medpower 2018. Dopredsjednik je IEEE PES-a hrvatske sekcije. Govori engleski, njemački i osnove kineskog jezika. Oženjen je i otac troje djece.

Do sada je objavio 10 radova u časopisima, 21 konferencijski rad te preko 80 stručnih studij i elaborata. Dodatno, bio je urednik nekoliko zbornika radova.